



EN

DEHUMIDIFIER

DRY PURY 11 – 13 – 17 – 21 – 25



OPERATING INSTRUCTIONS

Read the instructions carefully before operating or servicing the dehumidifier.
Observe all the safety instructions; failure to observe the instructions may lead to accidents and/or damage.
Keep these instructions in a safe place for future reference.



Appliance filled with flammable gas R290.



Before installing and using the appliance, read the owner's manual.



Before install the appliance, read the installation manual.



Before repair the appliance, read the service manual.

The Refrigerant R290

- To realize the function of the air conditioner unit, a special refrigerant circulates in the system. The refrigerant is the fluoride R290 = 3 GWP (Global warming potential). This refrigerant is flammable and inodorous. It can lead to explosions under certain conditions; however the flammability of this refrigerant is very low and it can be ignited only by fire.
- Compared to other common refrigerants, R290 is a non-polluting refrigerant with no harm to the ozonosphere and a no effect upon the greenhouse effect. R290 has very good thermodynamic features which lead to a really high energy efficiency. The units therefore need less filling.

Warning:

Do not try to accelerate the defrosting process or to clean the appliance in different ways other than those recommended by the manufacturer. Should repair be necessary, contact your nearest authorized Argoclima Service Centre. Any repairs carried out by unqualified personnel may be dangerous. The appliance has to be stored in a room that doesn't have any continuously operating ignition sources. (for example: open flames, an operating gas appliance or an operating electric heater.) Do not pierce or burn.

Appliance has to be installed, operated and stored in a room with a floor area larger than 4 m².

For repairs, strictly follow manufacturer's instructions only for appliances filled with R290 flammable gas. Be aware that refrigerants do not have any odour.

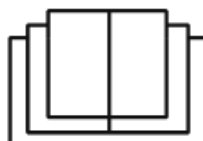

Exception Clauses

Manufacturer will bear no responsibilities when personal injury or property loss is caused by the following reasons.

1. Damage the product due to improper use or misuse of the product;
2. Alter, change, maintain or use the product with other equipment without abiding by the instruction manual of manufacturer;
3. After verification, the defect of product is directly caused by corrosive gas;
4. After verification, defects are due to improper operation during transportation of product;
5. Operate, repair, maintain the unit without abiding by instruction manual or related regulations;
6. After verification, the problem or dispute is caused by the quality specification or performance of parts and components that produced by other manufacturers;
7. The damage is caused by natural calamities, bad using environment or force majeure.

GENERAL OPERATING AND SAFETY INSTRUCTIONS

- **This appliance is a highly efficient dehumidifier, designed for domestic use only!**
- Use this dehumidifier only as outlined in this manual. Any other use not recommended by the manufacturer may cause fire, electric shock or malfunctions.
- The unit contains refrigerant; keep it vertical at all times.
- Once you have opened the unit, keep it vertical to allow the refrigerant to stabilise and wait two hours before operating it.
- Ensure that the required voltage and frequency (220-240V/50Hz) match the available power source.
- This appliance can be used by children aged from 8 years and above and people with reduced physical, sensory or mental capabilities or lack of experience and knowledge if they have been given supervision or instruction concerning use of the appliance in a safe way and understand the hazards involved.
- Children shall not play with the appliance.
- Cleaning and user maintenance shall not be made by children without supervision.
- Make sure the plug is inserted fully. Do not use multiple adapters. Do not touch the plug with wet hands. Make sure the plug is clean.
- Children aged between 3 and 8 years must only be able to turn the appliance on/off, provided that the appliance has been placed in its normal operating position, that instructions have been given on how to use the equipment safely, and that its risks have been understood.
- Children aged between 3 and 8 years must not be able to plug in, adjust, clean or perform any maintenance on the appliance.
- **Disconnect the mains power when the appliance is not in use or during cleaning operations. Keeping the appliance plugged in may cause electric shocks or accidents.**

- To disconnect the appliance, set the switch to OFF and remove the plug from the socket. Only pull on the plug. Do not pull the cord.
- Do not bend, drag or twist the cord, or apply force to remove it. **Do not operate the unit if its cable or plug are damaged; doing so can cause fires or electric shock.** If the power cord is damaged, it must be replaced by a service centre.
- Do not place heavy objects on top of the appliance.
- Do not place the appliance on the carpets, any water leakage could damage them.
- To prevent water spills, empty the water tank before moving the appliance.
- Do not tilt the dehumidifier onto one side or turn it upside down, as the water which runs out could damage the appliance.
- **Do not operate the unit on unstable or sloping surfaces: water leaks can cause it to malfunction or cause excessive vibration and running noise.**
- The dehumidifier must be positioned **at least 50 cm** away from the wall or other obstacles, so that the heat can dissipate correctly.
- **Close all open windows to maximise dehumidification efficiency.**
- **Do not insert objects or sharp instruments into the air outlet grille.**
- **Do not cover the air intake and outlet grilles in any way.**

WARNING!

In the event of an anomaly, switch the appliance off and unplug it immediately. Do not dismantle, repair or modify this product freely. In the event of a malfunction, contact the after-sales service centre directly.

- Do not immerse the power cord, plug or any other part of the appliance in water or other liquids.
- Do not expose the dehumidifier to direct sunlight.

- Do not use the appliance in the bathroom or laundry room.
- Keep the appliance well away from sources of heat which could cause plastic parts to become warped.
- Do not spray insecticides, oils or paints near the appliance; doing so may damage its plastic parts or start a fire.
- **Keep flammable gases and oils away from the appliance!**
- **Do not move the appliance while it is operating; doing so can cause leaks and malfunction.**

DESCRIPTION OF PARTS

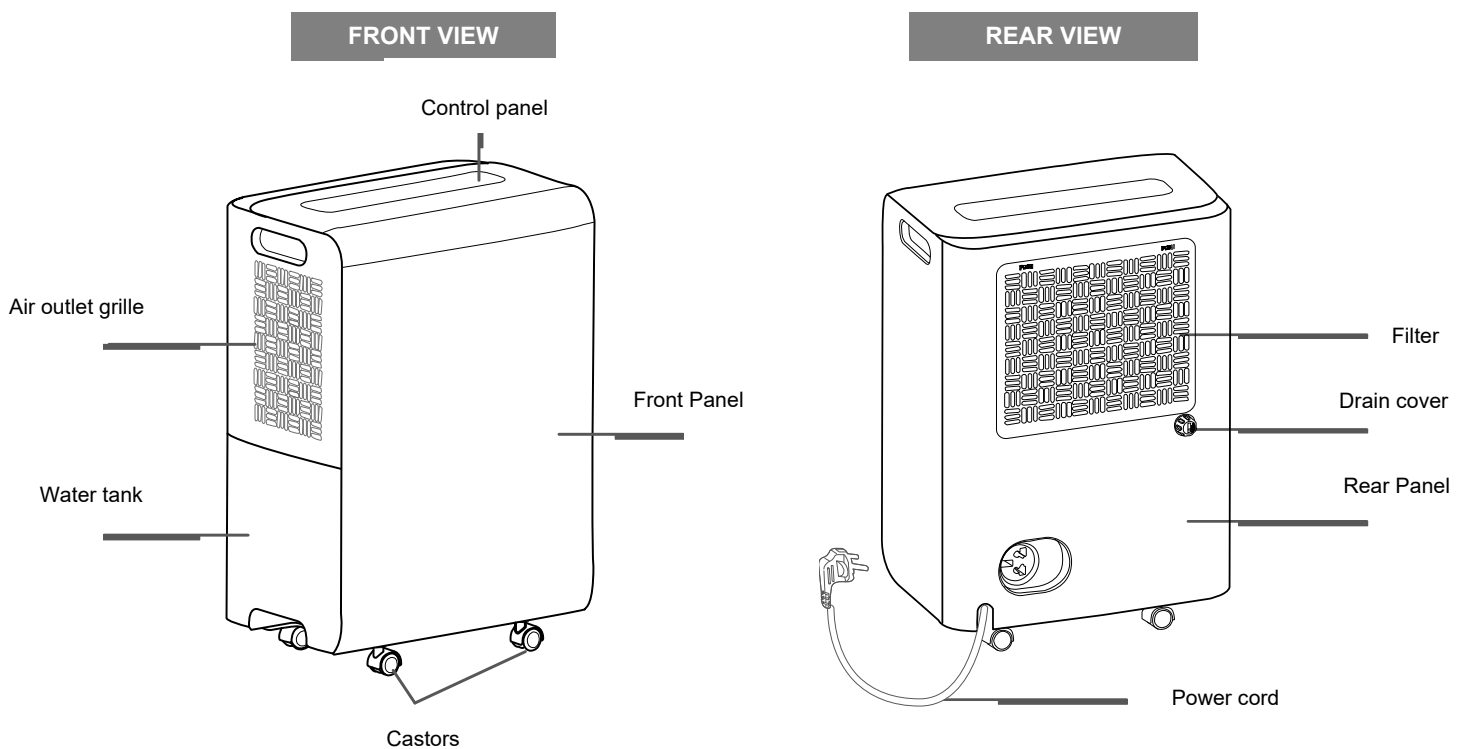

The following space must be maintained to ensure the operating efficiency of the dehumidifier.

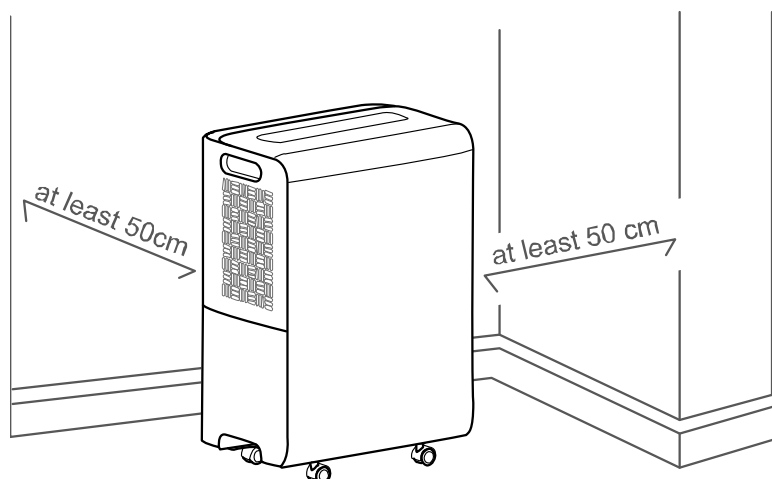

PRE-OPERATING CHECKS AND OPERATIONS

Before operating the appliance, check the correct positioning of the float inside the condensate collection tank.

1. Remove the tank following the direction of the arrow.
2. Remove from the tank the bubble plastic bag which contains the 4 wheels and the cable reel
3. Reposition the tank, closing it perfectly, as shown below

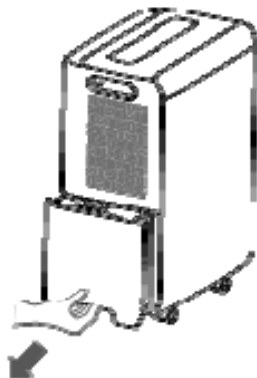

4. Check that the float inside the tank for collecting the condensate is correctly positioned. During transport it may undergo small displacements.

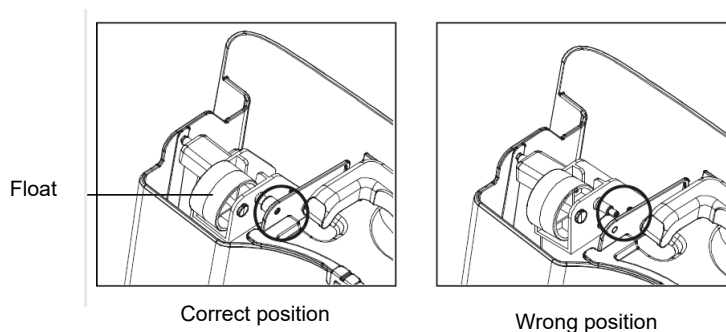

5. Reposition the water tank, closing it perfectly
6. Tilt the dehumidifier no more than 45° and remove the 4 rubber plugs, which will be replaced by 4 wheels that are inside the tank.
7. Position the wheels on the 4 holes and push until the wheels are set firmly in place.

OPERATING INSTRUCTIONS

APPLIANCE START-UP

Place the product on a flat and stable heat-resistant surface, at least 1 metre away from flammable or heat-sensitive materials and 50 cm away from walls or other obstructions.

Make sure the water tank is in the correct position.

Connect the power cord to a suitable electric socket (220-240V/50Hz).

Turn the appliance on with ON/OFF on the control panel.

The unit emits a “beep” signal and the corresponding LED lights up.

The dehumidifier is designed to operate at ambient temperatures from **+ 5°C to + 32°C**.

If it is operated at low temperatures, ice may form on the evaporator, degrading its operation.

When this happens, the dehumidifier goes into defrost mode. The compressor stops, but the fan continues running.

The defrosting operation may start up and operate for some minutes; during the defrosting operation, the dehumidification function may intermit: please don't turn off the switch or pull out the power plug of the dehumidifier.

We recommend not using the dehumidifier in room temperatures lower than 5°C.

Do not remove the tank when the unit is in operation.

If you wish to make continuous draining of condensate, follow the instructions in the dedicated paragraph.

This dehumidifier is equipped with a composite filter for air purification consisting of 3 filters:

Green filter - Catechin filter natural substance extracted from tea, eliminates odors and pollutants
Gray filter - Silver ion filter, eliminates bacteria
Blue filter - Additional filter with anti-bacterial action

The dehumidifier is equipped with a signaling system for the need to clean the dust filter after 250 hours of operation (AIR CLEAN SYSTEM).

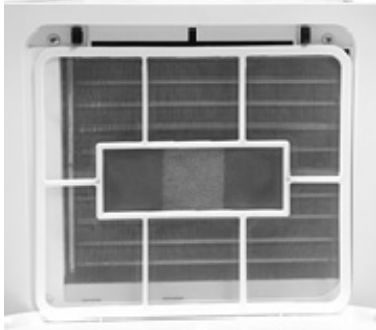

OPERATING PRECAUTIONS

The appliance will only start operating if the humidity level in the room is above the set value.

The dehumidifier will continue to operate until the set humidity level has been reached, **with the exception of interruptions caused by a full tank**. In this case, empty and reinstall the tank: the dehumidifier will now start running again.

WARNING:

After each interruption of its operation, at least 3 minutes must pass before the dehumidifier starts up again: this delay prevents the compressor being damaged.

If, on the other hand, the set humidity percentage is higher than the level currently found in the room, the dehumidifier will not start.

If, after following the appliance start-up instructions, **the dehumidifier does not start and the stand-by (POWER) LED does not come on**, or if the dehumidifier stops for no reason, make sure the plug and power cord are in good working order. After doing so, wait for 10 minutes and then restart the appliance.

If the dehumidifier still does not start after 10 minutes, or if either the power cord or plug are damaged, switch off the appliance and contact an after-sales service centre.

WARNING:

When the dehumidifier is running, the compressor produces heat and the appliance emits warm air into the room. The room temperature will therefore tend to increase. This is completely normal.

TURNING THE DEHUMIDIFIER OFF

To turn the dehumidifier off press the POWER button.

The power supply stops and the compressor stops, even if the ventilation function continues for about 3 minutes, before stopping, then the dehumidifier stops working. Unplug the appliance if you do not intend to use it for some time.

HOW TO ELIMINATE CONDENSATE

The water extracted from the air can be collected in the provided water tank.

When the tank is full, not inserted or not correctly inserted, the FULL TANK led turns on and the unit beeps for about 10 seconds, at the end of which the unit turns off.

Do not use remove the water tank while unit is in operation or if it has just been turned off.

To switch off the appliance, press POWER button and wait a few seconds.

1. Carefully remove the tank and following the direction of the arrow, paying attention to not spill out the water from the tank and then splash onto the floor.

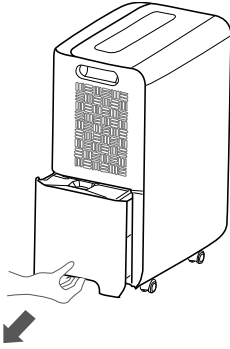

2. Empty the tank.

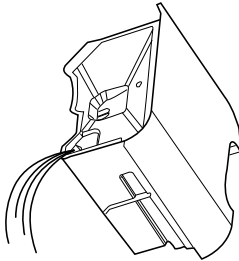

3. Reposition the tank following the direction of the arrow.

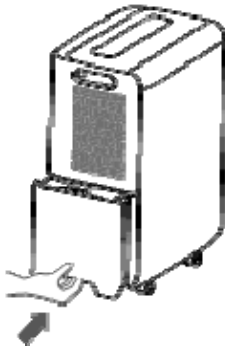

N.B.

Do not use the drain hose when you are collecting condensation in the tank, otherwise water can leak out of the hose.

CONTINUOUS CONDENSATE DRAINAGE

The water can be continuously drained when using a PVC hose with an inner diameter of 14 mm (not supplied). Turn off the appliance and remove the plug before connecting the hose.

Unscrew the drain plug and remove the rubber plug from the unit. Screw the adapter to the unit and firmly connect the PVC hose, making sure it is positioned downwards to allow water to drain. Place a basin under the hose for collecting condensation water. Be careful not to bend the hose otherwise the water cannot be drained.

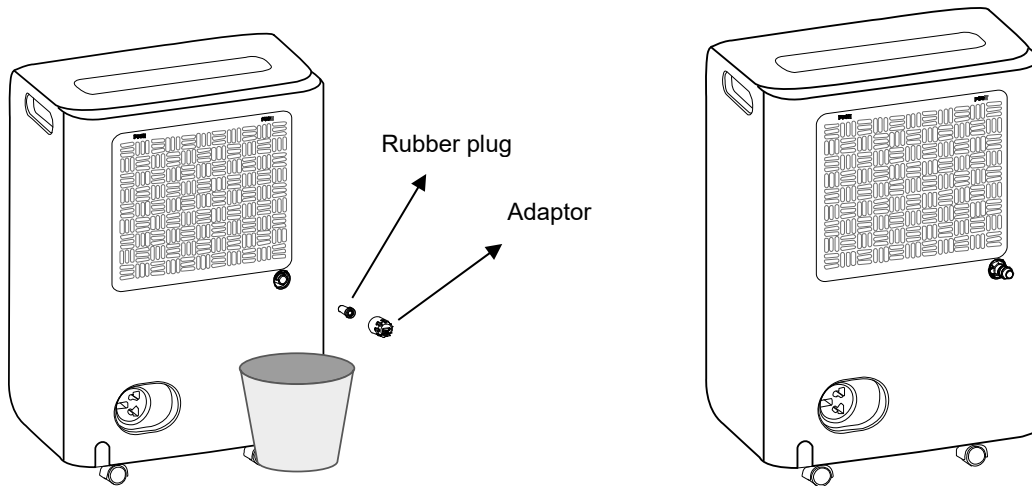

The height of the drainage hose must not exceed that of the hole: do not block the drainage hose exit.

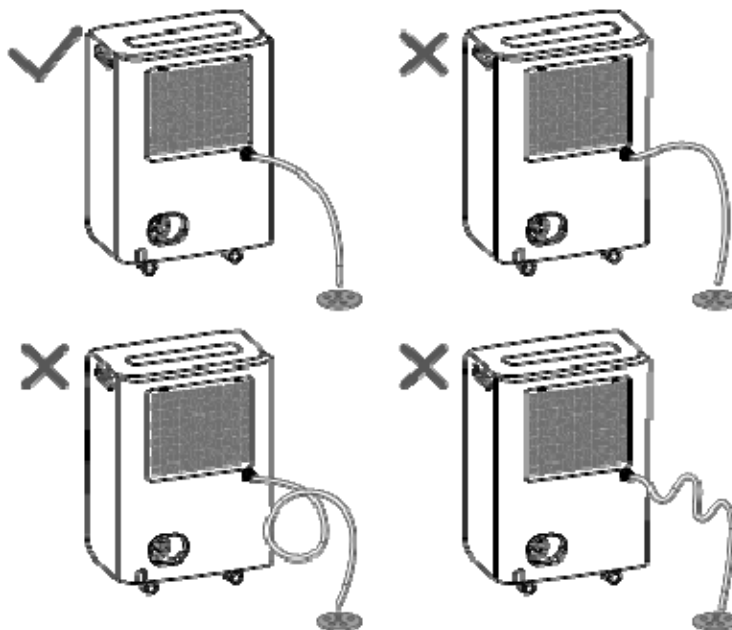

When disconnecting the tube, prepare a container to collect the remaining water from the tube.



CONTROL PANEL

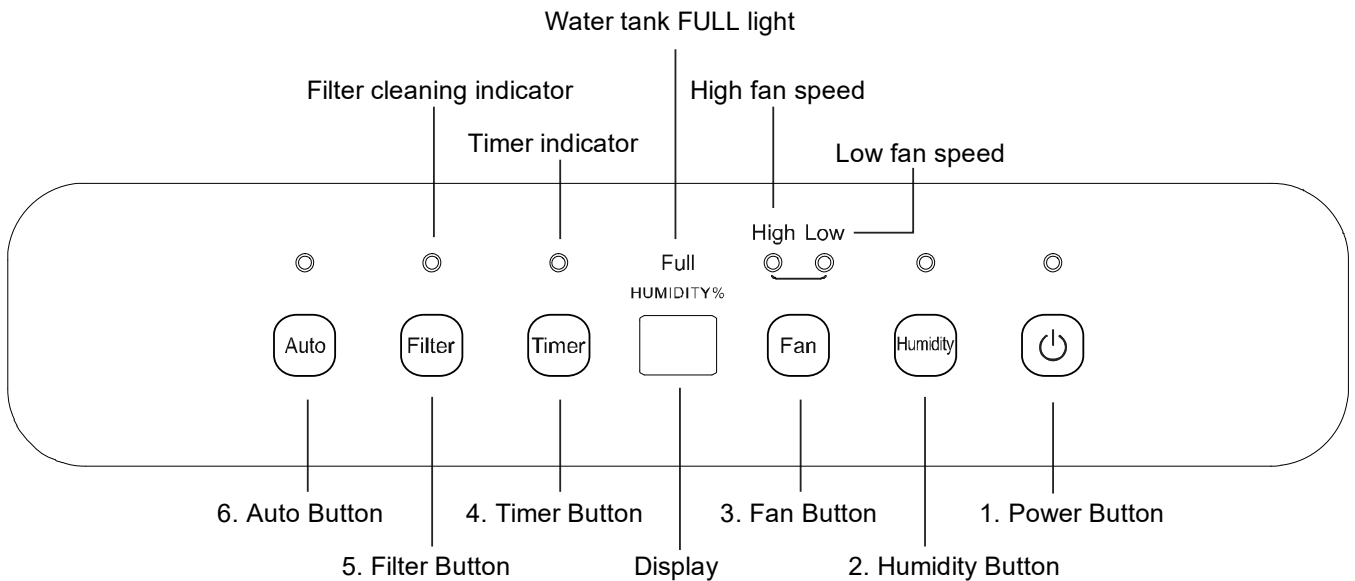

Each time the button is pressed, the unit emits an auditory signal.

BUTTONS & LEDS

1. **POWER BUTTON:** press this button to turn the dehumidifier on and off.
2. **HUMIDITY BUTTON:** press this button to adjust the % of humidity to desired value (30-80%) – each step 5%
3. **FAN SPEED BUTTON:** press this button to adjust the ventilation speed (Low or High). When you need fast dehumidification, select high fan speed, when you need the unit to work quietly, select low fan speed.
4. **TIMER BUTTON:** To program the switching on or off of the appliance. the Timer can be set in the 1-24 hours sequence
5. **FILTER BUTTON:** After 250 hours of operation, the FILTER led turns on to indicate that it is time to clean the filter. Take the filter out and clean it. Then press the FILTER button.
6. **AUTO BUTTON:** Press this button to set the automatic dehumidification mode, when the appliance enters this mode it automatically sets the most comfortable humidity. To exit the automatic dehumidification, just select the humidity with the appropriate button.

DISPLAY

The display shows the humidity present in the environment. Press the Humidity button to select the desired humidity. 5 seconds later it will return to show the humidity detected in the environment.

LED Filter: filter needs to be cleaned.

LED HIGH AND LOW FAN SPEED : it shows the set fan speed: High and Low.

LED TIMER: it shows that the timer is set (sequence 1-24 hours)

LED Full: When the tank is full or it's not correctly positioned the LED Full comes on and flashes, the appliance stops running. A 10 second beep sounds. Remove the tank and empty it (as indicated in "HOW TO ELIMINATE CONDENSATION"), the restore it; the dehumidifier will start running again.

DEFROST: the dehumidifier is designed to operate at ambient temperatures from **+ 5°C to + 32°C**.

If it is operated at low temperatures, ice may form on the evaporator, degrading its operation.

When this happens, the dehumidifier goes into defrost mode. The compressor stops, but the fan continues running.

We recommend not using the dehumidifier in room temperatures lower than 5°C.

MEMORY FUNCTION: the dehumidifier starts up again after a power failure keeping last settings.

AUTOSTOP FUNCTION: if the humidity it's lower than 5% respect to the one set by the humidifier automatically it stop.

CLEANING AND MAINTENANCE

MAINTENANCE OF THE HUMIDIFIER'S EXTERIOR SURFACE

⚠ Warning

Always pull the dehumidifier's plug out of the power socket before cleaning it, to prevent electric shock and malfunction.

⚠ Warning

Do not wet the appliance or immerse it in water, otherwise electric shocks may occur.

Use a damp and soft cloth to clean the exterior surface of the dehumidifier.

Do not use solvents, petrol, xylene, talcum powder or brushes to clean the unit: these may damage the surface or colour of the casing.

CLEANING OF GRILLE AND EXTERIOR SURFACE

To clean the external surface, use a soft cloth. If it is particularly dirty, use a damp cloth, taking care to dry the surface. To clean the air supply grille, use a vacuum cleaner or a soft brush.

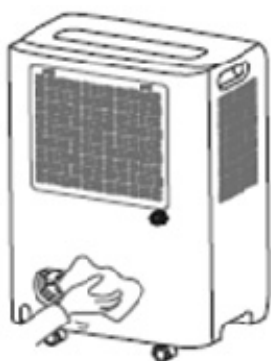

CLEANING THE WATER TANK

We advise removing the tank once every few weeks to prevent mould and bacteria forming on it. Fill the tank with clean water a small amount of detergent; swill the water around in it, then it out and rinse it thoroughly.

CLEANING THE AIR FILTER

The function of the filter is to filter the dust or dirt present in the air. If the filter is blocked by dust, the electrical consumption will be higher than normal.

Do not operate the dehumidifier without having positioned the filter, this could damage the appliance.

The filter should be checked and cleaned at least after 250 hours of operation, or more frequently if necessary.

Cleaning instructions:

Remove the filter by pressing simultaneously on "push" at the top left and right of the filter with 2 hands. Clean the filter with water (the water temperature must not be higher than 45 °C) and let it dry naturally. Place the filter back in its housing.

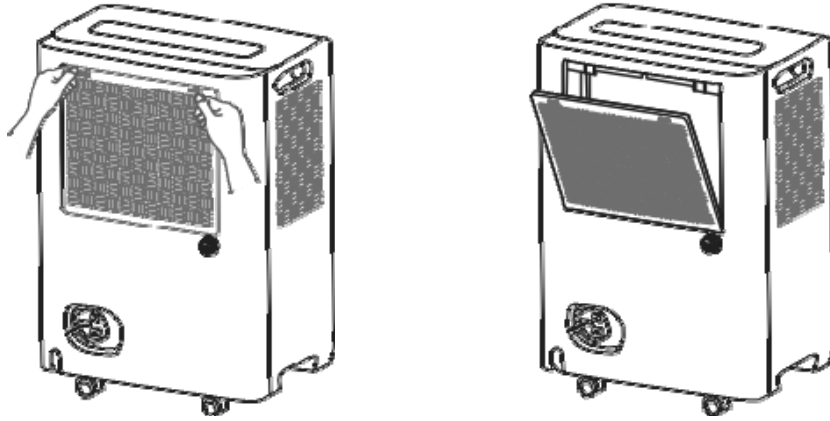

Do not dry the filter with a heat source or with a hairdryer, it could catch fire. Use a vacuum cleaner with the lowest possible power to avoid damaging the fibers. It is advisable to clean the filter every 3 months or more frequently, depending on the frequency of use, for a maximum of 4 cleaning cycles, then it must be replaced.

STORAGE

If the dehumidifier will not be used for a long period of time, carry out the following checks before storing it: 1.

Remove the plug from the socket

2. Make sure that the water tank is empty and that the continuous condensate drain hose is disconnected.

3. Clean the appliance with a soft cloth from any dust deposits

4. Clean the filter

Store the appliance in a cool and dry place away from heat sources.

TROUBLESHOOTING

PROBLEM	POSSIBLE CAUSES	SOLUTION
The dehumidifier does not work. Controls cannot be made.	The temperature is above 32 ° C or below 5 ° C. The internal tank is full. The tank is not positioned correctly. The plug is not connected correctly.	Empty the tank Position the tank correctly. Connect the plug.
Noise suddenly increases during operation	The compressor has just started. Poer supply problem. The unit is positioned on an uneven surface.	Place the unit on a regular and stable surface.
Reduced dehumidification effect	Ambient temperature is too low. The filter is full of dust. Doors and windows are open. The entry and exit of the air are blocked. If the unit operates with a temperature between 5 and 15 ° C, the unit will stop for automatic defrosting. The compressor will stop for short periods. After the defrost the unit will resume normal operation. There may be some appliance in the room that emits steam. The room temperature is too low	Clean the filter. Close doors and windows. Remove objects that block the entry and exit of the air. This appliance should operate with a minimum ambient temperature above 5 ° C

On departure, the air may smell musty	Due to the temperature difference of the heat exchanger, the air can have a strange smell on departure.	
The appliance emits noise	The dehumidifier may emit noise if placed on a wooden floor. If the noise seems like a hiss, it is normal, it is the refrigerant that circulates in the appliance.	
There is water in the tank even when the hose for continuous condensate drainage is used	Check the drain connections. The drain hose is not connected properly.	Connect the hose correctly. Remove the drain hose and replace it.
The LED on Power is not lit although the appliance has been connected to the power supply	There is no power or the plug is not inserted correctly.	Check for power. Check that the electrical circuit and plug are not damaged. Check that the cable is not damaged.
The dehumidifier stops working during the dehumidification process.	The room temperature is too high or too low.	The dehumidifier automatically turns on again when the room temperature returns to being suitable for operation.
The humidity in the room does not decrease.	The environment is too large for the capacity of the appliance. The doors and windows of the room are not closed.	
The LED indicating the full water tank (FULL) is on	The Full LED lights up to remind you that the water tank is full. The tank has been removed or has not been positioned correctly.	Empty the tank Reposition the tank correctly

REGULATION (EU) N. 517/2014 - F-GAS

The unit contains R290, a natural greenhouse gas with global warming potential (GWP) = 3

DRY PURY 11 : Kg. 0,045 = 0,000135 Tonn CO₂ equiv

DRY PURY 13 : Kg. 0,045 = 0,000135 Tonn CO₂ equiv

DRY PURY 17 : Kg. 0,050 = 0,00015 Tonn CO₂ equiv

DRY PURY 21 : Kg. 0,080 = 0,000240 Tonn CO₂ equiv

DRY PURY 25 : Kg. 0,075 = 0,000225 Tonn CO₂ equiv

Do not release R290 into the atmosphere.



INFORMATION FOR THE CORRECT DISPOSAL OF THE PRODUCT IN ACCORDANCE WITH EUROPEAN DIRECTIVE 2012/19/EU

This appliance may not be scrapped with domestic waste at the end of its life cycle. We call your attention to the crucial role played by the consumer in the re-use, recycling and other forms of recovery of such waste.

The appliance must be scrapped by a sorted waste disposal centre or by returning it to the retailer (no charge is levied for this service), when you purchase a new equivalent appliance.

Sorted disposal of electric and electronic equipment prevents the negative effects on the environment and human health resulting from improper scrapping, and also allows the materials from which it is made to be recovered and recycled, with significant savings in terms of energy and resources.

The sorted disposal requirement is indicated by the crossed waste bin label affixed to the appliance.



improve your life

www.argoclima.com