



OPERATING
INSTRUCTIONS

EN

ISTRUZIONI
D'USO

IT

NOTICE
D'UTILISATION

FR

BEDIENUNGS-
ANLEITUNG

DE

INSTRUCCIONES
DE USO

ES

MANUAL
DE INSTRUÇÕES

PT

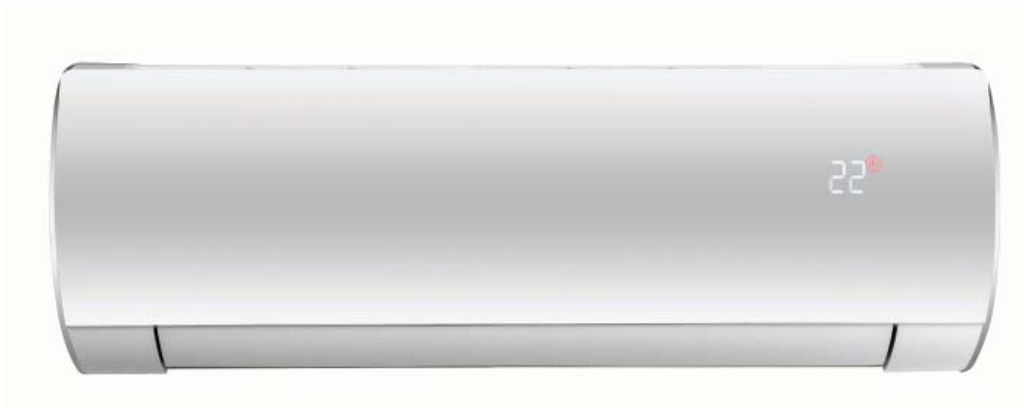

AWIAS19
AWIBS19
AWICS19

Direct expansion indoor unit for ISERIES systems

Unità interna ad espansione diretta per sistemi ISERIES

Unité intérieure à détente directe pour systèmes ISERIES

Inneneinheiten mit Direktverdampfung für ISERIES-Systeme

Unidad interior de expansión directa para sistemas ISERIES

Unidade interior de expansão direta para sistemas ISERIES

NAME OF PARTS AND OPERATION SELECTOR SWITCH	3
INSTALLATION LOCATION	4
ELECTRICAL REQUIREMENTS	4
SAFETY INSTRUCTIONS	4
USING THE REMOTE CONTROL UNIT	4
REMOTE CONTROL UNIT	5
HOW TO SET THE PRESENT TIME	6
COOLING MODE	6
HEATING MODE	6
AUTOMATIC OPERATION	6
DEHUMIDIFYING MODE(DRY)	7
FAN ONLY MODE	7
ADJUSTING THE FAN SPEED	7
AIR IONIZER	7
NIGHT MODE	7
ENERGY SAVING MODE (ECO)	8
TURBO MODE	8
TIMER SELECTION	8
RESET BUTTON	8
HOW TO SET SCHEDULES	8
PARAMETERS SETTING	9
ADJUSTING THE AIR FLOW DIRECTION	11
OPERATION WITHOUT THE REMOTE CONTROL UNIT	12
USE WITH WIRED CONTROLLER (OPTIONAL-NOT SUPPLIED)	13
CARE AND CLEANING	18
TIPS FOR ENERGY SAVING	19
TROUBLESHOOTING	19

PRODUCT INFORMATION

The year of production of this unit is indicated in the Nameplate (see figure below).

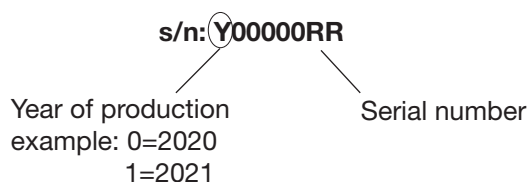

ALERT SYMBOLS

The following symbols used in this manual, alert you to potentially dangerous conditions to users, service personnel or the appliance:



WARNING

This symbol refers to a hazard or unsafe practice which can result in severe personal injury or death.



CAUTION

This symbol refers to a hazard or unsafe practice which can result in personal injury or product or property damage.

NOTE

This air conditioner is equipped with cooling, drying, heating and fan only functions. Details on these functions are provided below; refer on these descriptions when using the air conditioner.

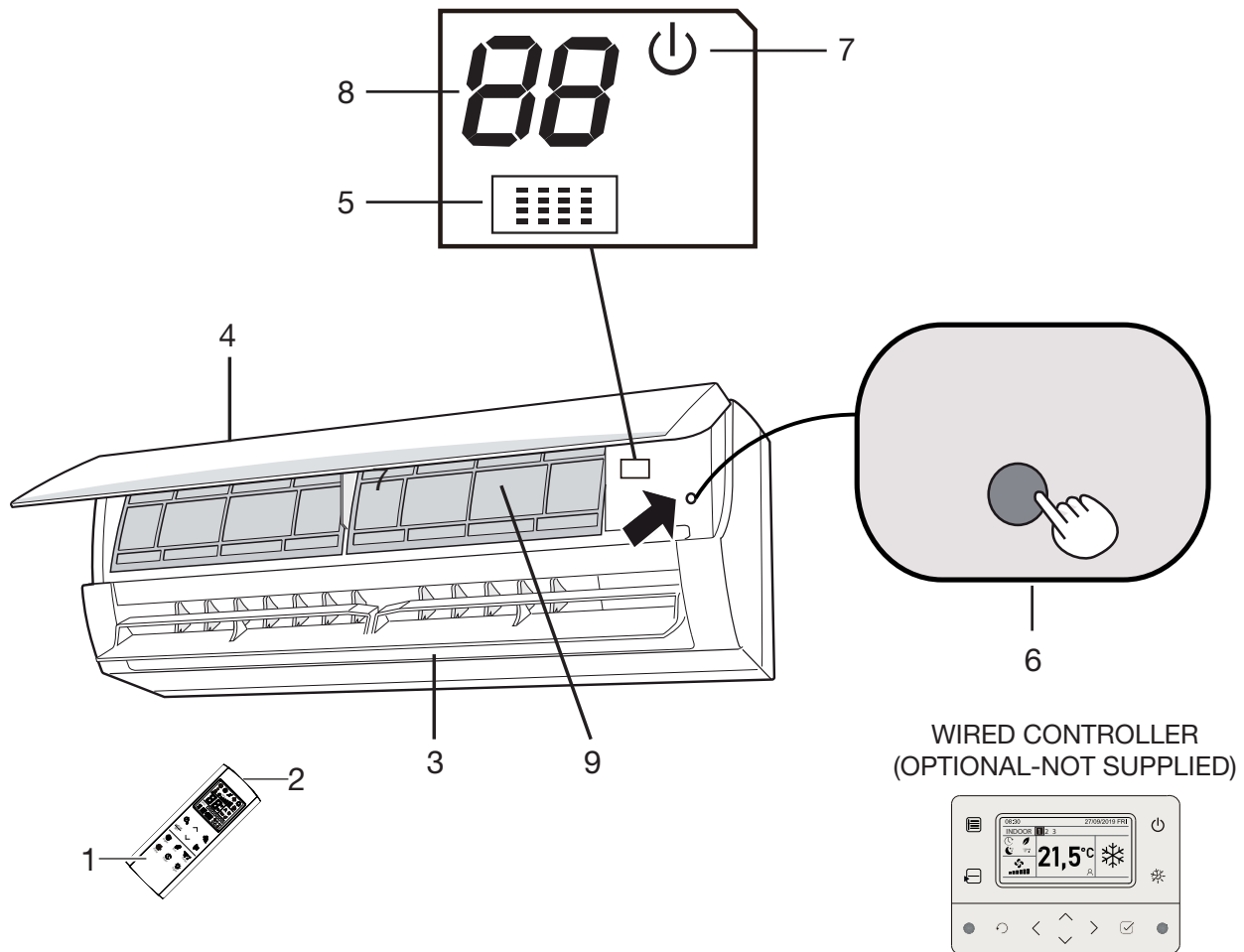

1. **Remote control unit.**
2. **Remote control sensor:** It detects the room temperature around the remote control unit.
3. **Air outlet:** Conditioned air is blown out of the air conditioner through the air outlet.
4. **Air intake:** Air from the room is drawn into this section and passes through air filter which removes dust.
5. **Remote control receiver:** This section picks up infrared signals from the remote control unit (Transmitter).
6. **Operation selector (without remote control):** Push the button to walk through the operation modes (OFF, COOL and HEAT)

9. **Indoor unit sensor:** It detects the room temperature around the indoor unit.

NOTES

- It is possible to set the air conditioner in order to let all the lamps always OFF, even during operation. (See Light)
- In case of troubleshooting the air conditioner diagnostic system activates the lamps accordingly, even if they are set to OFF. See paragraph TROUBLESHOOTING for further details.



WARNING

The OFF selection does not disconnect the power. Use the main power switch to turn off power completely.

7. **OPERATION lamp:** This lamp lights up when the unit is in standby (red led), it turns off during operation.
8. **Room temperature and operating error lamp:** This lamp shows the room temperature or the eventual operating error codes (see table "AUTO DIAGNOSIS").

Every time that the remote control signal is received, this lamp shows the set temperature (setpoint).

INSTALLATION LOCATION

- This air conditioner must be installed by qualified installation technicians in accordance with the installation instructions provided with the unit.



WARNING

- Do not install this air conditioner where there are fumes or flammable gases, or in an extremely humid space such as a green house.
- Do not install the air conditioner where excessively high heat-generating objects are placed.
- Do not install the air conditioner where the atmosphere is extremely damp or humid (e.g. greenhouse or laundry) it could be wetted by drops of water (i.e. in laundries).
- To protect the air conditioner from heavy corrosion, avoid installing the outdoor unit where salty sea water can splash directly onto it or in sulphurous air near a spa.

ELECTRICAL REQUIREMENTS

- Before installation, check that the voltage of the electric supply in your home or office is the same as the voltage shown on the nameplate.
- All wiring must conform to the local electrical codes. Consult your dealer or a qualified electrician for details.
- Each unit must be properly grounded with a ground (or earth) wire or through the supply wiring.
- Wiring must be done by a qualified electrician.

SAFETY INSTRUCTIONS

- Read this booklet carefully before using this air conditioner. If you still have any difficulties or problems, consult your dealer for help.
- This air conditioner is designed to give you comfortable room conditions. Use this only for its intended purpose as described in this Instruction Manual.



WARNING

- Never use or store gasoline or other flammable vapor or liquid near the air conditioner. It is very dangerous.
- Never install electrical equipment, which is not protected with IPX1 protection (protection against vertical water drop), under the unit.
- The manufacturer assumes no responsibilities if the safety regulations or local codes are not observed.



CAUTION

- Never use the power main switch to start or stop the air conditioner: always use the ON/OFF button on the remote control unit or the selector switch on the unit.
- Do not let children play with the air conditioner.
- Do not cool the room too much if babies or invalids are present.
- This air conditioner is not intended for use by persons (including children) with reduced physical, sensory or mental capabilities, or lack of experience and knowledge, unless they have been given supervision or instruction concerning use of the air conditioner by a person responsible for their safety.

USING THE REMOTE CONTROL UNIT

HOW TO INSTALL BATTERIES

- Remove the lid in the rear part of the remote control unit.
- Insert two AAA alkaline batteries of 1,5 V-DC making sure that point in the direction marked in the battery compartment.
- Set the clock (see procedure on page 6). Remote controller is now ready for operation.
- The batteries last average more than six months, anyway it depends on how much you use the remote control unit. Remove the batteries if you do not use the remote control unit for more than one month. Replace the batteries when the battery symbol appears on the remote control (☐)
- The batteries of the remote control contain polluted substances. Exhausted batteries must be disposed according to the laws in force.

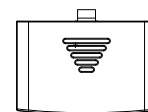
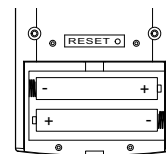

HOW TO REMOVE BATTERIES

- Remove the lid.
- Press the battery toward the negative end and lift it out by its positive end (as shown in the figure).
- Remove the other battery in the same way.

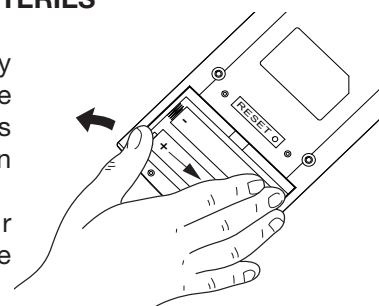

NOTE

ONLY IF YOU INSTALL MORE THAN ONE INDOOR UNIT IN THE SAME ROOM

Set unit 1, 2, 3 or 4 with Remote Control (see procedure in Installation Manual).

TEMPERATURE SENSOR SELECTOR

- Under normal conditions the room temperature is detected and checked by the temperature sensor placed in the remote controller (I FEEL icon displayed). This function is designed to provide a comfortable room temperature by transmitting the temperature control command from the location next to you. When using this function, the remote control should always be pointed at the air conditioner, therefore it should be placed in a position in which it is visible by the indoor unit (for example, do not put it in a drawer).
- It is possible to disable the remote controller room sensor by pressing and holding the FAN/I FEEL icon button. In this case the I FEEL icon on the remote controller display lights off and only the sensor placed in the air conditioner becomes active.

NOTE

The remote control unit transmits signals to the indoor unit each time you press a key and at any temperature change detected by the internal sensor. In case of troubles (low batteries, remote control placed in a position not visible by the indoor unit,...) room temperature control is automatically switched to the sensor of the indoor unit. In this case, the temperature around the remote control unit may differ from the temperature detected in the air conditioner position.

OPERATION WITH THE REMOTE CONTROL UNIT

When using the remote control unit, always point the unit transmitter head directly at the air conditioner receiver.

REMOTE CONTROL UNIT

DISPLAY

Information described below is displayed:

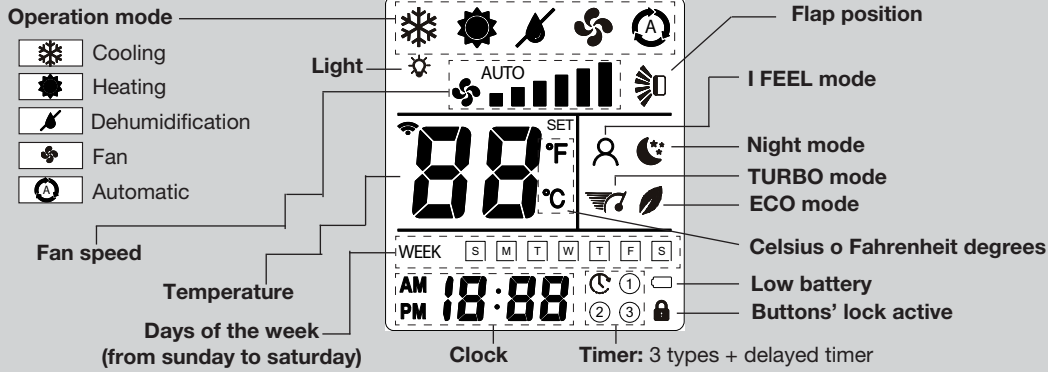

ON/OFF BUTTON

Press this button to turn the air conditioner ON / OFF.

Press for 2 seconds to lock / unlock the buttons

MODE SELECTOR BUTTON

Press this button to modify the air conditioner mode.

COOLING

The air conditioner makes the room cooler.

HEATING

The air conditioner makes the room warmer.

DEHUMIDIFYING (DRY)

The air conditioner reduces the humidity in the room.

FAN

The air conditioner works only as a circulation fan.

AUTOMATIC

When this setting is selected, the unit calculates the difference between the thermostat setting and the room temperature and automatically switches to the "cooling" or "heating" mode.

NIGHT BUTTON

Press this button in order to select the NIGHT mode.

ECO BUTTON

Press this button in order to select the ECO mode.

FILTER BUTTON

Press this button in order to activate the air ionizer built into the unit

CLOCK AND TIMER SETTING BUTTON

Press this button in order to select the desired timer.

Press for 2 seconds to set the timer
For details refer to paragraphs "HOW TO SET THE PRESENT TIME", "TIMER SELECTION", and "SETTING THE TIMER".

TRANSMITTER

When you press the buttons of the remote control unit, the mark appears on the display to transmit the setting changes to the receiver in the air conditioner.

SENSOR

A temperature sensor inside the remote control unit detects the room temperature. (see on the back of the remote control unit)

FAN BUTTON

Press this button to change the fan speed.

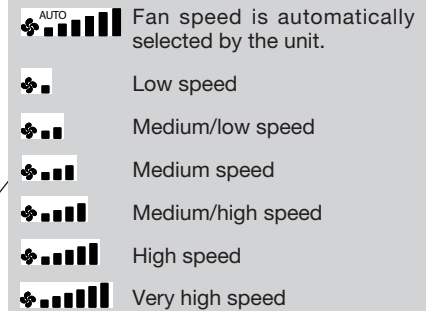

IFEEL MODE

Press this button for a few seconds to modify the temperature sensor selection (from remote controller to air conditioner and viceversa).

TEMPERATURE SETTING BUTTONS

(cooler)

Press this button to decrease the set temperature.

(warmer)

Press this button to increase the set temperature.

USE THESE BUTTONS ALSO TO SURF THROUGH TIMER AND PARAMETERS' SETTING

FLAP BUTTON

Press this button in order to select the desired flap operation.

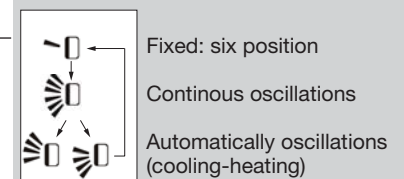



LIGHT BUTTON

Press this button to turn the unit display on or off





TURBO BUTTON

Press this button in order to select the TURBO mode.

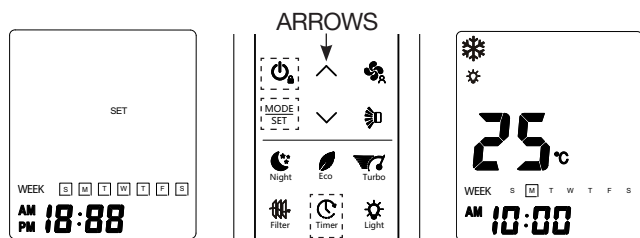



HOW TO SET THE CLOCK

- Press for a few seconds the Timer button  .
Press the button  .



- AM or PM starts flashing: use the arrows to choose AM or PM, then confirm with  .
The hour indication starts flashing: set the hour with the arrows, then confirm with  .
The minutes indication starts flashing: set the minutes with the arrows, then confirm with  .
WEEK starts flashing: set the day of the week with the arrows, then confirm with  .
- At this point the procedure is finished: press the button  to exit the clock menu.

COOLING MODE

- Turn on the unit with the ON / OFF button.
- Press the button  until the COOLING symbol  appears on the display.
- Press the buttons   to set the desired temperature (the temperature range is between 10 °C and 32 °C).

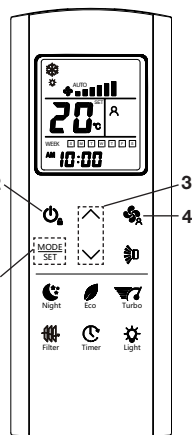

20^{SET}°C THE DISPLAY SHOWS THE SELECTED TEMPERATURE AND THE WORD "SET".





25^{°C} AFTER 5 SECONDS FROM THE REQUIRED TEMPERATURE SETTING THE DISPLAY WILL SHOW THE ROOM TEMPERATURE AGAIN.

- Press the button  to select the fan speed.

NOTES

- If the fan is set in automatic mode and the unit stops because setpoint is reached, also the fan will stop.
- If the fan is set in one of the six manual speeds, it will go on operating at the selected speed, even if the unit stops due to reaching the setpoint.
- When the external or internal temperature is too low, the unit could limit the speed of the compressor or switch it off for a certain period of time to avoid the formation of ice on the internal heat exchanger.

HEATING MODE

- Turn on the unit with the ON / OFF button.
- Press the button  until the HEATING symbol  appears on the display.
- Press the buttons   to set the desired temperature (the temperature range is between 10 °C and 32 °C).

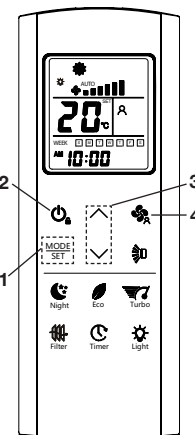

20^{SET}°C THE DISPLAY SHOWS THE SELECTED TEMPERATURE AND THE WORD "SET".

25^{°C} AFTER 5 SECONDS FROM THE REQUIRED TEMPERATURE SETTING THE DISPLAY WILL SHOW THE ROOM TEMPERATURE AGAIN.

- Press the button  to select the fan speed.

NOTE

- If the unit stops because setpoint is reached, also the fan will stop.





COLD DRAFT PREVENTION

When starting the unit the fan may stop until the indoor heat exchanger coil has warmed up sufficiently. This is because the COLD DRAFT PREVENTION SYSTEM is operating. During this period, the OPERATION lamp remains lit (red led).

DEFROSTING OF OUTDOOR UNIT HEAT EXCHANGER

When the outdoor temperature is low, frost or ice may appear on the heat exchanger coil, reducing the heating performance. When this happens, an appropriate defrosting cycle of the exchanger is activated. During this function operation, the fan of the indoor unit stops. Heating operation restarts after several minutes. (This interval will vary slightly depending on the room and outdoor temperature).

AUTOMATIC OPERATION

- Turn on the unit with the ON / OFF button.
- Press the button  until the AUTO symbol  appears on the display.
- Press the buttons   to set the desired temperature (the temperature range is between 10 °C and 32 °C).

20^{SET}°C THE DISPLAY SHOWS THE SELECTED TEMPERATURE AND THE WORD "SET".

25^{°C} AFTER 5 SECONDS FROM THE REQUIRED TEMPERATURE SETTING THE DISPLAY WILL SHOW THE ROOM TEMPERATURE AGAIN.

The air conditioner will automatically operate by switching from heating to cooling operation (or vice versa) in order to maintain the set temperature.

4. Press the button  to select the fan speed.

Example of operation diagram in the  (Auto) mode with the set room temperature at 23°C.

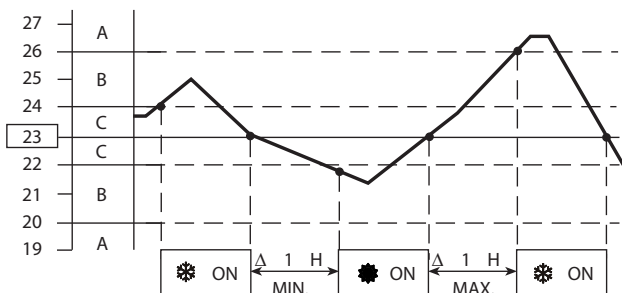





NOTE

The air conditioner changes the operation mode (from cool to heat or vice versa, if one of the following conditions occurs:

- **ZONE A:** changes if the difference between the room temperature and the temperature set on the remote control unit is at least 3°C.
- **ZONE B:** changes if the difference between the room temperature and the temperature set on the remote control unit is at least 1°C, one hour after the compressor stop.
- **ZONE C:** never changes if the difference between the room temperature and the temperature set on the remote control unit is no more than 1°C.

DEHUMIDIFYING MODE (DRY)

1. Turn on the unit with the ON / OFF button
2. Press the button  until the DEHUMIDIFYING symbol  appears on the display.
3. Press the buttons   to set the desired temperature (the temperature range is between 10 °C and 32 °C).



 THE DISPLAY SHOWS THE SELECTED TEMPERATURE AND THE WORD "SET".

 AFTER 5 SECONDS FROM THE REQUIRED TEMPERATURE SETTING THE DISPLAY WILL SHOW THE ROOM TEMPERATURE AGAIN.

NOTES



- Use DRY operation when you want to reduce the humidity in the room.
- Once the room temperature reaches the set level, the unit repeats the cycle of turning on / off automatically.
- During DRY operation, the fan speed is automatically set (Remote control lamp  is ON) to maximize dehumidification.
- When the room temperature drops below the set temperature, the unit still continues to operate at a low temperature and could therefore further reduce the room temperature in small rooms.
- Dry operation is not possible if the indoor temperature is less than 10 °C.

FAN ONLY MODE

If you want to make air circulate without any temperature control, press the button  until the FAN symbol  appears on the display.

ADJUSTING THE FAN SPEED

AUTOMATIC

Set with the button  the "AUTO" position . The unit automatically controls the fan speed. When the air conditioner starts operating, the fan speed varies according to the thermal load of the room.

NOTE

In FAN ONLY mode, the AUTOMATIC speed corresponds to the high speed H.



MANUALE

If you want to manually adjust the fan speed just set the button  as desired:



L	Low	MH	Medium-high
ML	Medium-low	H	High
M	Medium	VH	Very high

AIR IONIZER

Pressing the  button (symbol  on the display) the air ionizer is activated; this is very effective to prevent bad odours and to eliminate bacteria and micro-organisms.



NOTE

The filter is active only if the internal fan is operating.

NIGHT MODE

This program is used to increase silence and comfort during the night.

To activate the Night mode:

1. Press the button  to set the air conditioner in cooling, dehumidifying or heating.
2. Press the button .
3. The symbol  appears on the display. Press the button again to release the function.

What does the NIGHT mode mean?

When you select the NIGHT mode, the air conditioner will modify automatically the set temperature after 60 minutes. This enables you to save energy without sacrificing your comfort.

OPERATING MODE	SET TEMPERATURE CHANGE
Heating	Lowered by 2 °C
Cooling and Dry	Raised by 1 °C

NOTA



During the night mode the internal fan speed is automatically lowered and reduces the noise.

ENERGY SAVING MODE (ECO)

This program is used to limit the maximum electrical power absorbed by the unit.

When the energy saving program is selected, the air conditioner limits the absorbed power to 75% of the maximum power. This limit can be set by modifying parameter P12 on the remote control (see paragraph "Parameters setting").

To activate the Energy save mode:

1. Press the button  to set the air conditioner in cooling or dehumidification.
2. Press the button .
3. The symbol  appears on the display. Press the button again to release the function.



NOTE

This function is active only if the outdoor unit has an updated software version.



TURBO MODE

This program is used to increase the maximum power that can be supplied by the air conditioner, even if it involves less silence.

To activate the Turbo mode:

1. Press the button  to set the air conditioner in cooling.
2. Press the button .
3. The symbol  appears on the display. Press the button again to release the function.

TIMER SELECTION

To select the timer, press the button  to switch on the remote control, then press the button  to choose the desired schedule:

 delayed timer → ① → ② → ③ or "OFF"
timer schedule

NOTE

In the event of a power failure and restoration, the timer selection must be performed again.

RESET BUTTON







Press the RESET button on the back of the remote control if you want to reset all settings and return to the factory setting.



HOW TO SET SCHEDULES

A) DELAYED TIMER

This timer is used to start the unit (if it is off) or to stop the unit (if it is on) after a certain time, to set the delayed time.

1. Press the Timer  button for a few seconds.
2. Press the arrow "up"  to select the delayed timer .
3. Press the button : the hour indication starts flashing; set the hour with the arrows.
4. Press the button  again: the minutes indication starts flashing; set the minutes with the arrows.
5. Confirm with the button , then press the button  to exit the delayed timer menu.













ARROWS



B) SCHEDULE

This timer is used to turn the unit on and off at predefined times and days.

1. Press the Timer  button for a few seconds.
2. Press the arrow "up"  to select the schedule to be set (①, ② or ③).
3. Press the button : ON indication starts flashing.
4. Press the button  again: AM indication starts flashing (you can choose AM or PM with the arrows).
5. Press the button : the hour indication starts flashing; set the desired hour with the arrows.
6. Press the button  again: the minutes indication starts flashing; set the minutes with the arrows.
7. Press the button : OFF indication starts flashing.
8. Repeat the same procedure to set AM or PM, hour and minutes.
9. At this point, press the "up"  arrow and WEEK will start flashing.
9. Press the button : the indication of the first day of the week starts flashing; set ON or OFF with the arrows, then confirm with the button .
9. The indication of the second day of the week starts flashing: repeat the procedure with every day of the week, if desired.
10. At the end press  to exit the menu.



ARROWS



NOTE

- It is possible to set up to 3 weekly schedules at different times using the timers.

To access to the “Parameter menu”, long press “MODE/SET” from the main screen or from the OFF screen:

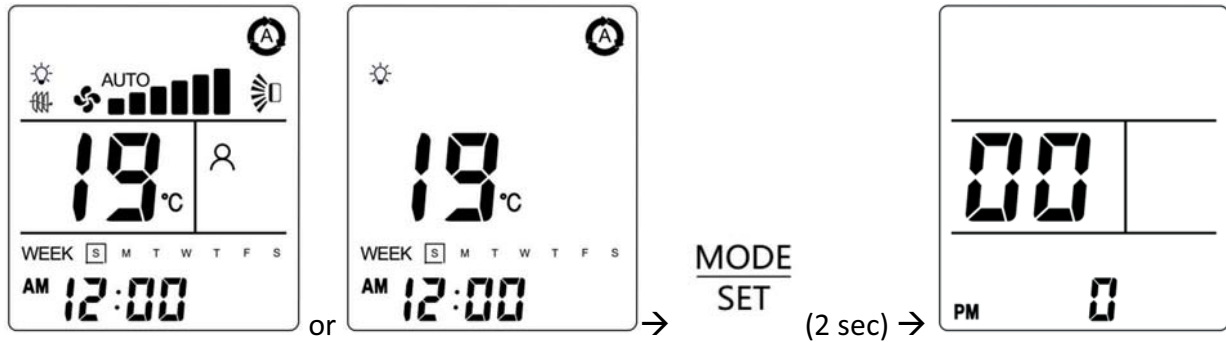

The first parameter shown is P00. Press “UP” or “DOWN” to scroll the parameter list:

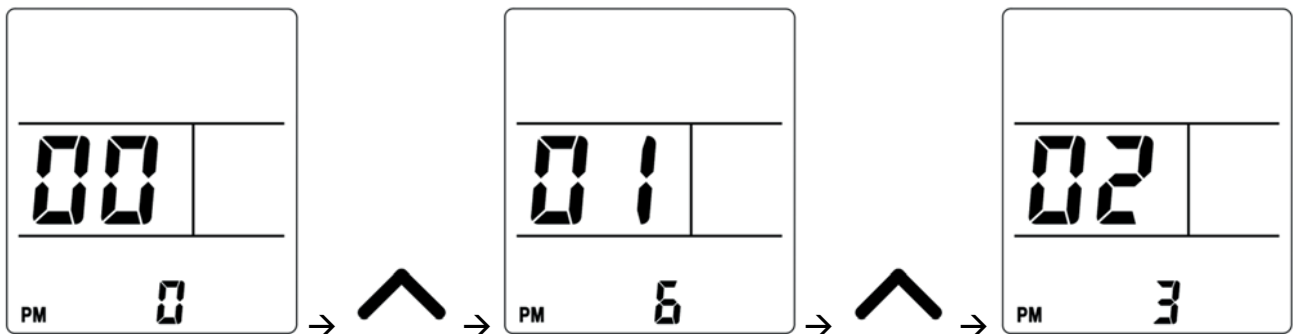

When a parameter has been selected, long press “MODE/SET” to modify the value of the parameter. The value of the parameter starts blinking and SET symbol switches on:

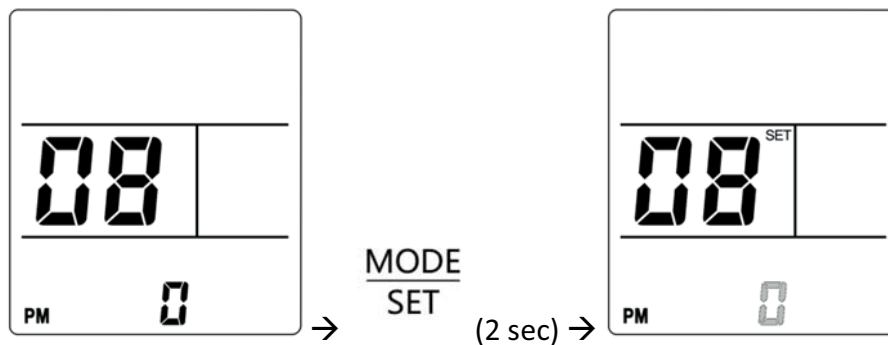

Press “UP” or “DOWN” to modify the value of the parameter, then press “MODE/SET” to save and transmit the selected value of the parameter or press “ON/OFF” to restore the previous value of the parameter:

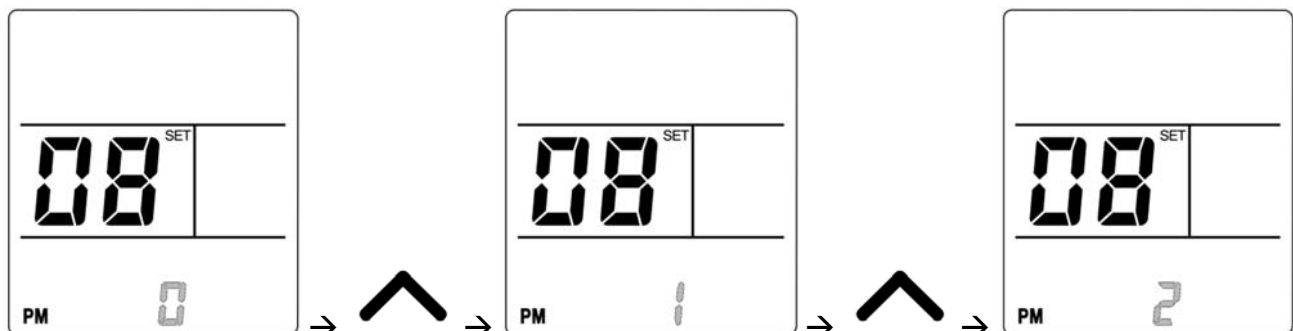

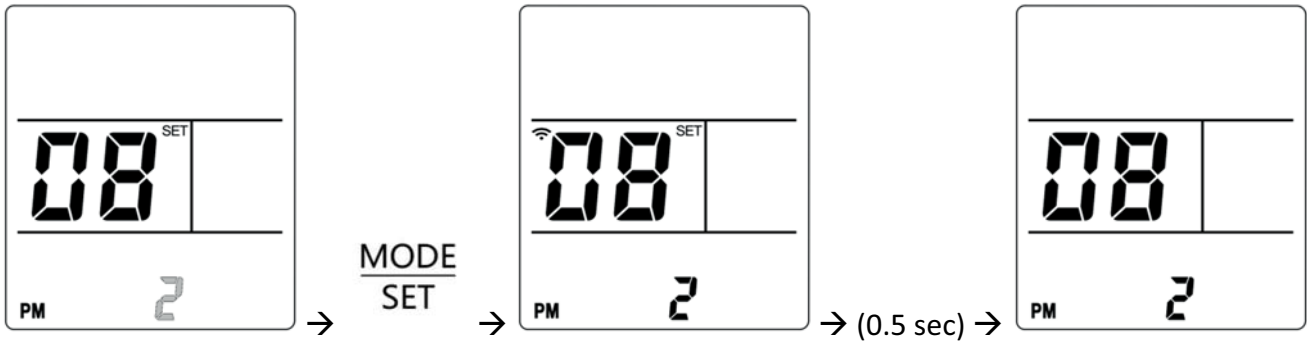

Press "ON/OFF" to go back to main screen:

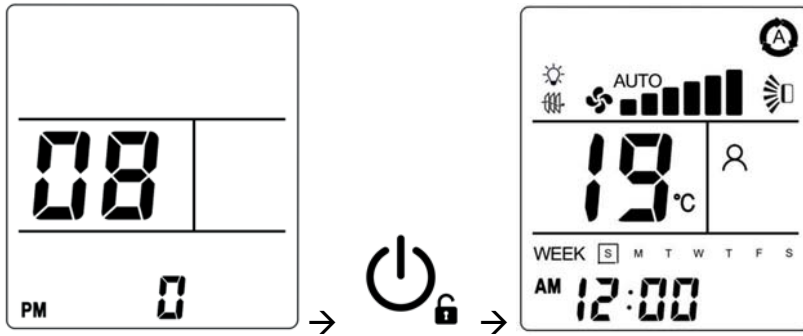

Par.	Parameter name	Min	Default	Max	Values
P00	Factory default reset	0	0	3	0 = No action 1 = Reset all remote control parameters to factory default value 2 = Reset all unit parameters to factory default value
P01	Software version	0	-	7	Software version of the remote controller
P03	Carrier frequency infrared signal	0	0	1	0 = 33 kHz 1 = 38 kHz
P05	Temperature scale	0	0	1	0 = °C (Celsius) 1 = °F (Fahrenheit)
P06	Transmission channel	0	0	3	0 = Channel #0 1 = Channel #1 2 = Channel #2 3 = Channel #3
P08	Communication address/refrigerant circuit	0	0	8	See installation manual. Do not modify during operation.
P09	Humidity threshold setting	0	50	99	Threshold % relative humidity
P12	ECO mode power input limit	30	75	99	When ECO mode is selected, max electrical power input of the unit is limited to P12: 30 = 30% of Max Power Input 31 = 31% of Max Power Input ... 99 = 99% of Max Power Input
P13	Room Air Temperature heating shift	0	3	10	0 = 0°C 1 = 1°C ... 10 = 10°C This parameter can be modified according to the stratification of the air during heating operation
P30	Special command	0	0	1	1=activation of auto-addressing procedure

NOTE

Parameters not listed in the table are reserved and should not be changed. Changing the parameters not listed can cause the air conditioner to malfunction.

ADJUSTING THE AIR FLOW DIRECTION

HORIZONTAL (manual)

The horizontal air flow can be adjusted by moving the lever to the left or right, as indicated in the following figure.

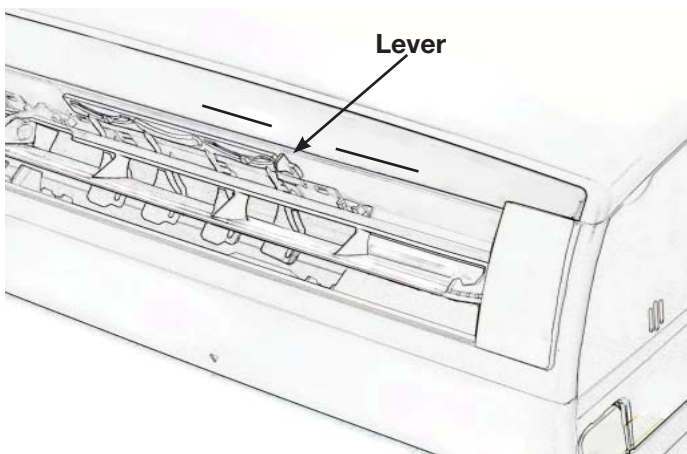

VERTICAL (with remote control unit)

Make sure that the remote control unit has been turned on. Press the FLAP button to select the flap function

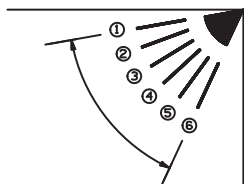
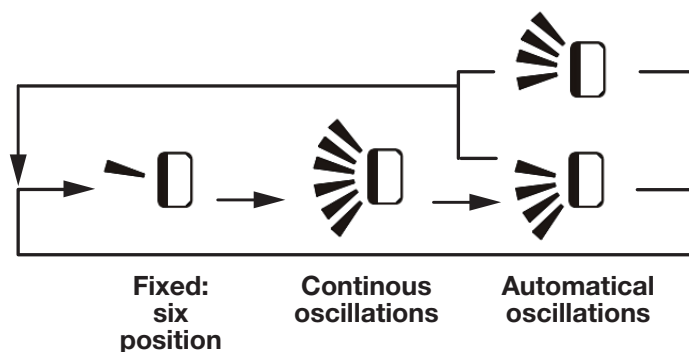

FLAP	MODE

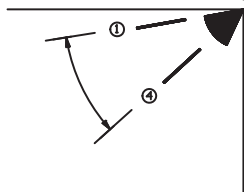

FLAP	MODE

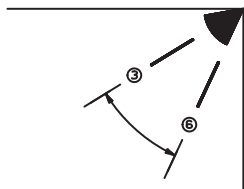

FLAP	MODE

NOTES

- The flap automatically closes when the unit is off.
- When the unit starts in heating operation, the fan stops and the flap is in the 4 position (if automatical oscillation is selected) until the air being blown out of the unit begins to warm. Once the air warms up, the flap position and fan speed change to the settings specified with the remote control.



CAUTION

Do not move the flap with your hands when the air conditioner is running.



CAUTION

- Use the FLAP button on the remote control to adjust the position of the flap. If you move the flap by hand, the factual flap position and the flap position on the remote control may no longer match. If this should happen, shut off the unit, wait for the flap to close, and then turn on the unit again; the flap position will now be normal again.
- Do not have the flap pointed down during cooling operation. Condensation may begin to form around the air vent and drip down.

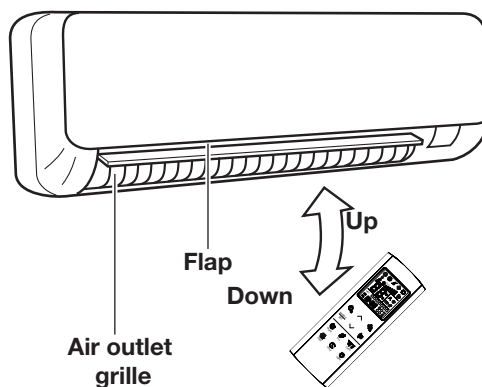

HOW TO ADJUST THE FLAP DIRECTION

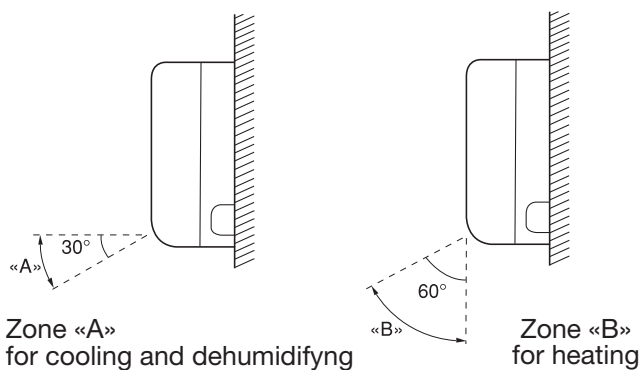

CAUTION

Set vertical vanes to the front position during COOLING/ DRY operation if humidity is high. If the vertical vanes are set to the left-most or right-most position, condensation will form around the air outlet and drip off.

EN OPERATION WITHOUT THE REMOTE CONTROL UNIT

If you have lost the remote control unit or it has troubles, follow the steps below.

1. WHEN THE AIR CONDITIONER IS OFF
If you want to turn on the air conditioner push the OPERATION selector to select the desired mode (COOL or HEAT).

NOTE

The air conditioner will start in HIGH fan speed.
The temperature setting is 25°C for cooling mode and 21°C for heating mode.

2. WHEN THE AIR CONDITIONER IS ON
If you want to turn off the air conditioner push the OPERATION selector until the unit is in standby (red operating lamp).

NOTE

Power failure during operation.
In the event of power failure, the unit will stop. When the power is resumed, the unit will restart automatically after 3 minutes.

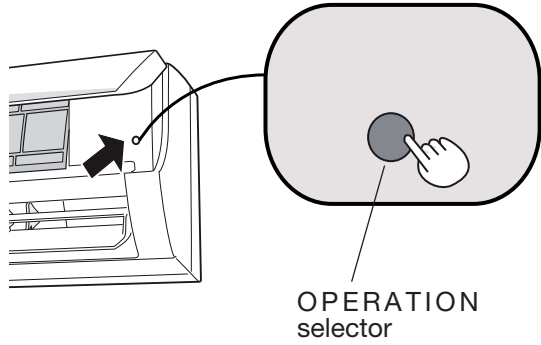

USE WITH WIRED CONTROLLER (OPTIONAL-NOT SUPPLIED)

EN

This wired controller can be combined with different types of indoor units: for this reason some functions may not be available.

However, the selection of any functions not available for a certain type of unit does not affect the correct functioning of the controller itself: simply nothing will happen.

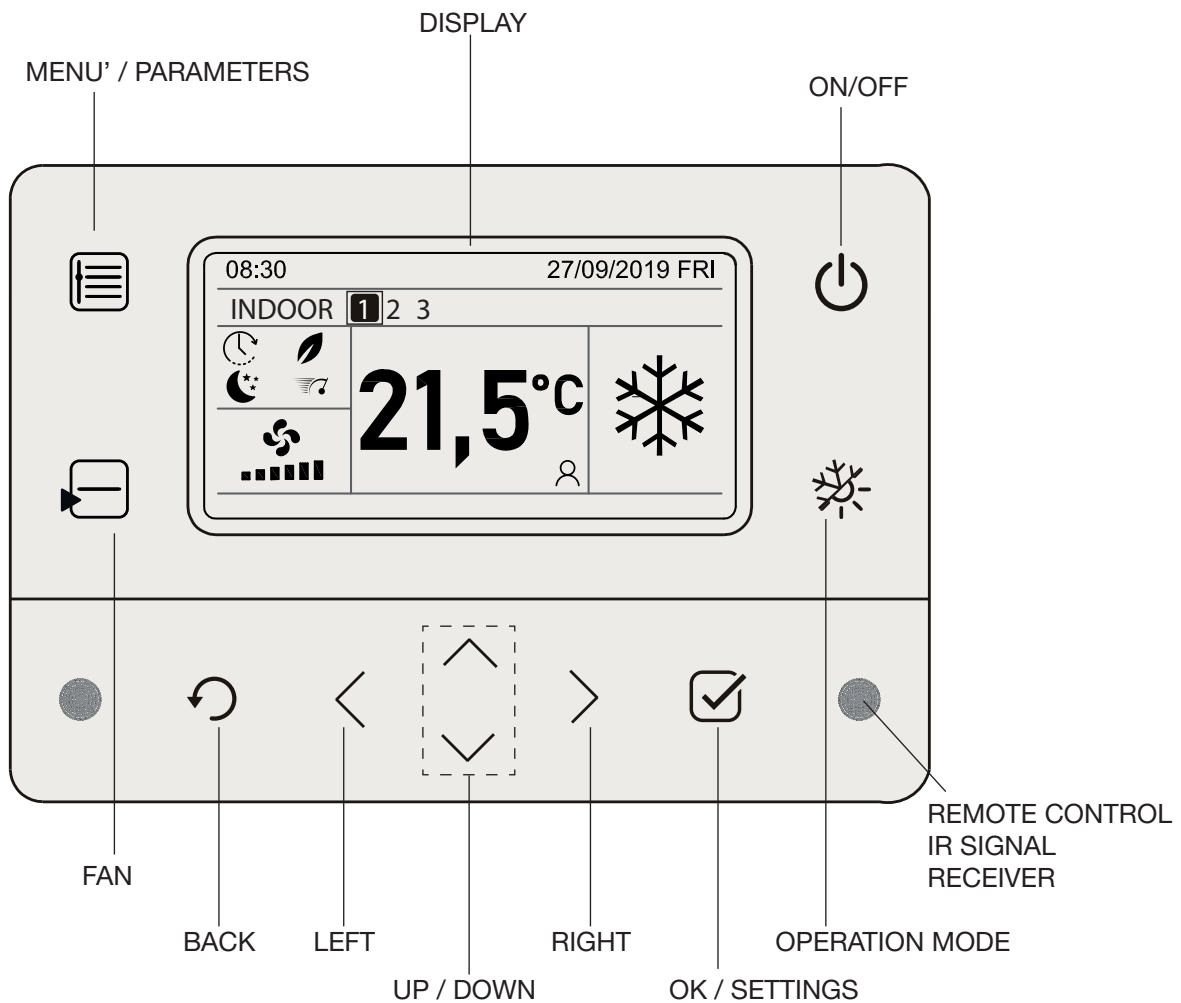

BUTTONS

ON / OFF Button: Push this button to turn ON / OFF the selected unit (square around the icon number of the unit). Press it for 2 seconds to turn OFF all the units simultaneously.

OPERATION MODE Button: Push this button to change the working mode.

FAN Button: Push this button to change the fan speed.

MENU / PARAMETER Button: Push this button to enter the main parameters menu. Press it for 2 seconds to enter the advanced parameters menu (protected by password).

LEFT / RIGHT Buttons: Push these buttons to select indoor units.

UP / DOWN Buttons: Push these buttons to change the setpoint of the selected unit.

BACK Button: Push this button to go back to the previous menu.

OK / SETTINGS Button: Push this button to change the value of the selected parameter (see PARAMETERS MENU).

HOME DISPLAY

Main functions of the wired controller can be set directly on the home display:

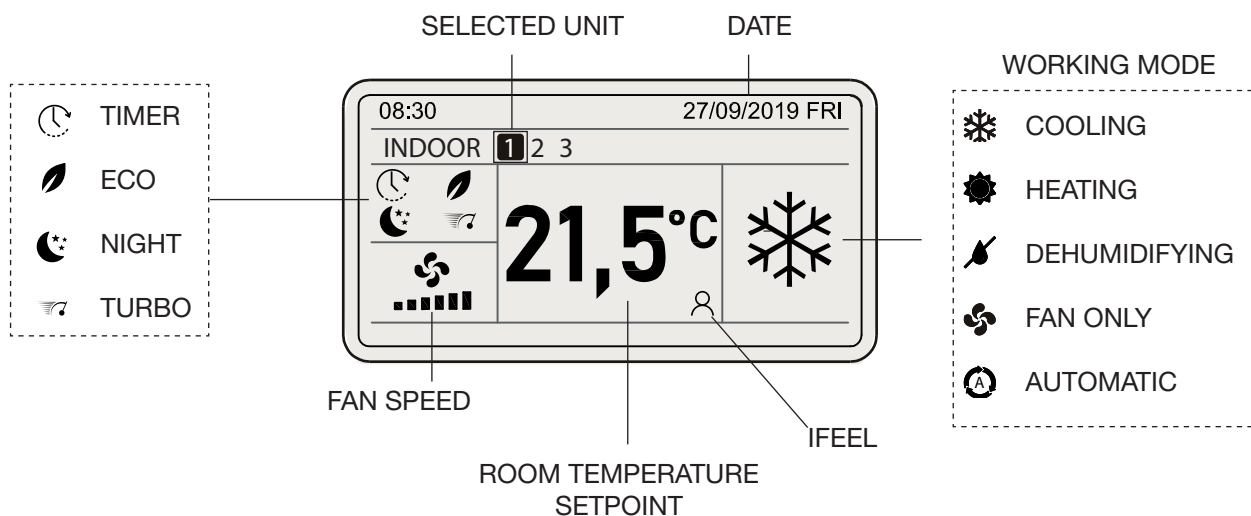

SELECTED UNIT: The box around the unit number indicates the selected unit.

HIGHLIGHTED UNIT: If the unit number icon is highlighted the unit is ON.

WORKING MODE: This symbol shows the working mode of the connected unit.

FAN SPEED: Every time you push the fan button the fan speed changes as follows:

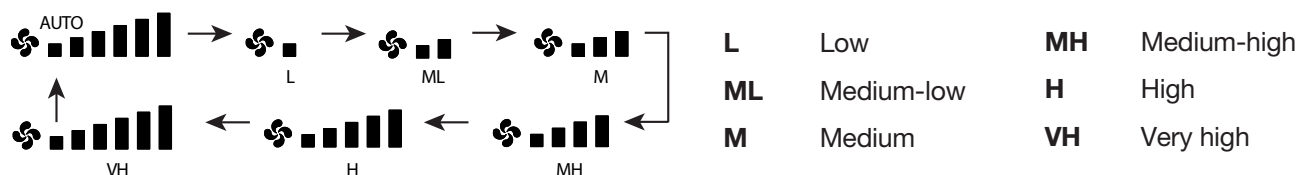

NOTE: When the unit is off, the fan speed icon will not be shown and the unit number icon will not be highlighted.

ROOM / DESIRED TEMPERATURE: The display generally shows the room temperature.

Use the \wedge / \vee buttons to change the value of the desired temperature.

NOTE: If an error is present, in place of the temperature, the text “E xx” will be showed, where xx is the number of the error. (See AUTO-DIAGNOSIS TABLE).

IFEEL: When the display shows this symbol the IFEEL function is active.

The room temperature is detected and checked by the temperature sensor placed inside the wired controller or by IR Remote control sensor if a signal has been received (see section “USE WITH INFRARED REMOTE CONTROL”) and up to 10 minutes from the last signal received.

ATTENTION!

For further details about working modes, see section “REMOTE CONTROL UNIT”.

MAIN PARAMETERS MENU

If the icon is highlighted the parameter is active.
Use the < / > buttons to move between the icons.
Use the OK button to change the value of the selected parameter.

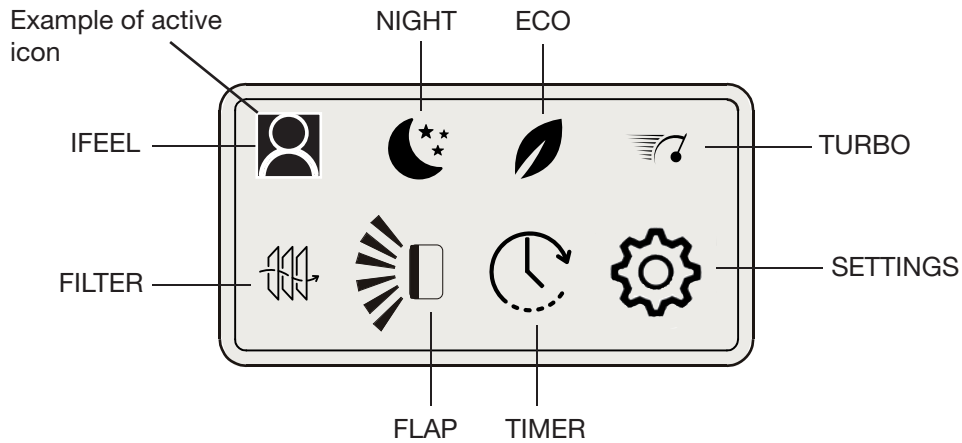

IFEEL - NIGHT - ECO - TURBO - FILTER: use OK button to activate or deactivate the function.

FLAP: Every time you press the OK button the flap position changes as follows:

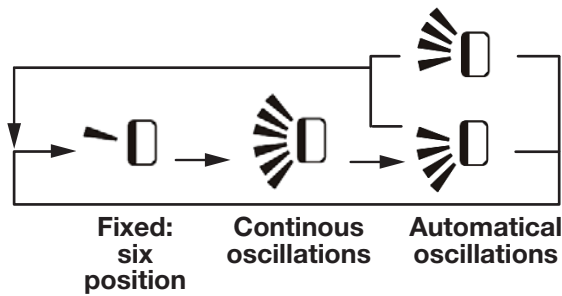

ATTENTION!

For a correct setting of FLAP, please refer to the section "ADJUSTING THE AIR FLOW DIRECTION".

TIMER: Every time you press the OK button you select a type of timer:

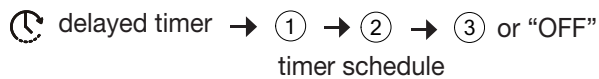

For timer setting see section "SETTING MENU"

SETTING: Pressing the OK button you open the Setting menu.

ATTENTION!

For details about NIGHT, ECO, TURBO, FILTER functions, see section "REMOTE CONTROL UNIT".

SETTINGS MENU

Use the </> buttons to move between the icons.

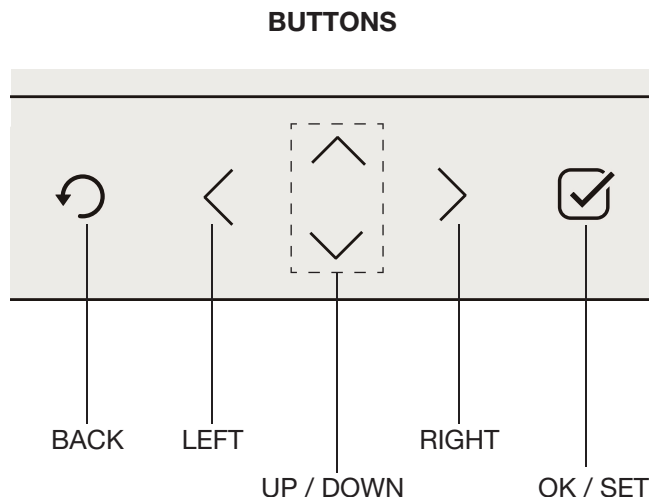
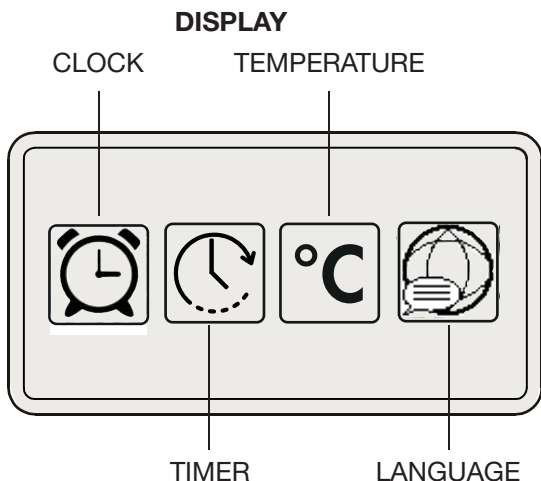

CLOCK:

Select CLOCK icon and press OK to enter the setting menu. The following options will appear:

LEVEL 1	LEVEL 2
CLOCK FORMAT	24h
TIME	15:48
DATE	16/11/2021 TUE

Select the parameter to be modified (**LEVEL 1**) using the buttons UP/DOWN, long press the OK button to change the setting or value, always using the buttons UP/DOWN (**LEVEL 2**).

Then press OK to confirm or BACK to cancel the change.

CLOCK FORMAT

It is possible to change the clock format between 24h or 12h am / pm

TIME

Set the current time, once you have entered LEVEL 2, press OK to move to the minutes' setting.

DATE

Set the current date, once you have entered LEVEL 2, press OK to move to the setting of month and day.

TIMER:

Select TIMER icon and press OK to enter the setting menu. The following options will appear:

LEVEL 1	LEVEL 2
DELAY TIMER min	60
CALENDAR	

Select the parameter to be modified (**LEVEL 1**) using the buttons UP/DOWN, long press the OK button to change the setting or value, always using the buttons UP/DOWN (**LEVEL 2**).

Then press OK to confirm or BACK to cancel the change.

DELAY TIMER

It is possible to set the on or off delay (minutes) when this type of timer is selected.

CALENDAR

Press OK to enter the setting menu. The following options will appear:

LEVEL 1	LEVEL 2			
SCHEDULE	1	DAY	Enabled	LEV. 1
T on	14:30	SUN	OFF	LEV. 2
T off	17:30	MON	ON	
		TUE	OFF	
		WED	ON	
		THU	ON	
		FRI	ON	
		SAT	OFF	

SCHEDULE

Select the number of the Timer program to be set (1, 2 or 3).

T on (ON TIME)

Set the ON time, once you have entered LEVEL 2, press OK to move to the minutes' setting.

T off (OFF TIME)

Set the OFF time, once you have entered LEVEL 2, press OK to move to the minutes' setting.

DAY

Select the day, then press OK to move to the ON or OFF setting.

TEMPERATURE: Choose CELSIUS or FAHRENHEIT pressing OK button.

LANGUAGE: Press OK button to change the language (English, Italian, French, Spanish, German, Portuguese).

ADVANCED PARAMETERS MENU

Press the MENU / PARAMETERS button for 2 seconds to enter the advanced parameters menu, then enter the password. This is the list of parameters:

P1	RESET DEFAULT VALUES	OFF
P6	TLC CHANNEL	0
P8	CIRCUIT ADDRES	A
P9	RH TRESHOLD	50%
P12	ECO MODE %	75%
P13	RAT CORRECTION	0
P14	ANTIFREEZE CORRECTION	0
P15	MODBUS ADDRESS	1
P16	MODBUS BAUD RATE	19200
P17	PARITY MODE	1
P18	FAN SPEED SHIFT	0
	LCD CONTRAST	50
	LCD BRIGHTNESS	90
	UNIT TYPE	
	UNIT SW CODE	
	UNIT SW VERSION	
	PANEL SW VERSION	

Use the ^ / v buttons to move between the parameters.

Once selected the desired parameter, press the OK button for 2 seconds and then it is possible to change the value of the parameter still using the ^ / v buttons.

Press OK to confirm.

NOTE: This modification is not possible for the last four parameters that are just read values.



WARNING

- Maintenance operations must be carried out by specially trained personnel.
- For safety, be sure to turn the air conditioner off and also to disconnect the power before cleaning.
- Do not pour water on the indoor unit to clean it. This will damage the internal components and cause an electric shock hazard.

CASING AND GRILLE (INDOOR UNIT)

Clean the casing and grille of the indoor unit with a vacuum cleaner brush, or wipe them with a clean, soft cloth. If these parts are stained, use a clean cloth moistened with a mild liquid detergent. When cleaning the grille, be careful not to force the vanes out of place.



CAUTION

- Never use solvents, or harsh chemicals when cleaning the indoor unit. Do not wipe the plastic casing using very hot water.
- Some metal edges and the vanes are sharp and may cause injury if handled improperly; be especially careful when you clean these parts.
- The internal coil and other components of the outdoor unit must be cleaned every year. Consult your dealer or service centre.

AIR FILTER

The filter behind the front panel should be checked and cleaned at least once every three months or more frequently in case of excessive dust in the room.

Do not use fire or air dryer to dry the filter, to avoid deformation or fire hazard.

HOW TO REMOVE THE FILTER

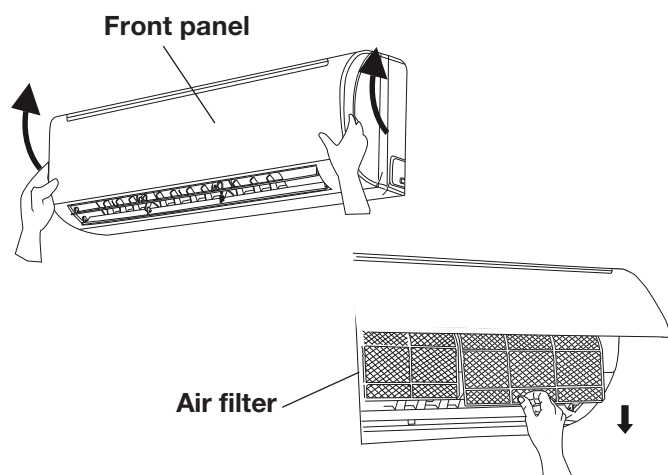

1. Grasp both ends of the front panel and pull it towards you and up.
2. Push the filter up slightly, and then pull it down. Clean the air filter.

HOW TO REPLACE THE FILTER

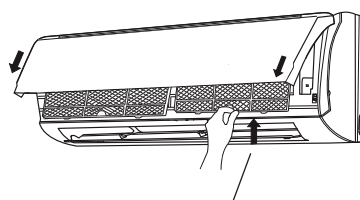

Insert into the groove on the unit

1. With the «FRONT» mark facing you, slide the filter up into the unit and insert it in its place.
2. After installing the filter, close the front panel.

FILTER CLEANING

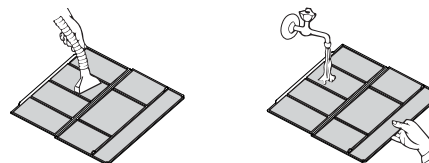

Use a vacuum cleaner to remove light dust. If there is sticky dust on the filter, wash the filter in lukewarm, soapy water, rinse it in clean water, and dry it.

TIPS FOR ENERGY SAVING

DO NOT:

- Block the air intake and outlet of the unit. If they are obstructed, the unit will not work well, and may be damaged.
- Let direct sunlight into the room. Use sunshades, blind or curtain.

DO:

- Always try to keep the air filter clean. A clogged filter will impair the performance of the unit.
- To prevent conditioned air from escaping, keep windows, doors and any other openings closed.

TROUBLESHOOTING



WARNING

- In case abnormal operation of the air conditioner is noticed, try to restore normal operation turning-off electric supply for about 3 minutes, through the main switch or the wall plug, then start again the air conditioner.

If your air conditioner does not work properly, first check the following points before requesting service. If it still does not work properly, contact your dealer or service centre.

Trouble: the air conditioner does not run at all.

Possible cause:

1. Power failure.
2. Leakage breaker tripped.
3. Operation button is OFF.
4. Batteries in remote control unit have run down.

Remedy:

1. Restore power.
2. Contact service centre.
3. Press the button again.
4. Replace batteries.

Trouble: Poor cooling or heating performance.

Possible cause:

1. Dirty or clogged air filters.
2. Heat source or many people in room.
3. Doors and/or windows are open.
4. Obstacle near air intake or air discharge port.
5. The set temperature on the remote control unit is too high.
6. Outdoor temperature is too low (heat pump version).
7. Defrosting system does not work (heat pump version).

Remedy:

1. Clean air filters to improve airflow.
2. Eliminate heat source if possible.
3. Shut them to keep the heat or cold out.
4. Remove it to ensure good airflow.
5. Set the right temperature on the remote control unit.
6. Try to use a back-up heater.
7. Consult your dealer.

Trouble: Clicking sound is heard from the air conditioner.

Possible cause:

1. During operation, any plastic parts may expand or shrink due to a sudden temperature change. In this event, a clicking sound may occur.

Remedy:

1. This is normal, and the sound will disappear when an even temperature is settled.

Trouble: "Water flowing" noise.

Possible cause:

1. Was the air conditioner just turned on or off?

Remedy:

1. Noise is produced by the refrigerant flowing inside the unit (normal phenomenon).

AUTO-DIAGNOSIS TABLE

ERROR	POSSIBLE CAUSE	SYSTEM BEHAVIOUR	SOLUTION
E0	<p>Unit has not been addressed correctly.</p> <hr/> <p>Operating mode selected is not compatible with the system (ex. heating mode has been selected, when the system was in cooling mode, or vice versa).</p>	<p>Fan is stopped and flap is closed. The system restarts automatically as soon as the unit is addressed correctly.</p> <hr/> <p>Fan is stopped and flap is closed. The system restarts automatically as soon as a correct operating mode is selected.</p>	<p>Set the outdoor/indoor unit refrigerant circuit address (see Installation Instructions)</p> <hr/> <p>Select an available or compatible mode with the other units of the system.</p>
E1	<p>Error on the outdoor unit.</p>	<p>Fan is stopped and flap is closed. The system restarts automatically as soon as the problem on the outdoor unit is solved.</p>	<p>Check the error code using the appropriate LEDs on the PCB of the outdoor unit. Follow the indications of the diagnosis for the outdoor unit.</p>

ERROR	POSSIBLE CAUSE	SYSTEM BEHAVIOUR	SOLUTION
E3	Communication error between the outdoor unit and the indoor unit	Fan is stopped and flap is closed after 30 seconds of missing communication. The system restarts automatically as soon as the communication is recovered.	<p>Check that connections between C1 and C2 on outdoor and indoor terminal block are correct (C1 terminals connected together, C2 terminals connected together).</p> <p>Check that a shielded communication cable has been used.</p> <p>Check that the dip-switch SW1 for communication address setting is in the correct position.</p> <p>Check that all earth cables are properly connected to every terminal.</p> <p>Check that the shield of the communication cable is properly connected to every terminal.</p> <p>Check the communication fuse on outdoor and indoor unit.</p> <p>Check that the outdoor unit has power supply and that it is working.</p> <p>Check that all PCBs are powered on.</p> <p>Be sure that power supply has not been connected to the communication terminals.</p> <p>Check that there are no burnt signs on the PCBs, in particular close to communication cables.</p> <p>Check that the fan motor is not damaged and it doesn't create short circuit on the indoor PCB.</p>

ERROR	POSSIBLE CAUSE	SYSTEM BEHAVIOUR	SOLUTION
E4	Defective or not connected indoor coil temperature sensor.	Fan is stopped and flap is closed. The system restarts automatically as soon as the sensor is repaired.	Check that the sensor is properly connected to the PCB as shown in the electrical wiring diagram. Check that the sensor is not damaged and, if necessary, replace it.
E5	Defective or not connected room air temperature/humidity sensor.	Fan is stopped and flap is closed. The system restarts automatically as soon as the sensor is repaired.	Check that the sensor is properly connected to the PCB as shown in the electrical wiring diagram. Check that the sensor is not damaged and, if necessary, replace it.
E6	Fan motor error.	Fan is stopped and flap is closed. The system restarts automatically after some seconds.	Check that the fan motor is properly connected to the PCB as shown in the electrical wiring diagram. Check that the fan motor is not locked. Check that the fan motor is not damaged and, if necessary, replace it.
E8	Combination between outdoor unit and indoor units is not correct.	Fan is stopped and flap is closed.	Check that you have selected, during the installation of the system, a proper combination between outdoor unit and indoor units. Check that none of the indoor units of the system has a communication error. If present, first solve this error.
E99 *	Communication error between indoor unit and wired controller.	Wired controller can not be used.	Check the wires' connection and that the type of communication wire is the one indicated in the installation manual.

NOTE: If the trouble is not solved with the above actions, contact your service centre.

*** Only in case of connection with wired controller.**



INFORMATION FOR CORRECT DISPOSAL OF THE PRODUCT IN ACCORDANCE WITH THE EUROPEAN DIRECTIVE 2012/19/EU

At the end of its working life this equipment must not be disposed of as an household waste. It must be taken to special local community waste collection centres or to a dealer providing this service. Disposing of an electrical and electronic equipment separately avoids possible negative effects on the environment and human health deriving from an inappropriate disposal and enables its components to be recovered and recycled to obtain significant savings in energy and resources. In order to underline the duty to dispose of this equipment separately, the product is marked with a crossed-out dustbin.



INFORMATION FOR CORRECT DISPOSAL OF THE BATTERY IN ACCORDANCE WITH THE EUROPEAN DIRECTIVE 2006/66/EC

Please replace battery when its electricity charge is used up: please do not eliminate this battery together with normal household waste. It must be taken to special local community waste collection centres or to a dealer providing this service. Disposing of a battery separately avoids possible negative effects on the environment and human health deriving from an inappropriate disposal and enables its components to be recovered and recycled to obtain significant savings in energy and resources. In order to underline the duty to dispose of this equipment separately, the battery is marked with a crossed-out dustbin.

argoclima s.p.a.

Via Alfeno Varo, 35 - 25020 Alfianello - BS - Italy

Tel. +39 0331 755111 - Fax +39 0331 755501

www.argoclima.com
