



EN

## WALL-MOUNTED CERAMIC FAN HEATERS

**CHIC SILVER**  
**CHIC WHITE**  
**CHIC BERRY**



**This product is only suitable for well insulated spaces or occasional use.**

## OPERATING INSTRUCTIONS

Read the instructions carefully before operating the appliance or carrying out maintenance operations.

Observe all the safety instructions; failure to observe the instructions may lead to accidents and/or damage. Store these instructions.

## GENERAL SAFETY INFORMATION

- Use this fan heater only as outlined in this manual. Any other use not recommended by the manufacturer may cause fire, electric shock or injury to persons.
  - Make sure that the type of mains power complies with the electrical requirements of the fan heater (220-240 V~50 Hz).
  - **This fan heater is designed for wall-installation; it must be mounted 1.8 m above the floor and at least 25 cm from the wall on each side. Do not use it as a floor-standing device.**
  - This appliance can be used by children of at least 8 years of age and by people with reduced physical, sensory or mental abilities, or who lack sufficient experience or the necessary knowledge, provided that they are supervised or have been instructed on how to use the appliance safely and understand the hazards related to its use.
  - Children must not be allowed to play with the appliance.
  - Cleaning and maintenance operations normally carried out by the user must not be performed by unsupervised children.
  - This product is not a toy.
  - Children under the age of 3 must be kept away if not continuously supervised.
  - Children aged between 3 and 8 must only turn the appliance on / off as long as it has been placed or installed in its normal operating position and that they receive surveillance or instructions regarding the safe use of the appliance and understand the dangers.
  - Children between 3 and 8 years of age must not insert the plug, adjust or clean the appliance or carry out maintenance by the user
- WARNING: Certain parts of this product may become very hot and cause burns. Special care should be taken when children and vulnerable people are nearby.**
- To avoid the risk of accidentally resetting the thermal protection, this appliance must not be powered through an external switching device, such as a timer, or connected to a circuit that is switched on and off by the utility.
  - **WARNING: Do not use the fan heater with a controller or any other device that activates the appliance automatically, as there may be a risk of fire if the fan heater is covered or incorrectly positioned.**
  - Do not restrict the air inlet and outlet grilles.
  - The appliance heats up significantly when running and can cause burns. Avoid unprotected contact with the hot surface.

- Keep flammable materials, such as furniture, cushions, blankets, paper, cloths, curtains and similar items at least 1 m away from the front, sides and back of the appliance.
- Disconnect the mains power when the appliance is not in use or during cleaning.
- Avoid using the fan heater in dusty environments or in the presence of flammable vapours (e.g. in workshops or garages).
- Do not place anything on the product; avoid placing wet garments on the fan heater.
- Use the fan heater in a well-ventilated area.
- Avoid placing fingers or foreign objects in the air inlet/outlet grilles, as this may lead to electric shock or fire and may damage the fan heater.
- To prevent the risk of fire, do not block the grilles or tamper with them in any way while the fan heater is in use.
- **Do not use the appliance if the power cable or plug are damaged.** If the power cable is damaged, it must be replaced by the manufacturer or its technical assistance service or in any case by a person with a similar qualification, in order to prevent any risk.
- Do not use the fan heater if it has fallen from a certain height or if it has been damaged in any way. Contact a service centre to check the fan heater or make any necessary electrical or mechanical repairs.
- The most common cause of overheating is the build-up of dust in the appliance. Remove accumulated dust, after taking the plug out, by cleaning the grilles using a vacuum cleaner.
- Do not use any abrasive products to clean the appliance. Clean it using a damp (not wet) cloth rinsed in soapy water. Remove the plug from the socket before performing any maintenance.
- To disconnect the fan heater, turn the switch to OFF and remove the plug from the socket. Pull on the plug only. Do not pull on the cable when turning off the fan heater.
- Do not place any objects on the cable and also avoid bending the cable.
- Using extension leads are not recommended as they may overheat and cause a fire hazard. Never use a single extension lead to operate multiple appliances.
- Do not immerse the power cable, plug or any other part of the appliance in water or other liquids.
- Do not touch the plug with wet hands.
- Do not place the fan heater above or near another heat source.

## **WARNING: AVOID COVERING THE FAN HEATER TO PREVENT IT FROM OVERHEATING.**

The symbol below signals this warning:



- The fan heater may cause the risk of fire if, while operating, it is covered or comes into contact with **flammable** material including curtains, drapery, blankets, etc. **KEEP THE FAN HEATER AWAY FROM THESE MATERIALS.**
- Do not connect the fan heater to the power supply until it has been correctly assembled or positioned.
- Do not run the cable under carpets. Do not cover the cable with blankets, carpets or similar materials. Place the cable away from busy areas and where it cannot accidentally be pulled out.
- Do not operate the fan heater in close proximity to bathtubs, showers, washbasins or pools.
- Do not use in bathrooms.
- Do not position the fan heater beneath a power socket.
- Do not operate the appliance outdoors.
- Upon initial start-up, the fan heater may emit a slight, harmless smell. This smell is a normal effect of the initial heating up of the internal heating elements, and should not recur subsequently.

### **WARNING:**

**THE ON/OFF SWITCH IS NOT THE ONLY METHOD OF DISCONNECTING THE MAINS POWER.**

**ALWAYS UNPLUG THE APPLIANCE DURING MAINTENANCE OPERATIONS, WHEN MOVING IT OR WHILE IT IS NOT IN USE.**

- A fan heater contains parts that generate electrical arcs and sparks. It must not be used in potentially dangerous areas such as those subject to the risk of fire or explosion, or areas filled with chemical substances or humidity.
- Always unplug the appliance when it is not in use.
- Turn the appliance off if unattended, in order to prevent accidents.
- In the event of any anomalies (abnormal noise or a strange smell), immediately turn off the appliance; do not attempt to repair it but take it to your local service centre.

## DESCRIPTION OF PARTS

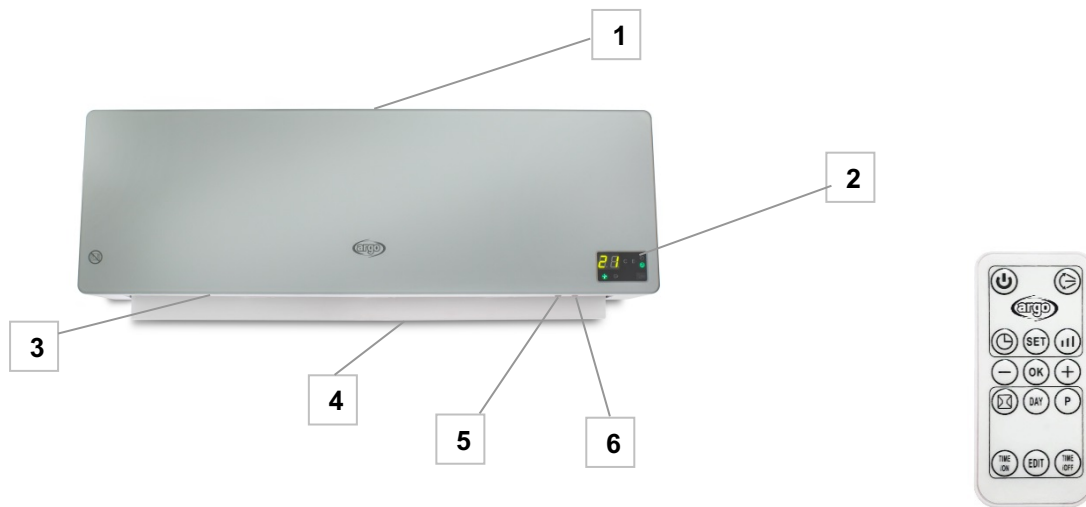

1. Air suction grille
2. LED display
3. Air output grille
4. Horizontal flap
5. TIMER button
6. Function selection F button

7. Remote control

## HOW TO INSTALL THE FAN HEATER

The fan heater must be installed on the wall before use. Do not try to use it without installation. The installation sequence is listed below:

1. Select a space for installing the appliance (figure 1).
2. Drill two holes on the wall that are suitably sized for inserting the  $\varnothing 8$  mm Fischer screw plugs. (figure 2) –  $D=575$  mm

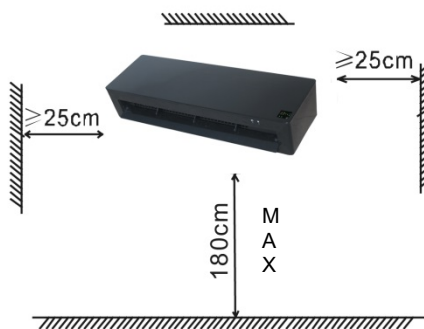

Figure 1

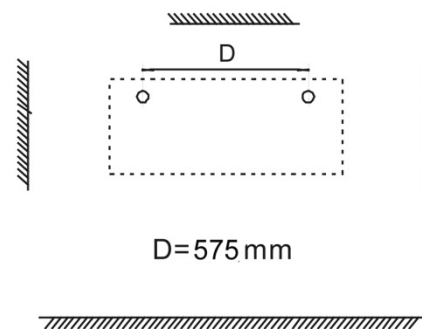

Figure 2

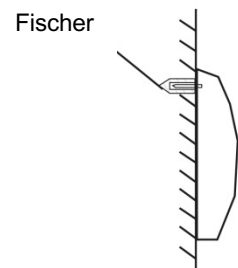
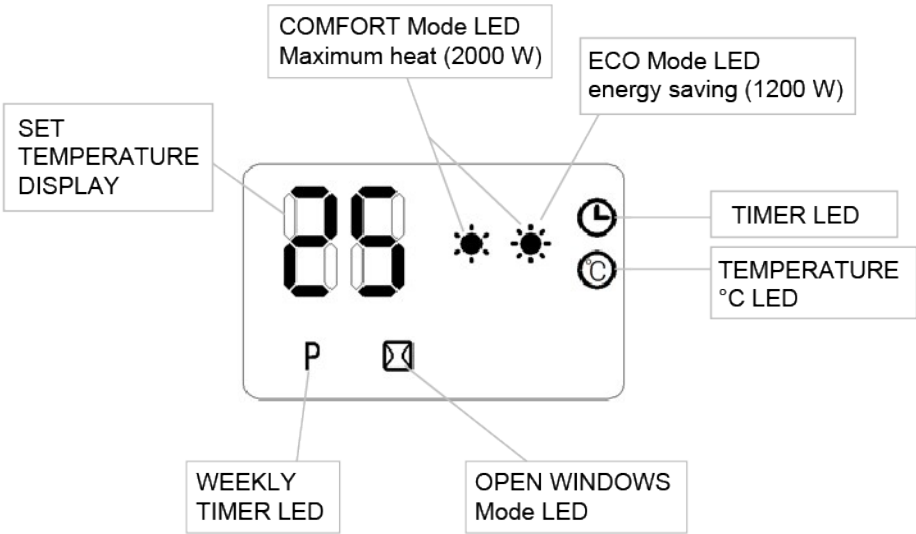
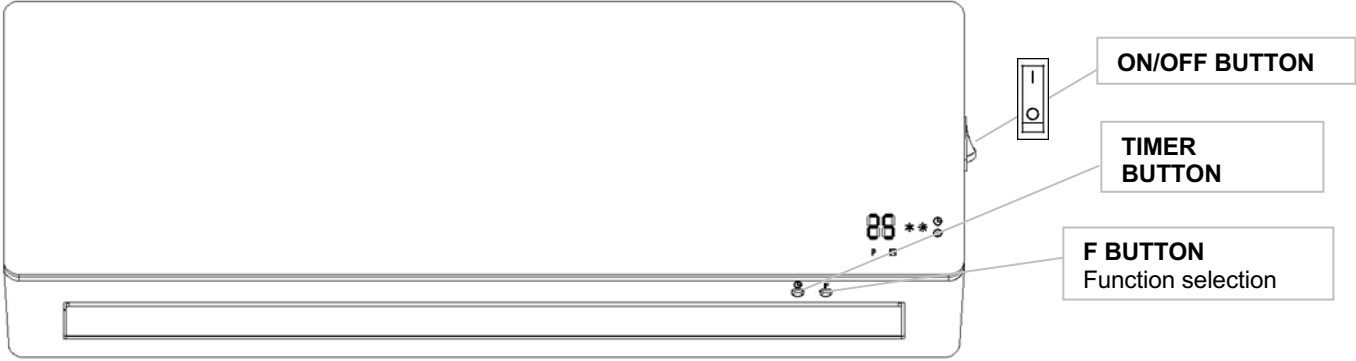

Figure 3

3. Insert the Fischer screw plugs into the holes and tighten the screws provided.  
**NOTE:** Tighten the screws securely. Do not insert the screws into the Fischer plugs entirely - leave around 10 mm free.
4. Mount the appliance on the wall (figure 3).  
Ensure that the holes on the rear of the appliance are directed towards the two screws, push the fan heater backwards onto the wall then downwards until it lies in a stable position.

# CONTROL PANEL AND LED DISPLAY ON THE APPLIANCE



## REMOTE CONTROL

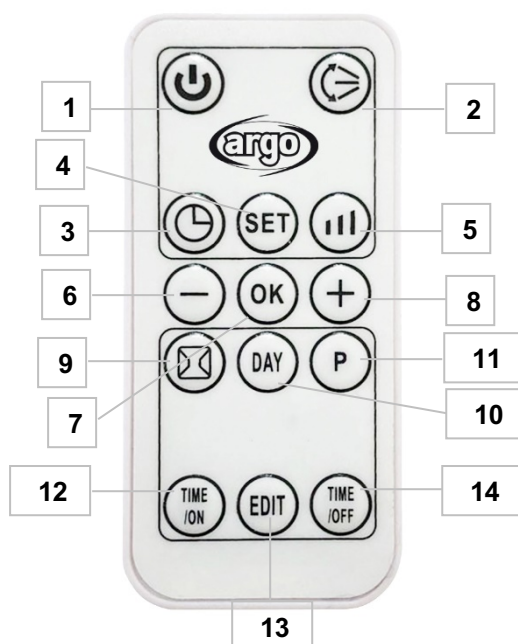

1. ON/OFF button - switching on/off from stand-by mode
2. SWING button - flap swivel setting
3. TIMER button - setting daily timer ON/OFF (1-12h)
4. SET button - set
5. MODE button - fan mode setting cold, ECO, COMFORT
6. Button - temperature regulation
7. OK button - confirm weekly programmes
8. + Button temperature regulation
9. Open window function activation button
10. DAY button - day selection for weekly timer
11. P button - weekly Timer activation
12. Time ON button – weekly timer switch ON setting
13. EDIT button - weekly timer operation period setting
14. Time OFF button - weekly timer switch OFF setting

Use Lithium/Manganese button cells, model no. CR2025 -3 V, conforming to Battery Directive no. 2006/66/EC and modification by Dir.no 2013/56/EU (not supplied).

### HOW TO INSERT / REMOVE THE REMOTE CONTROL BATTERIES (refer to the diagram below)

Open the battery cover at the back of the remote control (press the back and pull the flap).

Insert the battery into the slot, making sure you respect the polarities.

Put the cover back onto the remote control.

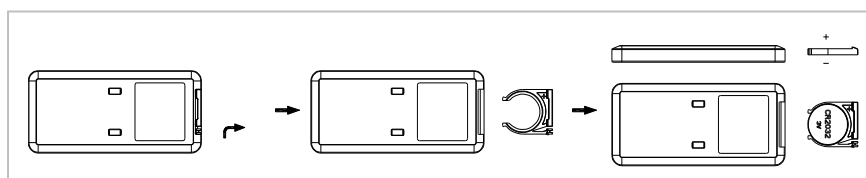

## WARNINGS FOR BATTERIES

Batteries must not be exposed to heat sources such as fire, sun or similar sources;

Remove the batteries if they start to heat up or you know you will not use the appliance for a long time

- the batteries must be installed correctly in the appropriate battery compartment;

- when you remove the batteries because they are damaged or at the end of their life, dispose of them according to the national regulations in force and indicated below.

- In case of battery fluid leak, remove all batteries, avoiding the leaked liquid from coming into contact with skin or clothes.

If liquid from the battery comes into contact with skin or clothing, wash the skin with water immediately. Before inserting new batteries, carefully clean the battery compartment with a paper towel, or follow the battery manufacturer's recommendations for cleaning.

● Warning Danger of explosion if battery is replaced with an incorrect type. Use and replace only batteries with the same size and type

Improper use of batteries can cause liquid leakage, overheating or explosion.

This liquid is corrosive and can be toxic. It can cause skin and eye burns, and is harmful to ingest.

To reduce the risk of injury:

● Keep batteries out of the reach of children.

● Do not heat, open, puncture, cut or throw batteries into fire.

● Do not mix old and new batteries or batteries of different types

● Do not leave metal objects that can come into contact with the battery terminals and therefore can heat up and / or cause burns.





### INFORMATION FOR THE CORRECT DISPOSAL OF BATTERIES IN ACCORDANCE WITH EUROPEAN DIRECTIVE 2006/66/EC AND CHANGES INTRODUCED BY DIRECTIVE 2013/56 / EU

Replace batteries when they are depleted. At the end of their life, batteries must be disposed of separately from unsorted waste. They must be taken to designated recycling centres or returned to a retailer providing this service. Separate disposal of batteries prevents potential negative effects on the environment and human health due to inadequate disposal, and also allows their constituent materials to be recovered and recycled, resulting in significant savings in terms of energy and resources. In order to highlight the obligation regarding separate disposal, the battery carries the crossed-out dustbin symbol. Illegal disposal of the product by the user may lead to administrative sanctions being applied as per current regulations.

## HOW TO USE THE FAN HEATER

Connect the power cable to a suitable electric socket (220-240V~50Hz), as indicated in the data plate.

### SWITCHING THE FAN HEATER ON

Press the  button on the appliance to switch the fan heater to stand-by mode. Press the  on the remote control to switch the appliance ON.

### AUTOMATIC FLAP SWIVEL

Press the  button on the control panel or  on the remote control to select the operating mode.

### ACTIVATION OF SUMMER VENTILATION (FAN) AND HEATING (ECO – COMFORT) MODES

Press the  button on the control panel or  on the remote control to select the operating mode.

In stand-by mode the LED display is the following:



In Summer ventilation (FAN) mode the LED display is the following





In ECO heating mode (1200 W) the LED display is the following:

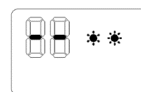

In COMFORT heating mode (2000 W) the LED display is the following:



To return to stand-by mode press the buttons  or  again respectively on the appliance and on the remote control. The default set temperature is 23°C.

The fan heater switches off about 30 seconds after the stand-by mode has been activated.



## TEMPERATURE REGULATION

The temperature can only be set via the remote control. Press the + or – buttons to regulate the desired temperature (from

10°C to 49°C). If you set the temperature to 25°C the “°C” LED comes on as shown in the figure:





Press  to cancel the temperature setting.

## ECO SMART FUNCTION

The fan heater operates at maximum power (COMFORT mode) when the set temperature is at least 4°C higher than the room temperature; if the set temperature is 0-2°C higher than the room temperature, the fan heater operates at medium power (ECO mode), if the room temperature is higher than the set temperature the fan heater switches off and starts operating again when the room temperature drops 2°C below the set temperature.

## ON/OFF DAILY TIMER SETTING

In stand-by mode, press the  button to set the switch-on timer. The switch-on timer can be set from 1 to 12 hours, by pressing on the same button to move on in intervals of 1 h: the default set temperature when it switches on is 23°C.

When the appliance is operating, to set the switch-off timer press the  button; the switch-off timer can be set from 1 to 12 hours, by pressing on the same button to move on in intervals of 1 h.

## TIME SETTING (Only from the remote control)

Press the SET button to show the time on the display; press the + or – buttons to set the current hour (00-24); press the SET button again to set the minutes (00-59); press the SET button again to set the day of the week – if you press + or – the display will show the following abbreviations: d1, d2, d3,... which correspond respectively to Monday, Tuesday, Wednesday etc.; once you have selected the current day press OK to confirm.

## SETTING THE WEEKLY TIMER (only via the remote control)

The unit must be turned on for programming.

After having set the time and day of the week, press P to enter the weekly timer setting,

1. Press DAY to set the switch-on day (d1, d2, d3,...),
2. Press EDIT to set the operating periods for the fan heater (P1, P2,... P6)
3. Press TIME/ON to set the switch-on time (00-23)
4. Press TIME/OFF to set the switch-off time (00-23)
5. Press the + or – buttons to set the desired temperature
6. Press OK to confirm the settings

To set any other subsequent operating times, (max 6) repeat the procedure from point 2 to point 6.

Repeat the procedure from point 1 to set the other days of the week.

After completing the weekly timer setting, press the buttons DAY EDIT TIME/ON and TIME/OFF to check the settings for each day.

All settings are deleted when the fan heater is switched off using this switch 

## “OPEN WINDOW” FUNCTION SETTING

When the appliance is operating, press the  button on the remote control to activate the open window

function; the  LED appears on the display, as shown in the figure:



Press the + or – buttons to set the temperature. When this function is active, if the room temperature drops by 5-10°C in less than 10 minutes, the fan heater stops operating and switches to stand-by mode. Press  to restart the appliance.

If both the *weekly timer* and *open window* functions are set and, according to the weekly programme, the appliance is off, the window open function will also be inactive. Conversely, when the appliance is operating in line with the weekly programme, the window open function can control the ON/OFF operation of the appliance.

## OVERHEATING SAFETY DEVICE

In the event of overheating, the protection system of the appliance will automatically disable the heating elements and the motor, thus causing the fan heater to stop working.

In this case:

- turn the fan heater off;
- remove the causes of the overheating (e.g. obstacles in front of the air input/output grilles, dust build-up inside the appliance, etc.);
- leave the appliance to cool down for 15-20 minutes;
- Contact an Authorised Service Centre.

## MAINTENANCE AND STORAGE

**CAUTION: ALWAYS UNPLUG THE APPLIANCE BEFORE CLEANING OR PERFORMING ANY MAINTENANCE.**

**IMPORTANT: DO NOT SUBMERGE THE FAN HEATER IN WATER.**

### **Cleaning the outside surface of the appliance**

Switch off the appliance and unplug it before cleaning or moving the appliance.

Use a soft cloth to remove any dust from the product.

If this is not enough, use a soft cloth dampened with water and neutral detergent at a temperature below 50 °C. Leave the appliance to dry thoroughly before using it again.

Do not use corrosive detergents or solvents such as petrol. Do not wash the appliance with water. When cleaning the appliance, do not use oils, chemical substances or other items that may damage the surface.

Use a vacuum cleaner to remove dust from the air inlet/outlet grilles.

### **STORAGE**

If the appliance is not used for prolonged periods, it must be stored together with this manual in its original packaging, in a cool and dry place.





**INFORMATION ON THE CORRECT DISPOSAL OF THE PRODUCT pursuant to Art. 26 of (Italian) Legislative Decree no. 49 of 14/03/14, "IMPLEMENTATION OF DIRECTIVE 2012/19/EU ON WASTE ELECTRICAL AND ELECTRONIC EQUIPMENT"**

At the end of its useful life, this appliance must not be disposed of together with household waste. We call your attention to the crucial role played by the consumer in the reuse, recycling and other forms of recovery of such waste.

The dismantled appliance, with its components collected separately, must be delivered to the local waste disposal facility or returned to the dealer free of charge when purchasing a new equivalent appliance.

Sorted disposal of electric and electronic equipment prevents potentially negative consequences on the environment and human health due to improper waste disposal, and also allows the constituent materials to be recovered and recycled, with significant savings in terms of energy and resources.

In order to highlight the obligation regarding separate disposal of these devices, the appliance carries the crossed-out wheeled bin symbol.



improve your life

[www.argoclima.com](http://www.argoclima.com)