



APOLLO

OPERATING INSTRUCTIONS **EN**

ISTRUZIONI D'USO **IT**

MODE D'EMPLOI **FR**

BEDIENUNGS-ANLEITUNG **DE**

INSTRUCCIONES DE USO **ES**

MANUAL DE INSTRUÇÕES **PT**

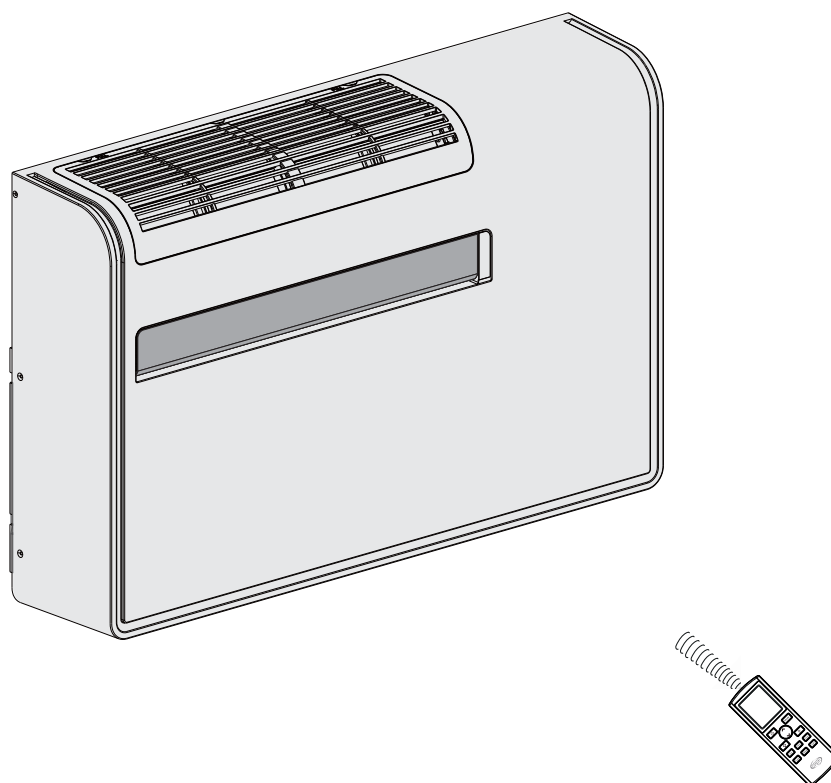

Air conditioner without outdoor unit

Climatizzatore senza unità esterna

Climatiseur sans unité extérieure

Klimagerät ohne Ausseneinheit

Acondicionador de aire sin unidad exterior

Ar condicionado sem unidade externa

CONTENTS

EN

SAFETY INSTRUCTIONS	2
SIGNALING LEDs	3
USING THE REMOTE CONTROL UNIT	4
REMOTE CONTROL UNIT	5
COOLING	6
HEATING (IF AVAILABLE)	6
AUTOMATIC OPERATION	6
DEHUMIDIFYING (DRY)	6
FAN ONLY	6
ADJUSTING THE FAN SPEED	7
SPLEEP MODE	7
TURBO MODE	7
ECO FUNCTION	7
SETTING THE TIMER	8
ADJUSTING THE AIR FLOW DIRECTION	8
OPERATION WITHOUT THE REMOTE CONTROL UNIT	8
TIPS FOR ENERGY SAVING	9
TROUBLESHOOTING	9
HOW TO DISCHARGE THE CONDENSATE WATER	13
CARE AND CLEANING	13
APP DOWNLOAD AND SETTING UP APOLLO IN Wi-Fi MODE	14
Wi-Fi GUIDE (English / Italian)	16

SAFETY INSTRUCTIONS



• Read this booklet carefully before using this air conditioner. If you still have any difficulties or problems, consult your dealer for help.

- This air conditioner is designed to give you comfortable room conditions for domestic use. As far as industrial and professional activities are concerned, Argoclima declines all responsibility for any unsuitability of the appliance depending on its characteristics and the purposes it should be responsible for.



WARNING

- Never use or store gasoline or other flammable vapour or liquid near the air conditioner. It is very dangerous. **Moreover, never install electrical equipment, which is not protected with IPX1 protection (protection against vertical water drop), under the unit.**
- The manufacturer assumes no responsibilities if the safety regulations or local codes are not observed.



CAUTION

- Never use neither the power main switch or the power plug to start or stop the air conditioner. **Always use the ON/OFF button.**
- Do not stick anything into the air outlet of the air conditioner. This is dangerous because the fan is rotating at high speed.
- Do not let children play with the air conditioner.
- Do not cool the room too much if babies or invalids are present.
- Clean the unit only with neutral detergents and as described in the appropriate paragraph.
- Do not place objects on the unit.
- Do not lean or sit on the unit.
- Do not pour liquids on the unit.
- Clean the air filter regularly as described in the appropriate paragraph.

- This air conditioner can be used by children aged from 8 years and above and persons with reduced physical, sensory or mental capabilities or lack of experience and knowledge if they have been given supervision or instruction concerning use of the air conditioner in a safe way and understand the hazards involved.
- Cleaning and maintenance shall not be made by children without supervision.
- For safety, be sure to turn the air conditioner off and also to disconnect the power before cleaning. In case you should remove it, discharge the eventual condensate water inside the bottom plate.

SIGNALING LEDs

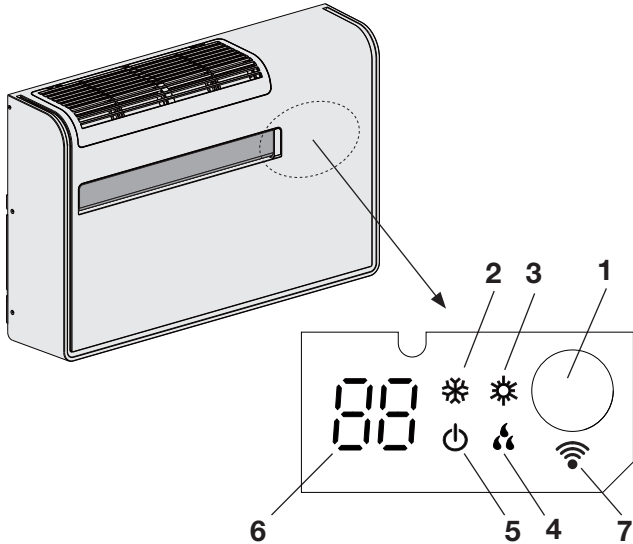

1. **Receiver** : it receives signals transmitted from the remote control.
2. **COOLING LED**: This LED lights up when the air conditioner is operating in cooling mode.
3. **HEATING LED**: This LED lights up when the air conditioner is operating in heating mode (if available).
4. **DEHUMIDIFICATION LED**: This LED lights up when the air conditioner is operating in dehumidification mode.
5. **STANDBY LED**: This LED lights up when you switch off the air conditioner with the remote control and it indicates also the Wi-Fi status during unit's operation.
6. **DIGITAL DISPLAY**: it can display information such as set temperature, ambient temperature, coil temperature, status, fault code, etc.
7. **Wi-Fi**: This LED lights up when the air conditioner is operating in Wi-Fi mode.



WARNING

The OFF position does not disconnect the power. Use the main power switch to turn off power completely.

NOTES

- It is possible to set the air conditioner in order to switch OFF all LEDs, even during operation, by pressing the LIGHT button on the remote control unit.
If the symbol  on remote control display is on, the air conditioner display will be on; if the symbol is off, the air conditioner display will be off.
- In case of troubleshooting the air conditioner diagnostic system activates the lamps accordingly, even if they are set to OFF. See paragraph TROUBLESHOOTING for further details.

USING THE REMOTE CONTROL UNIT

EN

HOW TO INSTALL BATTERIES

- Remove the lid in the rear part of the remote control unit: gently press it with your finger, pushing it out in the direction of the arrow.
- Insert two AAA alkaline batteries of 1,5 V-DC making sure that point in the direction marked in the battery compartment.
Remote controller is now ready for operation.

HOW TO REMOVE BATTERIES

- Remove the lid.
- Press the battery toward the negative end and lift it out by its positive end.
- Remove the other battery in the same way.

NOTES

- The batteries last about six months. Depending on how much you use the remote control unit. Remove the batteries if you do not use the remote control unit for more than one month. Replace the batteries when the remote control unit lamp fails to light, or when the air conditioner does not receive the remote control unit signals.
- The batteries of the remote control contain polluted substances, exhausted batteries must be disposed according to the laws in force.

- If there are curtains, doors or other objects that block the signal from the remote control to the air conditioner, the air conditioner will not be controlled by the remote control.
- Beware of any liquid flowing into the remote control, do not expose the remote control to direct sunlight, or place it in extreme heat.
- If other electronic devices affect the remote control, please remove them.
- You should replace the new battery at the same time, do not use the old battery or different types of batteries, otherwise it will cause the remote control malfunction.
- If the reset occurs when the remote control button is pressed, it indicates that the battery is low. Please replace the battery with a new one.

OPERATION WITH THE REMOTE CONTROL UNIT

When using the remote control unit, always point the remote control unit directly at the air conditioner receiver.

HOW TO TURN ON OR OFF THE AIR CONDITIONER

Press the ON/OFF button on the remote control unit to turn the air conditioner on or off. The standby LED will switch off, indicating the unit is in operation and vice versa.

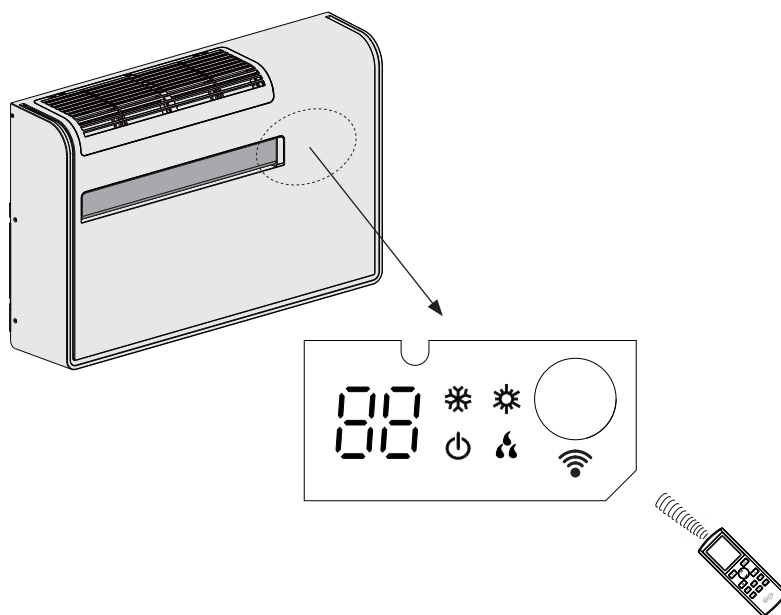

REMOTE CONTROL UNIT

Operation mode

- Automatic
- Cooling
- Dehumidification
- Fan
- Heating

Lock/unlock

Sleep mode

Temperature symbol

(set temp) (indoor temp) (outdoor temp) *

* Not real, it is always indoor temperature

DISPLAY

Fan speed

Displayed when transmitting data

Temperature indication

Timer

Flap

ON/OFF BUTTON

Press the ON/OFF button, in standby mode, to turn on the air conditioner. Press the ON/OFF button, when the power is on, to turn off the air conditioner.

SETTING BUTTONS

FOR TEMPERATURE

- (cooler)
Press this button to decrease the set temperature.

+ (warmer)
Press this button to increase the set temperature.

USE THESE BUTTONS ALSO FOR TIMER SETTING

LOCK/UNLOCK: press ^ and v at the same time to lock/unlock the buttons (symbol)

FAN BUTTON (fan speed)

AUTO Fan speed is automatically selected by the microcomputer.

FAN Low speed.

FAN Medium speed.

FAN High speed.

ECO BUTTON

Press this button in order to select the ECO function (energy saving) during cooling mode.

TURBO BUTTON

Press this button in order to select the TURBO function during cooling mode (super cooling operation) or heating mode (super heating operation).

SLEEP BUTTON

Press this button in order to select the SLEEP mode.

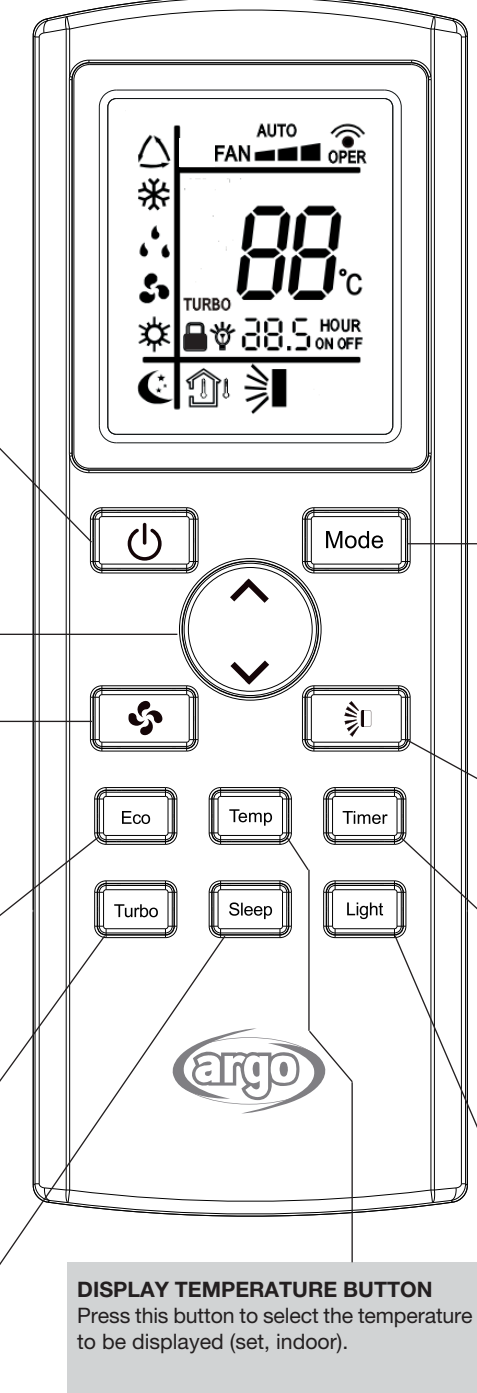

MODE SELECTOR BUTTON

Press this button to modify the air conditioner mode.

Automatic

When this setting is selected, the air conditioner calculates the difference between the thermostat setting and the room temperature and automatically switches to the "cool" or "heat" mode.

Cooling

The air conditioner makes the room cooler.

Dry

The air conditioner reduces the humidity in the room.

Fan

The air conditioner works only as a circulation fan.

Heating (if available)

The air conditioner makes the room warmer.

FLAP BUTTON

Press this button in order to switch on or off the flap swing function.

TIMER BUTTON

Press this button to select the start or stop control of timer function. Use - or + buttons to adjust the set time value (range 0,5-24)

DISPLAY TEMPERATURE BUTTON

Press this button to select the temperature to be displayed (set, indoor).

LIGHT BUTTON

Press this button in order to switch on or off the unit's display.

COOLING

NOTE

Verify that the unit is connected to the main power.

1. Set the MODE selector to COOLING mode (symbol on the display ❄️).
2. Press the ^ / v buttons (temperature selection) to set the desired temperature (the temperature range is between 30 °C max. and 16 °C min.).



 THE DISPLAY SHOWS THE SELECTED TEMPERATURE.

  IF YOU WANT TO VISUALISE THE ROOM TEMPERATURE, PRESS THE TEMPERATURE BUTTON (HUMIDITY).

3. Press the FAN button to select the fan speed.

NOTES

- During cooling operation, when the outside temperature is very low, frost will appear on the surface of the indoor heat exchanger. When the indoor heat exchanger temperature drops below 0 °C for a continuous period of time, the unit stops running.
- Once the setpoint is reached and even if the air conditioner is turned off, it will continue to run for a few minutes in the breeze to remove the residual water on the evaporator surface.

HEATING (IF AVAILABLE)

1. Set the MODE selector to HEATING mode (symbol on the display ☀️).
2. Press the ^ / v buttons (temperature selection) to set the desired temperature (the temperature range is between 30 °C max. and 16 °C min.).

 THE DISPLAY SHOWS THE SELECTED TEMPERATURE.

  IF YOU WANT TO VISUALISE THE ROOM TEMPERATURE, PRESS THE TEMPERATURE BUTTON (HUMIDITY).

3. Press the FAN  button to select the fan speed.

NOTES

- For a few minutes after the start of heating operation, the indoor fan doesn't start until the indoor heat exchanger coil has warmed up sufficiently. This is because the COLD DRAFT PREVENTION SYSTEM is operating. During this period, the STANDBY lamp remains lit.
- During heating operation, when you switch off the unit the fan goes on running for 10 seconds at low speed in order to blow out residual heat air.

DEFROSTING OF OUTDOOR HEAT EXCHANGER

When the outdoor temperature is low, frost or ice may appear on the heat exchanger coil, reducing the heating performance.

When this happens, a protection function for the heat exchanger defrosting is activated. During this function operation, the indoor fan stops. Heating operation restarts after several minutes. (This interval will vary slightly depending on the room and outdoor temperature).

AUTOMATIC OPERATION

1. With the unit off, set the MODE selector to AUTO mode (symbol  on the display).
The selection of the operation mode (cooling or heating) is carried out automatically by the unit according to the ambient temperature detected when AUTO mode is selected.
2. If the ambient temperature is $\geq 26^{\circ}\text{C}$, selecting AUTO, the unit starts to operate in cooling mode until it reaches 25°C ($\pm 1^{\circ}\text{C}$). The default temperature for cooling (and cannot be changed) is in fact 25°C ; it appears on the unit display, while nothing appears on the remote control display.
3. If the ambient temperature is $\leq 20^{\circ}\text{C}$, selecting AUTO, the unit starts to operate in heating mode until it reaches 22°C ($\pm 1^{\circ}\text{C}$). The default temperature for heating (and cannot be changed) is in fact 20°C ; it appears on the unit display, while nothing appears on the remote control display.
4. If the ambient temperature is between 23° and 25°C ($\pm 1^{\circ}\text{C}$), the unit will operate in fan only mode.

DEHUMIDIFYING (DRY)

1. Set the MODE selector to DEHUMIDIFYING mode (symbol on the display ).
2. Press the ^ / v buttons (temperature selection) to set the desired temperature (the temperature range is between 30 °C max. and 16 °C min.).

 THE DISPLAY SHOWS THE SELECTED TEMPERATURE.

  IF YOU WANT TO VISUALISE THE ROOM TEMPERATURE, PRESS THE TEMPERATURE BUTTON (HUMIDITY).

NOTES

- Use DRY operation when you want to reduce the humidity in the room.
- Once the room temperature reaches the set level, the unit repeats the cycle of turning on and off automatically.
- Dry operation is not possible if the indoor temperature is 16°C or less.
- Once the setpoint is reached and even if the air conditioner is turned off, it will continue to run for a few minutes in the breeze to remove the residual water on the evaporator surface.

FAN ONLY

If you want to make air circulate without any temperature control, press the MODE button until the  fan symbol appears on the display.

ADJUSTING THE FAN SPEED

AUTOMATIC

Simply set the FAN  selector to the **AUTO** position. A microcomputer automatically controls the fan speed when the AUTO mode is selected. When the air conditioner starts operating, in heating or cooling, the fan speed varies according to the thermal load of the room.

NOTE

The automatic speed is not available in FAN ONLY mode.

MANUAL

If you want to manually adjust speed just set the FAN selector as desired.

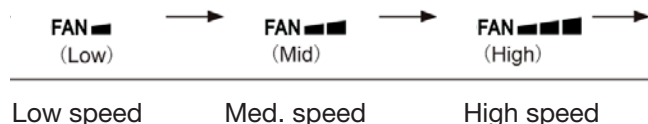

SLEEP MODE

1. Set the MODE selector to COOLING or HEATING mode.
2. Press the SLEEP button.
3. The  mark appears on the display. Press the button again to release the function.

What does the SLEEP mode mean?

When you select the SLEEP mode, the air conditioner automatically limits the power supplied to increase comfort during the night.

How does the SLEEP program work?

Cooling + sleep mode:

The fan speed is reduced by 1 step on the basis of the set fan speed.

After 1 hour of operation, the set temperature is increased by 1 degree.

After 3 hours of operation, the set temperature is increased by 1 degree.

After 8 hours of operation, the program will be automatically canceled, the set temperature will return to the original set temperature and the air conditioner continue to run.

Heating + sleep mode:

The fan speed is reduced by 1 step on the basis of the set fan speed.

After 1 hour of operation, the set temperature is reduced by 1 degree.

After 3 hours of operation, the set temperature is reduced by 2 degrees.

After 8 hours of operation, the program will be automatically canceled, the set temperature will return to the original set temperature and the air conditioner continue to run.

TURBO MODE

You can select TURBO only during cooling or heating mode and not during automatic, dehumidifying (dry) and fan mode. TURBO mode allows to obtain the maximum air conditioner's efficiency, either in cooling or heating mode (heat pump). The user can choose to activate the TURBO mode, using the remote control unit, after having selected cooling or heating mode. Under these conditions the air conditioner will reach its maximum thermal power; it is recommended to use the TURBO mode only if the outdoor temperature is extreme and the selected room temperature is difficult to be reached. On the contrary, if you want to obtain the best performance in efficiency and silentness, TURBO mode is not recommended: let the air conditioner run in normal condition (factory default program).

To activate TURBO mode it is necessary (after having selected the cooling or heating mode) to press the TURBO button, so that the word **TURBO** appears on the remote control's display.

Press the button TURBO again to deactivate this function.

ECO FUNCTION

You can select ECO function (energy saving) only during cooling mode.

Press the Eco button to activate this function: the word **JN** appears on the remote control's display and the word **SE** appears instead of the temperature value.





When this function is activated, the temperature is automatically set to 25°C and the fan speed is changed to automatic speed. The temperature setting and the fan speed setting are no more valid.

Press the Eco button again to deactivate this function.

SETTING THE TIMER

EN







A) HOW TO SET THE ON TIMER

1. In the standby state, press the TIMER button once to enter the timed power-on setting state: the symbol  is blinking.
2. Press the  button (or  button) to adjust the set time value (range 0.5-24 hours), each time you press the + button (or -Key), the time value increases (or decreases) by 0.5 hours.
After adjusting the time value, press the timer button again to confirm and enter the timed state: the symbol  lights. You can see on the display the remaining time of the power on.

HOUR
ON



B) HOW TO SET THE OFF TIMER

1. In the power-on state, press the timer button once to enter the timer shutdown setting state: the symbol  is blinking.
2. Press the  key (or  key) to adjust the set time value (range 0.5-24 hours). Each time you press the  key (or  key), the time value increases (or decreases) by 0.5 hours.
After adjusting the time value, press the timer button again to confirm and enter the timed shutdown state: the symbol  lights. You can see on the display the remaining time of shutdown.

HOUR
OFF

ADJUSTING THE AIR FLOW DIRECTION

Make sure that the remote control unit has been turned on. Press the button  (FLAP) to select the sweep function.



CAUTION

Do not move the flap with your hands when the air conditioner is running.



Sweep function

The flap starts moving up and down to deliver air over the sweep range.

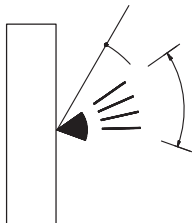

NOTES

- The flap automatically closes when the unit is off.
- During the heating operation, the fan speed will be very low and the flap will be in the horizontal position until the air being blown out of the unit begins to warm. Once the air warms up, the flap position and fan speed change to the settings specified with the remote control.



CAUTION

- Use the FLAP button on the remote control to adjust the position of the flap. If you move the flap by hand, the factual flap position and the flap position on the remote control may no longer match. If this should happen, shut off the unit, wait for the flap to close, and then turn on the unit again; the flap position will now be normal again.

OPERATION WITHOUT THE REMOTE CONTROL UNIT

If you have lost the remote control unit or it has troubles, follow the steps below.

1. WHEN THE AIR CONDITIONER IS STOPPED

If you want to turn on the air conditioner push the ON/OFF BUTTON (with the tip of a pen).

NOTE

The air conditioner will enter the automatic mode operation: it automatically selects the operating state according to the indoor temperature (cooling, heating, air supply), and cannot change the temperature setting value and fan speed.

2. WHEN THE AIR CONDITIONER IS RUNNING

If you want to turn off the air conditioner push the ON/OFF BUTTON (with the tip of a pen).

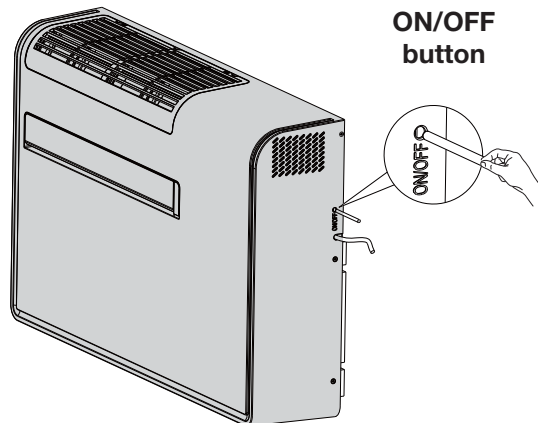

NOTE

Power failure during operation.

In the event of power failure, the unit will stop. When the power is resumed, the unit will restart automatically after 3 minutes.

TIPS FOR ENERGY SAVING

DO NOT:

- Block the air intake and outlet of the unit. If they are obstructed, the unit will not work well, and may be damaged.
- Let direct sunlight into the room. Use sunshades, blind or curtain.

DO:

- Always try to keep the air filter clean. A clogged filter will impair the performance of the unit.
- To prevent conditioned air from escaping, keep windows, doors and any other openings closed.

TROUBLESHOOTING



WARNING

- In case abnormal operation of the air conditioner is noticed, (operation LED lights, but the air conditioner does not run), try to restore normal operation turning-off electric supply for about 3 minutes, through the main switch or the wall plug, then start again the air conditioner.

If your air conditioner does not work properly, first check the following points before requesting service. If it still does not work properly, contact your dealer or service centre.

Trouble: the air conditioner does not run at all.

Possible cause:

1. Power failure.
2. Leakage breaker tripped.
3. Operation button is OFF.
4. Batteries in remote control unit have run down.

Remedy:

1. Restore power.
2. Contact service centre.
3. Press the button again.
4. Replace batteries.

Trouble: Poor cooling or heating performance.

Possible cause:

1. Dirty or clogged air filters.
2. Heat source or many people in room.
3. Doors and/or windows are open.
4. Obstacle near air intake or air discharge port.
5. The set temperature on the remote control unit is not right.
6. Outdoor temperature is too low.

Remedy:

1. Clean air filters to improve airflow.
2. Eliminate heat source if possible.
3. Shut them to keep the heat or cold out.
4. Remove it to ensure good airflow.
5. Set the right temperature on the remote control unit.
6. Try to use a back-up heater.

Trouble: Clicking sound is heard from the air conditioner.

Possible cause:

1. During operation, any plastic parts may expand or shrink due to a sudden temperature change. In this event, a clicking sound may occur.

Remedy:

1. This is normal, and the sound will disappear when an even temperature is settled.

Trouble: "Water flowing" noise.

Possible cause:

1. Was the air conditioner just turned on or off?

Remedy:

1. Noise is produced by the refrigerant flowing inside the unit (normal phenomenon).

Trouble: Air conditioner blows, just after turning on, odor or dust.

Possible cause:

1. The air conditioner itself will not smell. If there is an odor, it may be due to the accumulation of odors in the environment.
2. The air conditioner has not been used for a long time, and dust accumulated in the indoor unit is blown out.

Remedy:

2. Clean the filter. If you still have problems, please contact your dealer or service centre.

Trouble: During cooling operation, sometimes mist is blown out from the air outlet.

Possible cause:

1. This phenomenon sometimes occurs when the room temperature and humidity are high. This is because the indoor air is rapidly cooled.

Remedy:

1. After running for a while, the room temperature and humidity will decrease and the fog will disappear.

Trouble: The air conditioner is leaking.

Possible cause:

1. The air humidity is too high.
2. The condensed water overflows.
3. The connection of the unit drain pipe is loose.

Remedy:

1. If the air conditioner is operating under high humidity for a long time, moisture may condense on the air outlet grille, air deflector, panel, etc. and drip.

ERROR CODES' LIST				
Fault name	Fault definition	Code	LED display (on 0.5S and off 0.5S when the LED flashes)	
			STANDBY LED	HEATING LED
Jumper cap failure	Hardware failure	C5	stop 3 seconds, Flashing 15 times	
Memory chip read and write failure	Hardware failure	EE		stop 3 seconds, Flashing 15 times
Module current protection limit/ reduced frequency	remote control display	En	/	
Module temperature protection limit / reduced frequency	remote control display	EU		heating and cooling lights stop 3 seconds at the same time, flashes 6 times
System high voltage protection	other faults	E1	stop 3 seconds, Flashing 1 times	
Anti-freeze protection	other faults	E2	stop 3 seconds, Flashing 2 times	
System low voltage protection	other faults	E3	stop 3 seconds, Flashing 3 times	
Exhaust over heat protection	other faults	E4	stop 3 seconds, Flashing 4 times	
External AC current protection	other faults	E5	stop 3 seconds, Flashing 5 times	
Internal and external machine communication failure	Hardware failure	E6	stop 3 seconds, Flashing 6 times	
Mode conflict	Hardware failure	E7	stop 3 seconds, Flashing 7 times	
Overload temperature package failure	Hardware failure	FE (not shown)	/	
Anti-freeze protection limit / down-frequency	remote control display	FH		heating and cooling lights stop 3 seconds at the same time, flashes 2 times
fluorine receiving mode	The operating status immediately displays	Fo ("o" is the lower part of	The cooling and standby LEDs are turned off at the same time and the 3S flashes once	
Fluoride deficiency protection	other faults	F0		stop 3 seconds, Flashing 10 times
Indoor environmental temperature package failure	Hardware failure	F1		stop 3 seconds, Flashing 1 times
Indoor evaporator middle temperature package failure	hardware failure	F2		stop 3 seconds, Flashing 2 times
Outdoor environmental temperature package failure	Hardware failure	F3		stop 3 seconds, Flashing 3 times
Outdoor condenser temperature sensing package failure	Hardware failure	F4		stop 3 seconds, Flashing 4 times
Outdoor exhaust temperature package failure	Hardware failure	F5		stop 3 seconds, Flashing 5 times

ERROR CODES' LIST

Fault name	Fault definition	Code	LED display (on 0.5S and off 0.5S when the LED flashes)		
			STANDBY LED	COOLING LED	HEATING LED
Overload protection limit / reduced frequency	remote control display	F6		heating and cooling lights stop 3 seconds at the same time, flashes 1 times	
Oil return	30. Operation status (Direct display, other oil return needs remote control)	F7		stop 3 seconds, Flashing 7 times	
External machine AC current protection limit / reduced frequency	remote control display	F8		heating and cooling lights stop 3 seconds at the same time, flashes 4 times	
Exhaust protection limit / reduced frequency	remote control display	F9		heating and cooling lights stop 3 seconds at the same time, flashes 3 times	
PFC over current fault	other faults	HC		stop 3 seconds, Flashing 6 times	
Compressor demagnetization protection	other faults	HE		stop 3 seconds, Flashing 14 times	
Compressor overload protection	other faults	H3		stop 3 seconds, Flashing 3 times	
Overload pressure protection	other faults	H4		stop 3 seconds, Flashing 4 times	
Module current protection	other faults	H5		stop 3 seconds, Flashing 5 times	
Indoor fan failure	Hardware failure	H6	stop 3 seconds, Flashing 11 times		
Compressor out of step	other faults	H7		stop 3 seconds, Flashing 7 times	
Outdoor fan 2 failure	Hardware failure	LA	stop 3 seconds, Flashing 24 times		
Compressor startup failed	other faults	Lc		stop 3 seconds, Flashing 11 times	
Indoor and outdoor models do not match	Hardware failure	LP	stop 3 seconds, Flashing 19 times		
Outdoor fan 1 failure	Hardware failure	L3	stop 3 seconds, Flashing 23 times		
Excessive power protection	other faults	L9	stop 3 seconds, Flashing 20 times		
Internal machine undefined	Hardware failure	OE			

Note: The communication protocol requires the external machine to send the shutdown fault bit as a common bit for all faults.

When the defined faults occur at the same time, only the defined faults are displayed.

ERROR CODES' LIST

Fault name	Fault definition	Code	LED display (on 0.5S and off 0.5S when the LED flashes)		
			STANDBY LED	COOLING LED	HEATING LED
DC bus voltage is too high protection (external)	other faults	PH			stop 3 seconds, Flashing 11 times
DC bus voltage low protection (external unit)	other faults	PL			stop 3 seconds, Flashing 21 times
Capacitor charging failure (water level of wall penetrator)	Hardware failure	PU			stop 3 seconds, Flashing 17 times
Minimum cooling and heating (capability test code)	The running status is immediately displayed	P0			
Nominal cooling and heating (capability test code)	The running status is immediately displayed	P1	In the cooling test status: the cooling indicator flashes quickly (on for 0.25 seconds and off for 0.25 seconds)		
Maximum cooling and heating (capability test code)	The running status is immediately displayed	P2	heating test state: the heating indicator flashes quickly (on for 0.25 seconds and off for 0.25 seconds)		
Intermediate cooling and heating (capability test code)	The running status is immediately displayed	P3			
Compressor overcurrent peak current is too high	other faults	P5	/		stop 3 seconds, Flashing 15 times
Module temperature sensing circuit failure	Hardware failure	P7			stop 3 seconds, Flashing 18 times
Module temperature protection	other faults	P8			stop 3 seconds, Flashing 19 times
Compressor phase current detection failure	Hardware failure	U1			stop 3 seconds, Flashing 13 times
Compressor lack / reverse phase protection	other faults	U2			stop 3 seconds, Flashing 12 times
DC bus voltage drop fault	other faults	U3			stop 3 seconds, Flashing 20 times
Current detection failure	Hardware failure	U5		stop 3 seconds, Flashing 13 times	
Four-way valve switch abnormal	Hardware failure	U7		stop 3 seconds, Flashing 20 times	
Zero crossing signal abnormal	Hardware failure	U8	stop 3 seconds, Flashing 17 times		

HOW TO DISCHARGE THE CONDENSATE WATER

EN

The Humidity removed by the unit is collected and discharged automatically, but in special conditions some condensate water could remain inside the unit.

If you are not going to make use of the air conditioner for a long period, it is necessary to discharge the eventual condensate water through the service cap for condensate discharge placed under the bottom panel of the unit:

- Remove the cap, after having placed a good-sized container underneath it (at least 5-liter capacity) and empty the condensate.
- Replace the cap.



WARNING

- Always switch off the air conditioner before unplugging it from the power socket.
- Always unplug the air conditioner before discharging the condensate water collected inside.

If the condensate drain system is out of order, the air conditioner display panel will display "PU" and give an alarm signal.

To enable the air conditioner to work temporarily until the service personnel arrive, you can drain the water out by following the same procedure.

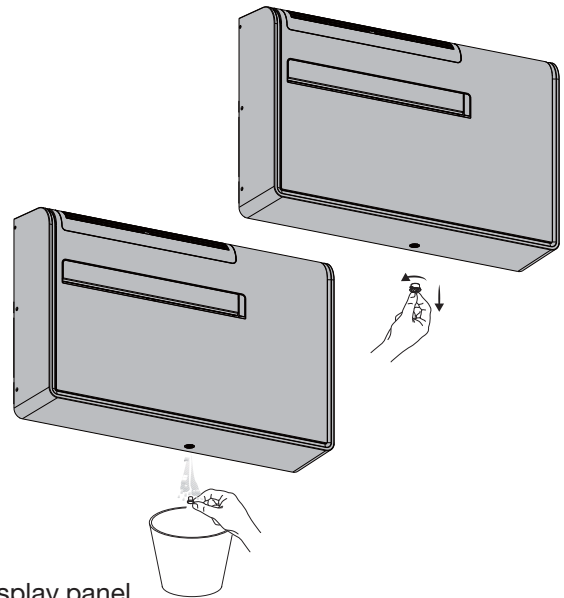

CARE AND CLEANING

WARNING! For safety's sake, be sure to turn the air conditioner OFF and also disconnect it from the power supply before cleaning it.

1. Cleaning of the Air Filter

The air filter must be checked at least once every two weeks operation. Operation with a dirty filter always causes a lower efficiency of the air conditioner and severe product damage. The air filter is located on the top of the unit, under the air intake grille:

- Unhook and manually remove the air intake grille, as shown in figure.
- Remove the two filters from the filter frame.
- Use a vacuum cleaner to remove light dust. If there is sticky dust on the filter, wash them with lukewarm soapy water, then rinse in clean, cold water and let them dry.
- Replace the filters in the filter frame and close the grille.

2. Cleaning of the unit

To clean the air conditioner, wipe it with a clean soft cloth, lightly moistened. In case it is stained, moisten the cloth with soapy water. Never use solvents or harsh chemicals, nor very hot water. Do not pour water over the air conditioner to clean it: this will damage the internal components and cause an electric shock hazard.

3. After use

If you are not going to make use of the air conditioner for a long period, clean the air filter and verify that there is no condensate water inside the bottom of the unit (see paragraph "HOW TO DISCHARGE THE CONDENSATE WATER"). Do not put heavy objects on top of the unit.

4. Transport

Keep the air conditioner in the vertical position during transportation.

- 5. For your safety care check periodically the conditions of the electric supply cable; the electrical connection of the unit is Y type with cable prepared in a special way; in case you should notice any damage due to usage, call the nearest After Sale Service to get the cable replaced.

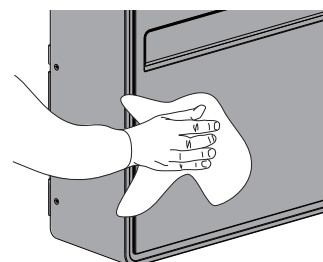
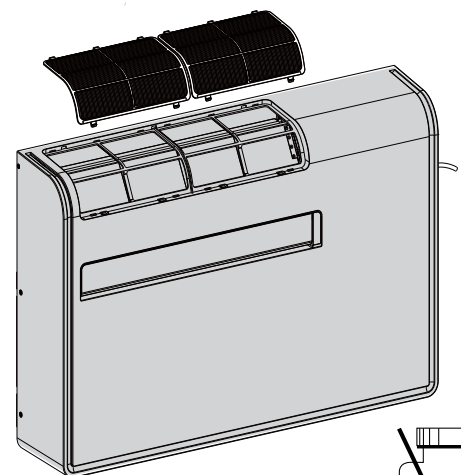
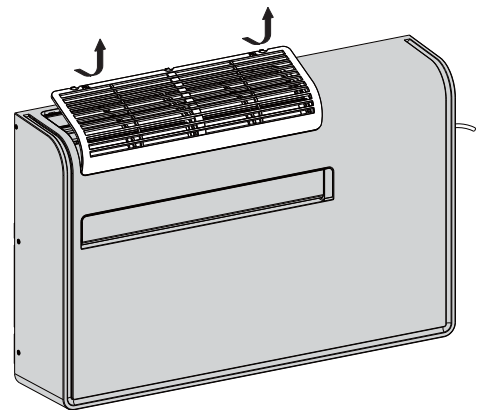

APP DOWNLOAD AND SETTING UP APOLLO IN WI-FI MODE

EN

1. Install the TuyaSmart App on your smartphone or tablet by framing the following QR code using a QR code reader (Alternatively, search and install the TuyaSmart App in the App store of your smartphone or tablet):
2. Open the TuyaSmart App.
3. If you don't have an account yet, create one.
4. Accedere all'app con le credenziali del proprio account.



5. Setting up Apollo in Wi-Fi mode:
 - a. Turn on the remote control
 - b. Set the dehumidification mode with the MODE key
 - c. Set the temperature to 20° C with the + and - keys
 - d. Set the timer (HOUR OFF) to 20 in the following way:
 - Press the TIME key once to set 20 (HOUR OFF will flash during the setting)
 - Press the + key until you reach 20 (HOUR OFF will flash during the setting)
 - Press the TIME button again to save the setting (HOUR OFF fixed)
 - e. Press the LIGHT button for 5 consecutive times (light bulb symbol)

ATTENTION: the symbol of the light bulb must appear on the remote control and the LEDs of the unit Apollo must be visible

- f. At this point the Wi-Fi light on Apollo starts flashing (see the figure)

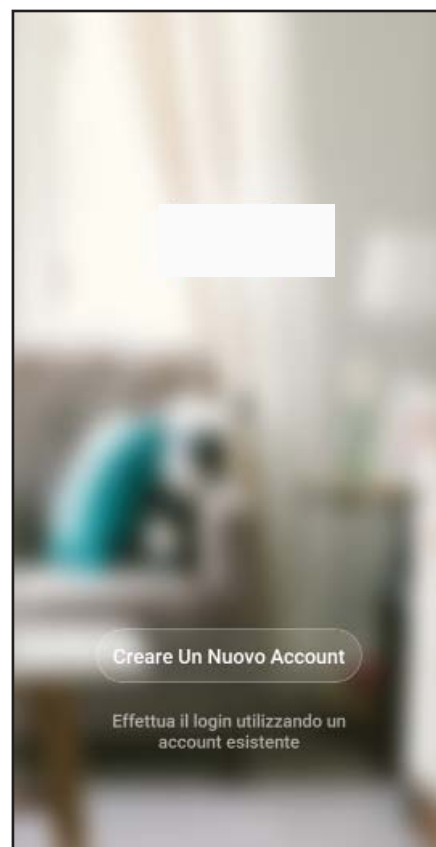
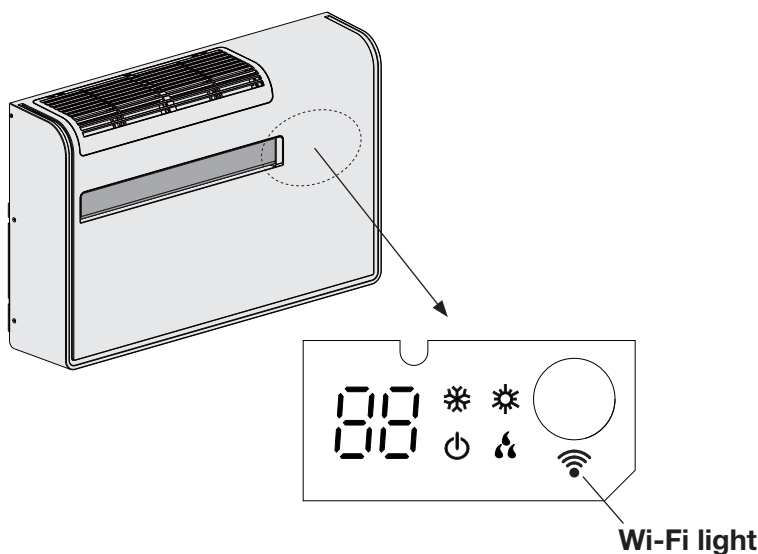

MINIMUM REQUIREMENTS FOR SMARTPHONE AND TABLET

With TuyaSmart App it is possible to manage the main functions of your air conditioner via smartphone and tablet.

To download and install the App, make sure that your device (smartphone or tablet) has a minimum standard version of the operating system: version 4.4 or higher for Android, version iOS 9.0 or higher for Apple.

NOTE

For Apollo connection to TuyaSmart App and use of Apollo via TuyaSmart App, see section at the end of this manual (Wi-Fi GUIDE).



INFORMATION FOR CORRECT DISPOSAL OF THE PRODUCT IN ACCORDANCE WITH THE EUROPEAN DIRECTIVE 2012/19/EU

At the end of its working life this equipment must not be disposed of as an household waste. It must be taken to special local community waste collection centres or to a dealer providing this service. Disposing of an electrical and electronic equipment separately avoids possible negative effects on the environment and human health deriving from an inappropriate disposal and enables its components to be recovered and recycled to obtain significant savings in energy and resources. In order to underline the duty to dispose of this equipment separately, the product is marked with a crossed-out dustbin.



INFORMATION FOR CORRECT DISPOSAL OF THE BATTERY IN ACCORDANCE WITH THE EUROPEAN DIRECTIVE 2006/66/EC

Please replace battery when its electricity charge is used up: please do not eliminate this battery together with normal household waste. It must be taken to special local community waste collection centres or to a dealer providing this service. Disposing of a battery separately avoids possible negative effects on the environment and human health deriving from an inappropriate disposal and enables its components to be recovered and recycled to obtain significant savings in energy and resources. In order to underline the duty to dispose of this equipment separately, the battery is marked with a crossed-out dustbin.

Wi-Fi GUIDE (English / Italian)

GUIDA Wi-Fi (Inglese / Italiano)

GUIDE Wi-Fi (Anglais / Italien)

LEITFADEN ZU Wi-Fi (Englisch / Italienisch)

GUÍA Wi-Fi (Inglés / Italiano)

GUIA DE Wi-Fi (Inglês / Italiano)

CONNECT APOLLO TO TUYASMART APP

1. Click on
“Add device”

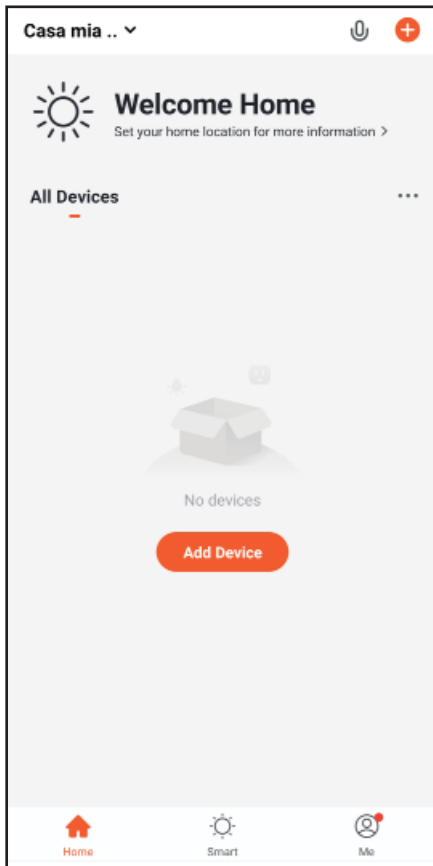

2. In the left bar select
“Large Home Appliance”

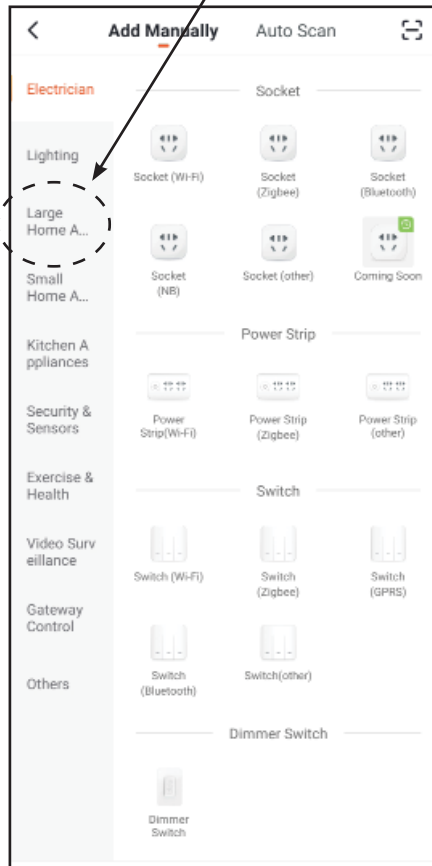

3. In the right area select “”
“Air Conditioner”

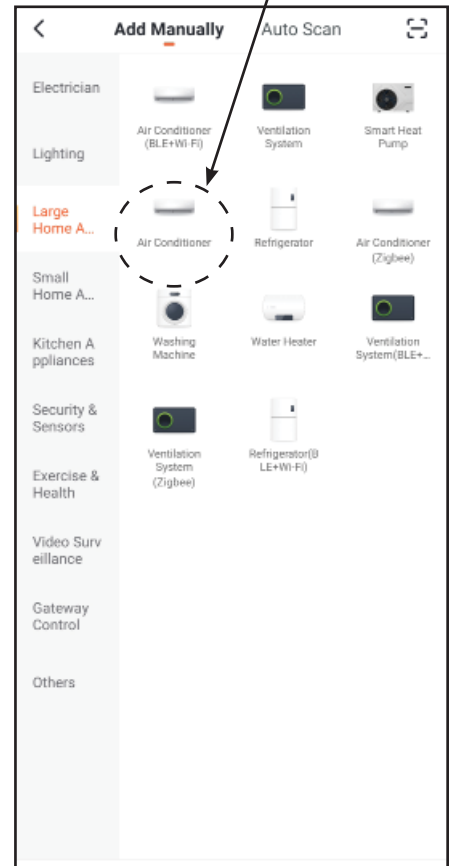

4. After allowing the App to access the position according to the desired data, select the Wi-Fi network to which you want to connect Apollo and enter the network password where the unit is installed, then click on “Next”

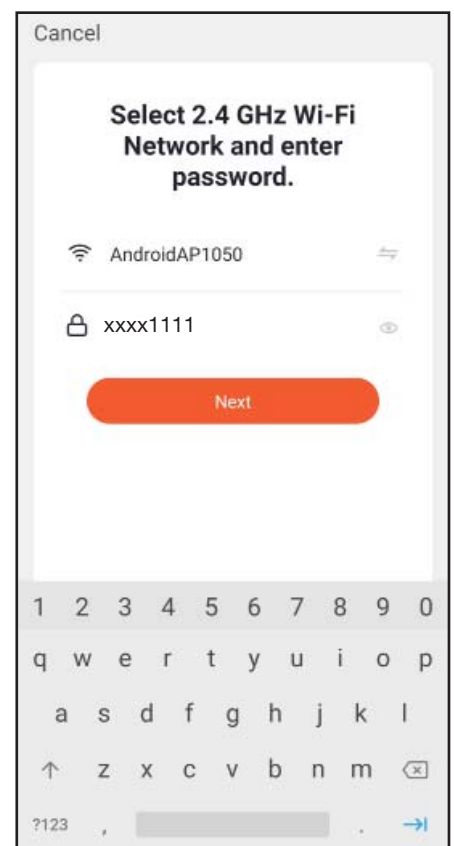
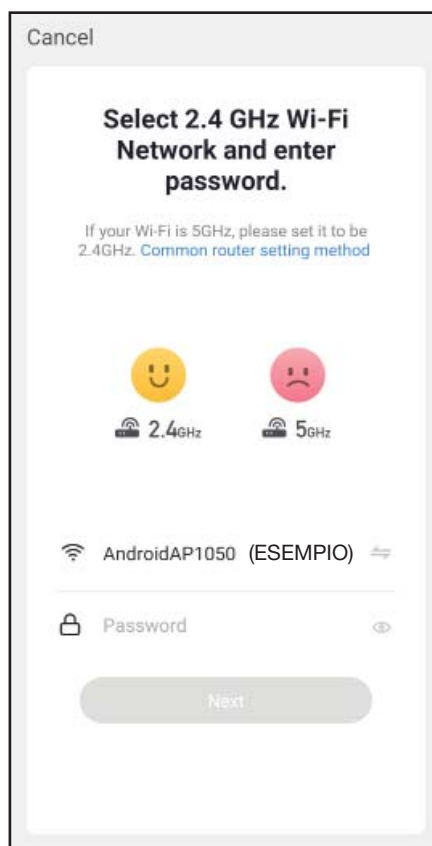
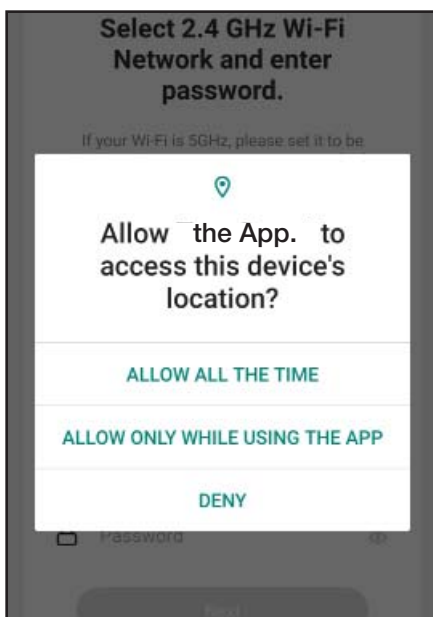

5. After checking that the Wi-Fi light on Apollo is blinking rapidly, click on “”

“Confirm indicator rapidly blink”

6. Wait for the pairing process between the Smartphone and the unit Apollo to end successfully and click on **“Done”**

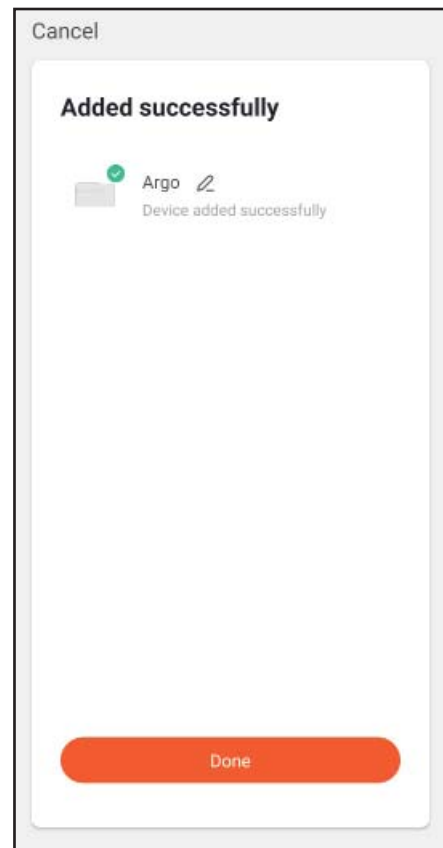
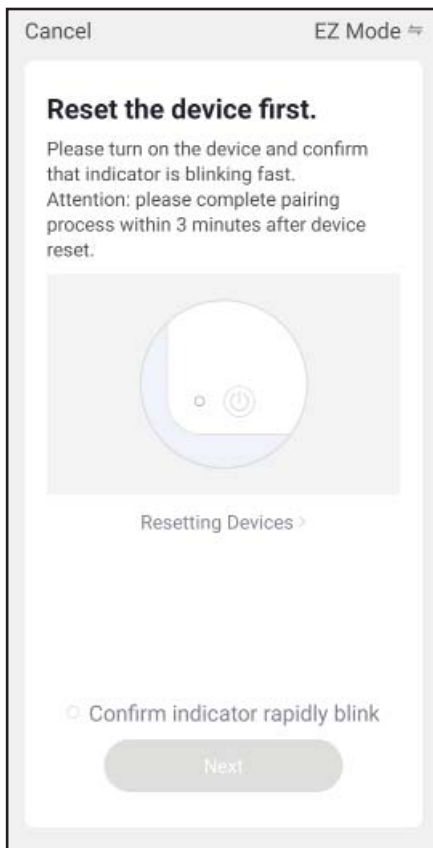

Once everything is set, the Wi-Fi light on the unit will remain fixed and the Smartphone can be used for all available functions.

USE APOLLO VIA TUYASMART APP

Open the app and use the available controls for the unit Apollo.

FIRST SCREEN AFTER THE CONNECTING PROCEDURE

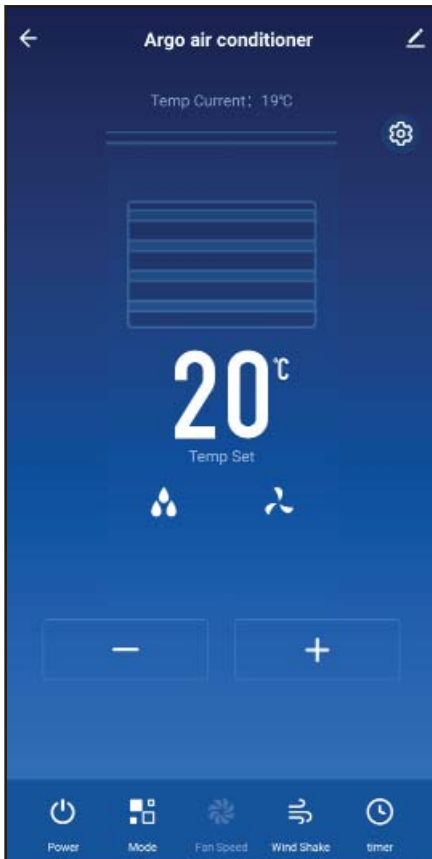

HEATING MODE SETTING (HOT)

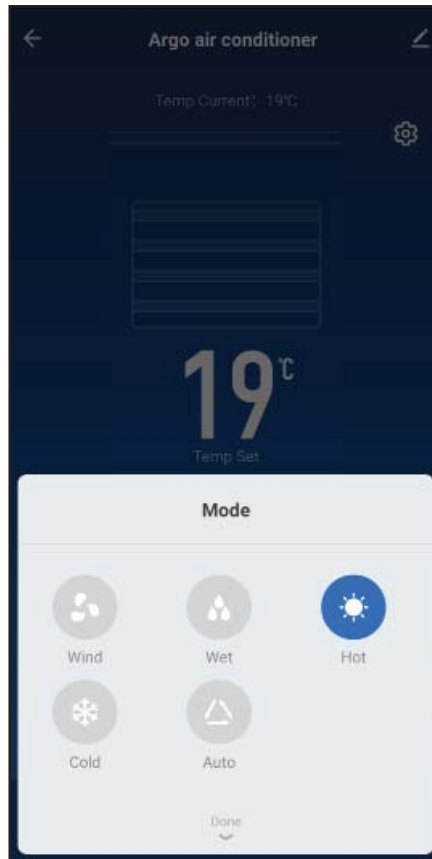

TEMPERATURE SETTING + and -



FAN SPEED (AUTO)

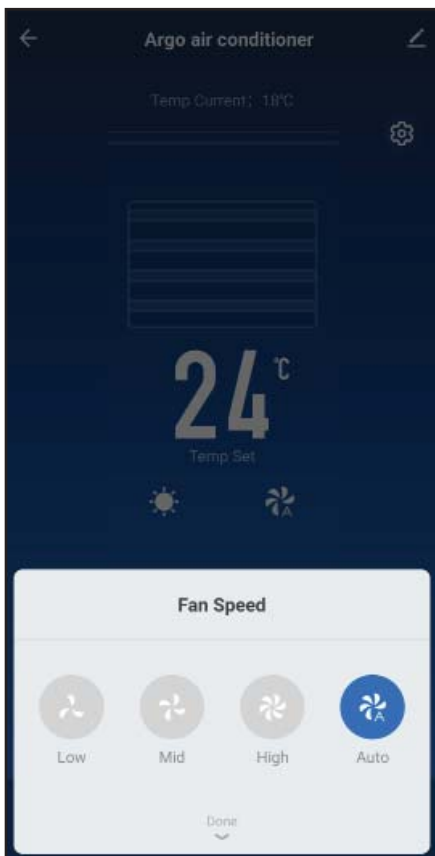

FLAP POSITION

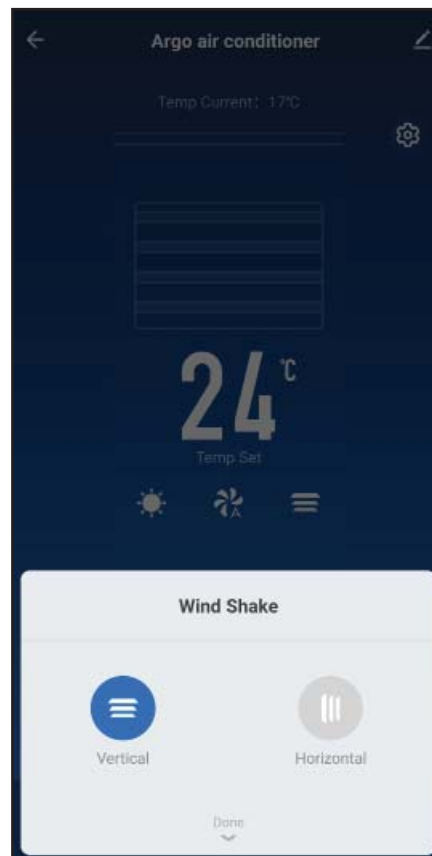

COOLING MODE SETTING (COLD)

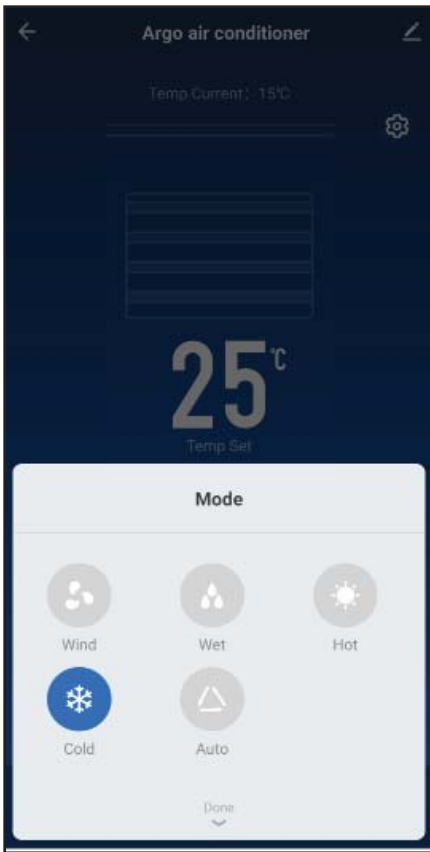

AUTOMATIC MODE SETTING (AUTO)

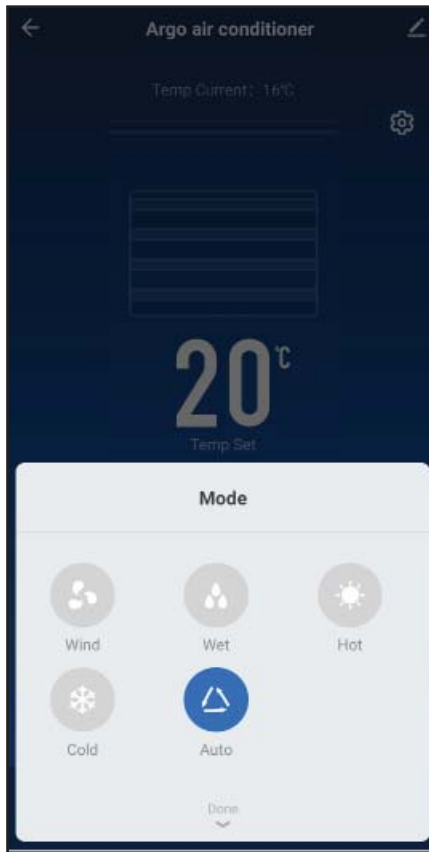

FAN MODE SETTING (WIND)

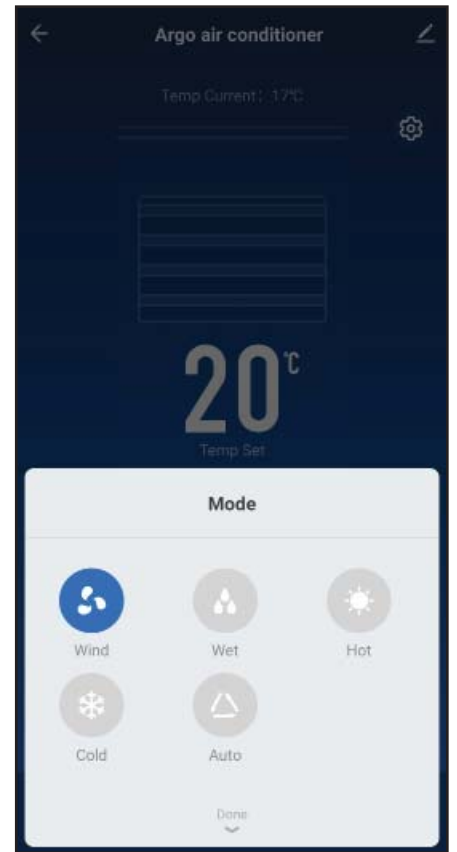

**UNIT IN STAND-BY
IT IS POSSIBLE TO SELECT THE
TIMER**

TIMER: If you use the Timer to turn the unit on/off (Power ON/Power OFF) at the desired hours and days, remember that the system works according to to the previous settings.

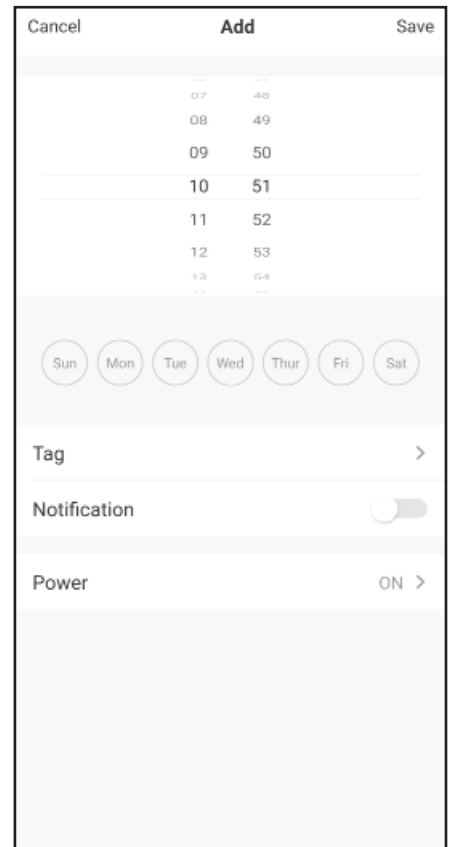
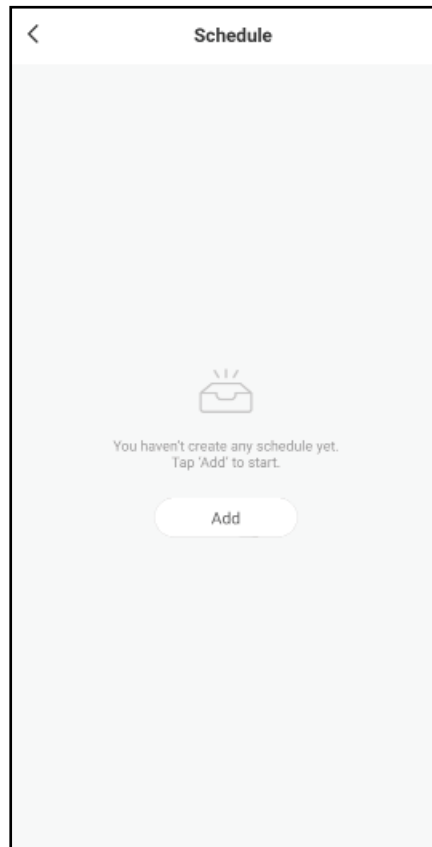

ATTENTION: Once the timer is set, you can decide to activate or deactivate it, if necessary, or to delete the setting.

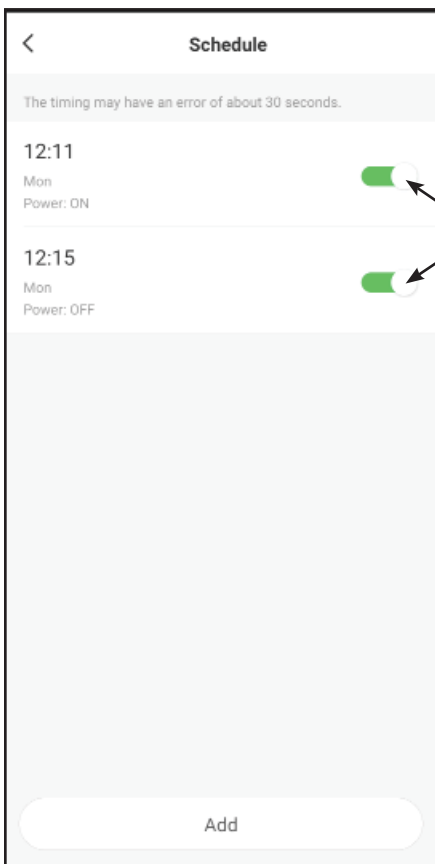

ACTIVATE / DEACTIVATE

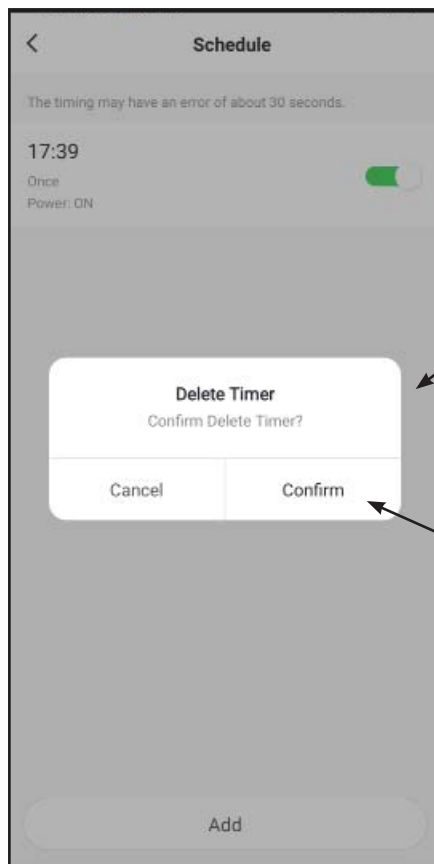

CLICK ON THE TIME TO BE DELETED

THEN CONFIRM

SPECIAL FUNCTIONS (SETTING)



CLICK HERE TO ENTER THE SPECIAL FUNCTIONS

CORRISPONDENTI A TASTI TELECOMANDO:

	Setting	
/	Silent	<input checked="" type="checkbox"/>
ECO	ECO	<input type="checkbox"/>
SLEEP	Sleep	<input type="checkbox"/>
	Heat	<input type="checkbox"/>
LIGHT	Light	<input checked="" type="checkbox"/>
TURBO	Strong	<input type="checkbox"/>

NOTES:

The use of the remote control has priority over the App.
The images used are for informational purposes only.

argoclima s.p.a.

Società a socio unico

Via Alfeno Varo, 35 - 25020 Alfianello - BS - Italy

Tel. +39 030 7285700

www.argoclima.com