



improve your life

CE

EN

NANTE

TOWER FAN



OPERATING INSTRUCTIONS

Read the instructions carefully before operating the appliance or carrying out maintenance work. Observe all the safety instructions; failure to do so may lead to accidents and/or damage. Store these instructions in a safe place for future reference.

GENERAL OPERATING AND SAFETY INSTRUCTIONS

- Use this fan only as described in this manual. Any other use not recommended by the manufacturer can cause fires, electric shocks, or personal injury.
- Make sure that the type of power supply complies with the electrical demands of the fan (220-240V~50/60Hz).
- This product is not a toy. Children must be duly supervised to ensure that they do not play with the appliance.
- Children must not play with the appliance
- This appliance can be used by children of at least 8 years of age and by people with reduced physical, sensory or mental capabilities, or with lack of experience or knowledge, if they have been able to benefit, through the intermediation of a person responsible for their safety, supervision or instructions regarding the use of the fan and therefore have understood the possible risks inherent to it.
- Cleaning and maintenance intended to be carried out by the user must not be carried out by children without supervision.
- Do not restrict the air inlet and outlet grilles.
- Disconnect the mains power supply when not in use or cleaning.
- Do not place anything on the product; do not hang wet clothes on the fan.
- Do not allow fingers or foreign objects to enter the air inlet or outlet grilles as this may cause an electric shock or fire or damage the fan.
- To prevent fire, do not block or tamper with the grilles in any way while the fan is in operation.
- **Do not use the appliance if the cord or plug is damaged.** If the power cable is damaged, it must be replaced by the manufacturer or its technical assistance service or in any case by a person with similar qualifications, in order to prevent any risk.
- Make sure the appliance is disconnected from the mains before removing any component.
- Do not use the fan if it has been dropped from a height or damaged in any way. Contact a service center to have the fan checked or to carry out electrical or mechanical repairs.
- The most common cause of overheating is the accumulation of dust in the unit. Remove accumulations of dust by unplugging and cleaning the

grids with the help of a vacuum cleaner.

- Do not use abrasive products to clean the appliance. Clean it with the help of a damp (not wet) cloth and let it dry completely before putting it away. Remove the plug from the socket before doing maintenance.
- To disconnect the fan, turn the switch to the OFF position and remove the plug from the outlet. Just pull the plug. Do not pull the cord when turning off the fan.
- Do not place anything on the power cord or bend the cord.
- The use of extension cords is not recommended, because the extension cord could overheat and cause a risk of fire. Never use a single extension cord to operate more than one appliance.
- Do not immerse the cord, plug or any other element of the appliance in water or other liquids.
- Do not touch the plug with wet hands.
- Do not place the fan on or near another heat source, such as stoves, radiators, or other heat-producing appliances.
- Avoid exposing the device to direct sunlight.
- Do not connect the fan to the power supply until it has been correctly assembled or positioned.
- Do not run the cord under carpets. Do not cover the cable with blankets, carpets or the like. Place the cord away from busy areas or where it cannot be accidentally pulled out.
- Keep flammable materials such as furniture, cushions, blankets, papers, clothes, curtains and so on at a distance of 1 m from the front, sides and rear.
- Do not use the fan in dusty environments or in the presence of flammable vapors (for example in a workshop or garage).
- A fan has parts inside that generate arcs or sparks. It should not be used in areas that could be hazardous such as areas with risk of fire, explosion, chemical laden or moisture laden atmosphere.
- Do not use the fan in the immediate vicinity of bathtubs, showers, washbasins and swimming pools.
- Use the fan in a well-ventilated area.
- Do not place the fan under an outlet.
- Do not use outdoors.

ATTENTION:

THE ON/OFF SWITCH IS NOT THE ONLY MEANS TO DISCONNECT THE POWER SUPPLY.

IN THE EVENT OF NOT USING, MOVING OR MAINTAINING THE APPLIANCE, ALWAYS UNPLUG THE PLUG FROM THE SOCKET.

- Do not use the appliance on soft surfaces, such as a bed, where the grids may be covered. Always place the fan on a stable, level surface when in operation to prevent the fan from tipping over. Place the cable so that the fan or other objects do not rest on it.
- Always pull the plug when the appliance is not in use.
- In order to avoid accidents, switch off the unit when unattended.
- In the event of anomalies (anomalous noise or a strange smell), switch off the appliance immediately, do not attempt to repair it and take it to the local authorized technical assistance centre.
- Use the handle on the back to move the product.

DESCRIPTION OF THE APPLIANCE

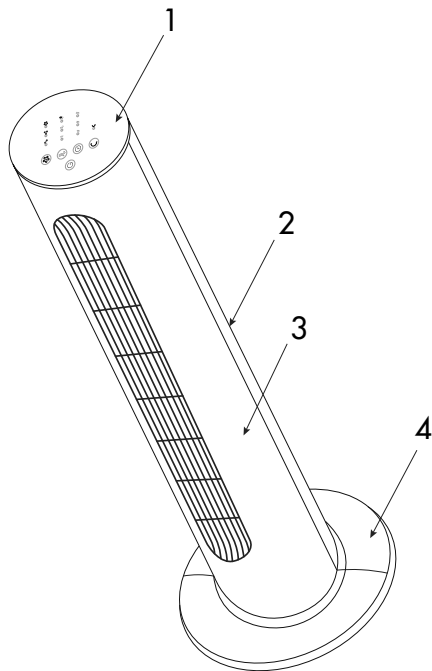

1. Control panel
2. Rear panel
3. Front panel
4. Base

INSTALLATION OF BASE

Before putting the appliance into operation, it is necessary to assemble and mount the base.

- Hook the front base and the rear base, fixing them with two screws (Fig.1)
- Install the base on the appliance, fixing it with 4 screws (Fig.2)

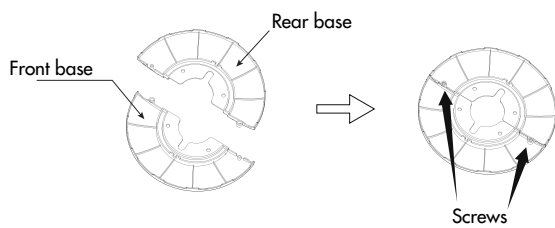

Fig.1

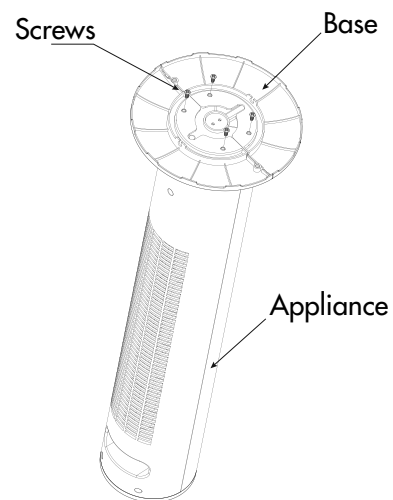

Fig.2

FUNCTION CONTROLS

BY REMOTE CONTROLLER

How to insert the battery into the remote controller

Open the battery door on the back of the remote controller by pressing the back and pulling the door. Place the battery in the door, taking care to check that the polarities are positioned correctly. Insert the door into the remote controller.

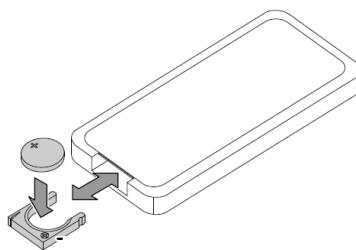

Use a Lithium/Manganese button cell, model no. CR2025 -3 V (supplied), compliant with Battery Directive no. 2006/66/EC and amendments by Directive 56/2013/EU.

Do not use new batteries with dead batteries. If the remote controller is not used for a long time, remove the battery. Make sure you dispose of the battery properly.

WARNINGS FOR BATTERIES

- Batteries should not be exposed to heat sources such as fire, sun or similar sources;
- remove the batteries if they start to heat up or you know you will not use the appliance for a long time the batteries must be installed correctly in the battery compartment;
- when removing the batteries because they are at the end of their life or damaged, comply with the national regulations in force for disposal (shown below);
- In the event of a battery fluid leak, remove all batteries, taking care not to let the leaked fluid come into contact with skin or clothes.

If liquid from the battery gets on your skin or clothing, wash the skin with water immediately. Before inserting new batteries, thoroughly clean the battery compartment with a dry paper towel, or follow the battery manufacturer's recommendations for cleaning. Only use batteries of the same size and type.

Caution: Danger of explosion if battery is replaced by a type other than that specified.

Improper use of batteries can cause them to leak, overheat, or explode. This liquid is corrosive and can be toxic. It can cause skin and eye burns, and is harmful to ingest.

To reduce the risk of injury:

- Keep batteries out of the reach of children.
- Do not heat, open, puncture, cut or throw batteries into fire.
- Do not mix old and new batteries or batteries of different types
- Do not leave metal objects that could come into contact with the battery terminals and therefore could heat up and/or cause burns.



INFORMATION FOR THE CORRECT DISPOSAL OF BATTERIES IN ACCORDANCE WITH EUROPEAN DIRECTIVE 2006/66/EC and amendments Directive 2013/56/EU

Replace batteries when they are depleted. At the end of their life, batteries must be disposed of separately from unsorted waste. They must be taken to designated recycling centres or returned to a retailer providing this service. Separate disposal of batteries prevents potential negative effects on the environment and human health due to inadequate disposal, and also allows for recovering and recycling their constituent materials, resulting in significant savings in terms of energy and resources. The separate disposal obligation is underlined by the crossed-out dustbin symbol appearing on the battery. Illegal disposal of the product by the user implies administrative sanctions applied as per current regulations.

FOR OPTIMAL REMOTE CONTROLLER OPERATION, POINT THE TRANSMITTER HEAD TOWARDS THE RECEIVER LOCATED ON THE FAN.

CONTROL BY REMOTE CONTROLLER

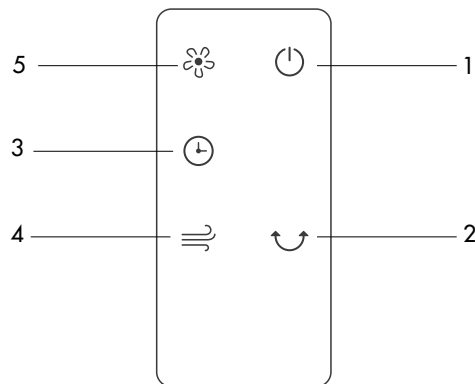

- 1. ON/OFF button
- 2. Swing button
- 3. Timer button
- 4. Mode button
- 5. Fan Speed button

CONTROL BY CONTROL PANEL

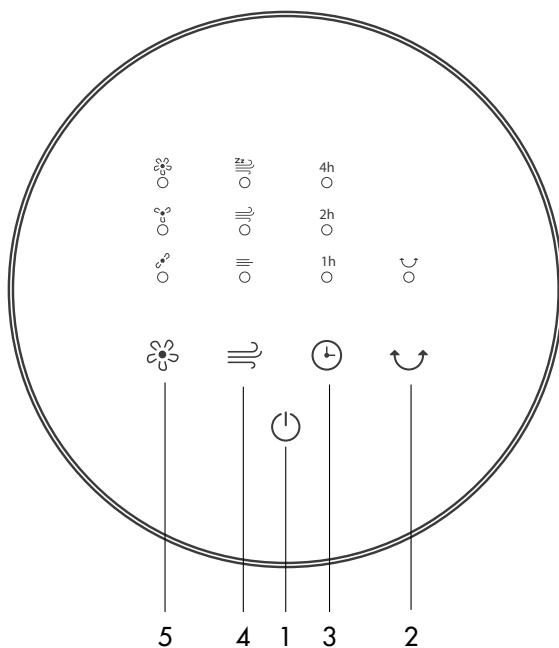

- 1. ON/OFF button
- 2. Swing button
- 3. Timer button
- 4. Mode button
- 5. Fan Speed button

FUNCTION OF THE BUTTONS ON THE REMOTE CONTROLLER AND CONTROL PANEL

1. ON/OFF BUTTON

Press this button on the control panel or remote controller to turn the unit on and off.

2. SWING BUTTON

Press this button on the control panel or remote controller to activate or deactivate the automatic swing function of the unit.

3. TIMER BUTTON

Press this button on the control panel to set the operation Timer. Each time this button is pressed, it is possible to adjust the operating interval as follows: 1h - 2h - 4h, the corresponding LEDs light up on the control panel according to the selection made. It is possible to combine the desired time up to a maximum of 7 hours.

On the remote controller, instead, press the Timer button, it will then be possible to select the desired time, displaying the LEDs on the control panel to set the operating interval.

4. MODE BUTTON

Press this button on the control panel or on the remote controller to select the operating mode, in the following circular sequence: Normal - Natural - Sleep

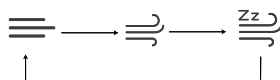

On the control panel, the LEDs light up according to the selection made.

5. FAN SPEED BUTTON

Press this button on the control panel or on the remote controller to select the fan speed, in the following circular sequence: High - Medium - Low

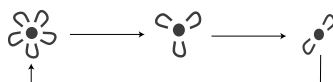

On the control panel, the LEDs light up according to the selection made.

CARE AND MAINTENANCE

WARNING!

Before carrying out any cleaning or maintenance operations, unplug the appliance.

IMPORTANT: DO NOT SUBMERGE THE FAN IN WATER.

1. Cleaning the casing

Turn off the fan and remove the plug before cleaning. To move the appliance, always use the handle located on the back of the appliance.

Use a soft cloth to remove dust from the product. If this is not enough, use a soft cloth moistened with water and neutral detergent at a temperature below 40°C.

Let the appliance dry completely before using it.

Do not apply corrosive cleaners or solvents such as benzene. Do not wash the appliance with water.

When cleaning, do not use oils, chemicals or other objects that could damage the surface.

Use a vacuum cleaner to remove dust from the air inlet and outlet grilles.

2. Storage

During periods of non-use, unplug the power cord and store the appliance together with this manual in the original box in a cool, well-ventilated place.

3. For complete safety, regularly check the condition of the power cord; should it be damaged as a result of wear, contact the Service Centre to replace it.



INFORMATION FOR CORRECT DISPOSAL OF THE PRODUCT IN ACCORDANCE WITH THE EUROPEAN DIRECTIVE 2012/19/EU

At the end of its working life this equipment must not be disposed of as an household waste. It must be taken to special local community waste collection centres or to a dealer providing this service. Disposing of electrical and electronic equipment separately avoids possible negative effects on the environment and human health deriving from an inappropriate disposal and enables its components to be recovered and recycled to obtain significant savings in energy and resources. In order to underline the duty to dispose of this equipment separately, the product is marked with a crossed-out dustbin.



improve your life

www.argoclima.com

Argoclima assumes no responsibility for any errors or inaccuracies in the content of this manual and reserves the right to make to this, at any time and without notice, any changes deemed appropriate for any technical or commercial need.