



improve your life

ECOWALL
SINGLE SPLIT AIR
CONDITIONERS – R32

USER MANUAL and INSTALLATION GUIDE

INDOOR UNIT

ECOWALL 9000 UI (WIFI)

ECOWALL 12000 UI (WIFI)

ECOWALL 18000 UI (WIFI)

ECOWALL 24000 UI (WIFI)

OUTDOOR UNIT

ECOWALL 9000 UE

ECOWALL 12000 UE

ECOWALL 18000 UE

ECOWALL 24000 UE



Please read this manual carefully before installing and using the air conditioner, and retain for future reference.

Contents

Information for use	
The Refrigerant	43
Precautions for use	44
Description of components	46
Guide to the remote control and display	
Remote control buttons	47
Getting to know the display icons	48
Getting to know the remote control buttons	48
Getting to know the button combination functions	51
Operating guide	51
Replacing the remote control batteries	52
WiFi guide	53
Emergency operation	63
Maintenance	
Care and cleaning	63
Troubleshooting	
Possible faults and solutions	64
Analysing faults and solutions	66
Installation instructions	
Installation warnings	68
Choosing a location for installation	68
Electrical connection requirements	69
Installation	
Indoor unit installation	69
Outdoor unit installation	73
Post-installation checks	76
Testing and operation	
Functional testing	77
Appendices	
Piping configuration	77
Safety operation of flammable refrigerant	78
Procedure for extending the piping	79



INFORMATION FOR CORRECT DISPOSAL OF THE PRODUCT IN ACCORDANCE WITH THE EUROPEAN DIRECTIVE 2012/19/EU

At the end of its working life this equipment must not be disposed of as an household waste. It must be taken to special local community waste collection centres or to a dealer providing this service. Disposing of electrical and electronic equipment separately avoids possible negative effects on the environment and human health deriving from an inappropriate disposal and enables its components to be recovered and recycled to obtain significant savings in energy and resources. In order to underline the duty to dispose of this equipment separately, the product is marked with a crossed-out dustbin.



Appliance filled with flammable gas R32.



Before using the appliance, read the owner's manual.



Before installing the appliance, read the installation manual.



Before repairing the appliance, read the service manual.

The Refrigerant

- To realize the function of the air conditioner unit, a special refrigerant circulates in the system. The refrigerant is the fluoride R32 = GWP (Global warming potential). This refrigerant is flammable and inodorous. It can lead to explosions under certain conditions, however the flammability of this refrigerant is very low and it can be ignited only by fire.
- Compared to other common refrigerants, R32 is a non-polluting refrigerant with no harm to the ozoneosphere and a lower effect upon the greenhouse effect. R32 has very good thermodynamic features which lead to a really high energy efficiency. The units therefore need less filling.

Warning:

Do not try to accelerate the defrosting process or to clean the appliance in different ways other than those recommended by the manufacturer. Should repair be necessary, contact your nearest authorized Argoclima Service Centre. Any repairs carried out by unqualified personnel may be dangerous. The appliance has to be stored in a room that doesn't have any continuously operating ignition sources. (for example: open flames, an operating gas appliance or an operating electric heater.) Do not pierce or burn.

Appliance has to be installed, operated and stored in a room with a floor area larger than X m². (Please refer to table "a" in section of " Safety Operation of Inflammable Refrigerant" for Space X.) For repairs, strictly follow manufacturer's instructions only for appliances filled with R32 flammable gas. Be aware that refrigerants do not have any odour.



INFORMATION FOR USE









Precautions for use

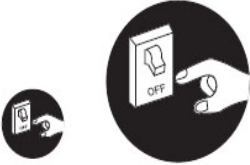

WARNING

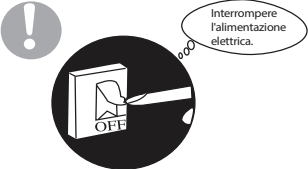
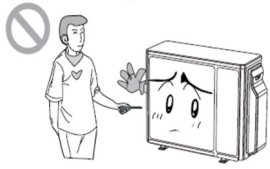
- This product is not a toy. Children of less than 3 years should be kept away unless continuously supervised.
- This device is not intended for persons (including children aged from 8 years and above) with reduced physical, sensory or mental capabilities, or without the necessary experience and knowledge, unless they have received the necessary supervision or instruction concerning use of the appliance by a person responsible for their safety.
- Children aged from 3 and less than 8 years shall only switch on/off the appliance provided that it has been placed or installed in its intended normal operating position and they have been given instruction concerning use of the appliance in a safe way and understand the hazards involved. Children aged from 3 years and less than 8 years shall not plug in, regulate and clean the appliance or perform user maintenance.
- To prevent the risk of fire, do not connect the air conditioner to a multifunction socket.
- Always disconnect the power before servicing or cleaning the unit.
- To prevent the risk of electric shock or malfunction, do not spray water on the indoor unit.
- Do not spill water on the remote control.
- To prevent the risk of electrical shock or damage, do not attempt to repair the air conditioner yourself. After performing the checks in the troubleshooting section, contact an authorised service centre.
- Do not obstruct the inlet or outlet. Otherwise, a fault may occur.
- Contact a qualified technician if it is necessary to move the air conditioner to another location.
- Do not climb on or place heavy objects on the top panel of the outdoor unit. Otherwise, there is a risk of damage or personal injury.
- Do not put fingers or other objects in the air inlet/outlet grilles. Otherwise, there is a risk of damage or personal injury.
- The air conditioner must be properly earthed. Improper earthing can cause electrical shock.

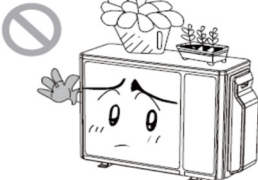
- Always install a circuit breaker. Otherwise, a fault may occur.
- The unit must be installed and serviced by a qualified technician. Otherwise, there is a risk of damage or personal injury.

WARNING		
<p>★ In case of smoke or burning smell, turn off the power supply and contact the service center.</p>  <p>If the problem persists, the unit could be damaged and cause electrical shock or fire.</p>	<p>★ It is necessary that power supply adopts the special circuit with protection through an air switch and ensure it has sufficient capacity. The unit switches on or off automatically according to user needs: do not turn on or turn off the device frequently otherwise it could suffer harmful effects.</p>	<p>★ Do not cut or damage the power cords and control cables. If the power cable and the cable of the control signal are damaged, they must be replaced by a professional technician.</p> 
<p>★ The power supply must be equipped with a special circuit to prevent fire.</p>  <p>Otherwise, it may result in fire or electric shock.</p>	<p>★ Disconnect the power supply if the air conditioner is not used for a long time</p>  <p>Otherwise, the accumulation of dust can cause overheating.</p>	<p>★ Do not damage the power cord or use an unauthorized cable.</p>  <p>Otherwise, it may cause overheating or fire.</p>
<p>★ When cleaning the unit, stop operation and turn off the power.</p>  <p>Otherwise, may occur electric shock or damage.</p>	<p>★ The voltage rating of this product is 220 - 240V, 50Hz. The compressor vibrates strongly if the voltage is too low, causing damage to the cooling system. The electrical components are easily damaged if the voltage is too high.</p>	<p>★ Do not attempt to repair the air conditioner yourself.</p>  <p>An improper repair can cause fire or electric shock. For this reason, it is advisable to contact a service center for repairs.</p>
<p>★ Check if the installed media is sufficiently stable.</p>  <p>If damaged, it can cause the equipment to fall and cause injury.</p>	<p>★ Do not climb on the outdoor unit or place anything on it.</p>  <p>The falling of the outdoor unit can be dangerous</p>	<p>★ Earthing: The unit must be properly grounded. The cable grounding must be connected with the appropriate device in the building.</p>  

Operating limits

Operating range:

Cooling mode: from -15°C to +43°C (outdoor temperature)

Heating mode: from -15°C to +24°C (outdoor temperature)

Description of components

Indoor unit

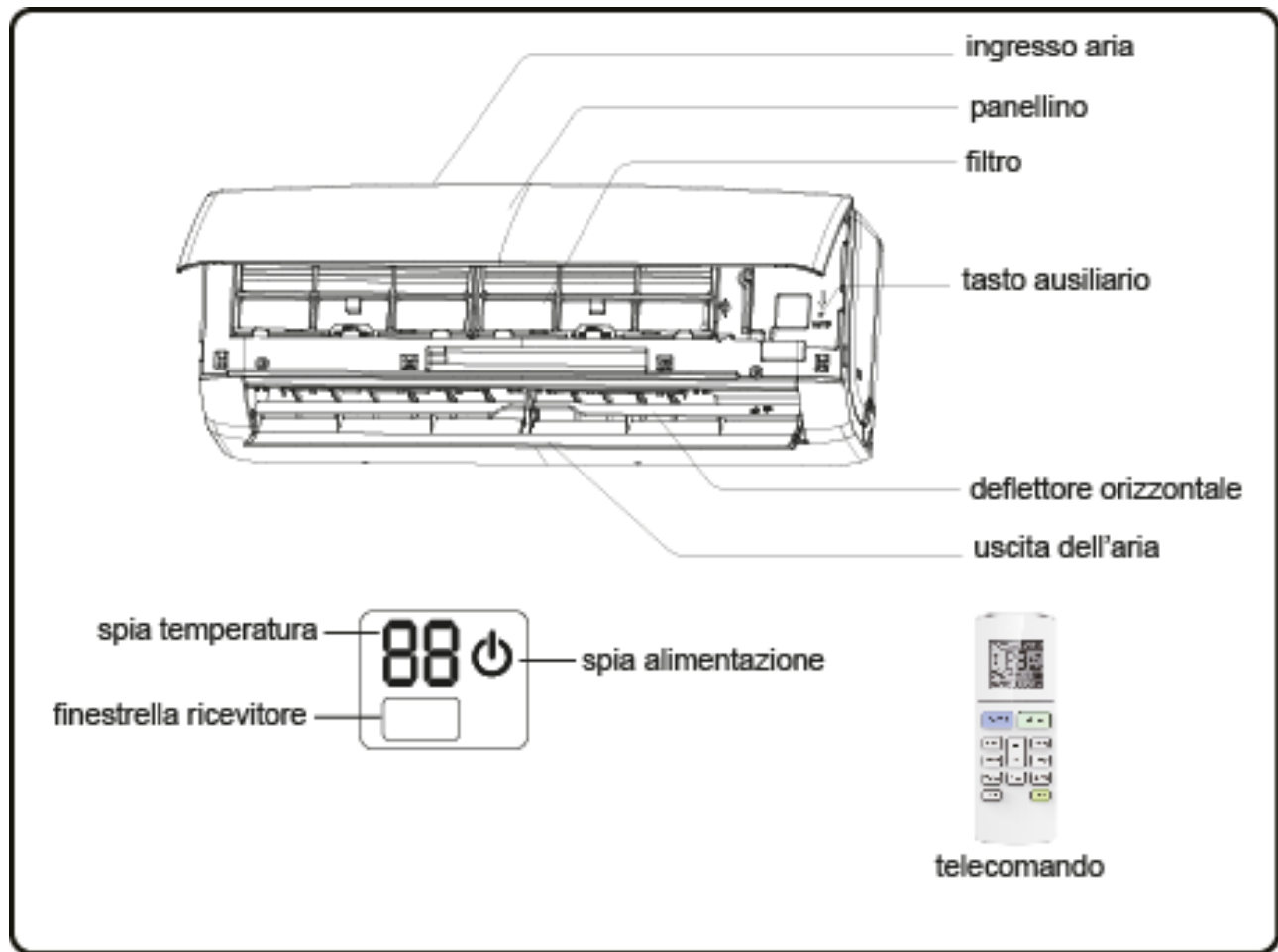

ingresso aria	air inlet
panellino	panel
filtro	filter
Tasto ausiliario	auxiliary button
Deflettore orizzontale	horizontal flap
uscitadell'aria	air outlet
Spia alimentazione	power indicator
Finestrella ricevitore	receiver window
Spia temperatura	temperature indicator
telecomando	remote control

The display may vary from the graphic above. Please refer to the purchased product for the actual display content and positions)

Outdoor unit

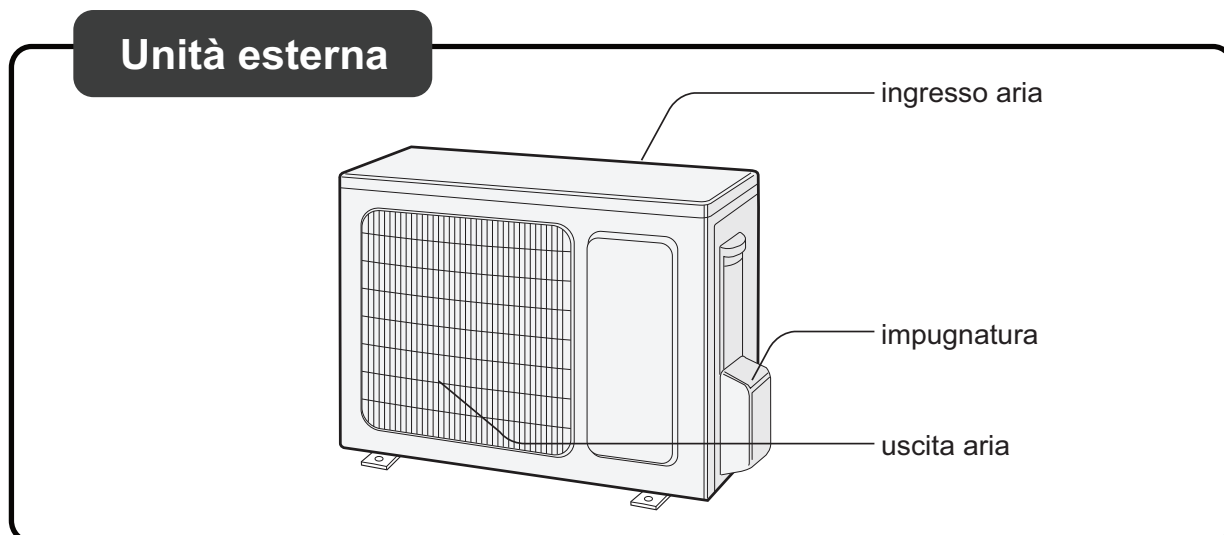

Unità esterna	Outdoor unit
ingresso aria	air inlet
impugnatura	handle
uscita aria	air outlet

GUIDE TO THE REMOTE CONTROL AND DISPLAY

Remote control buttons

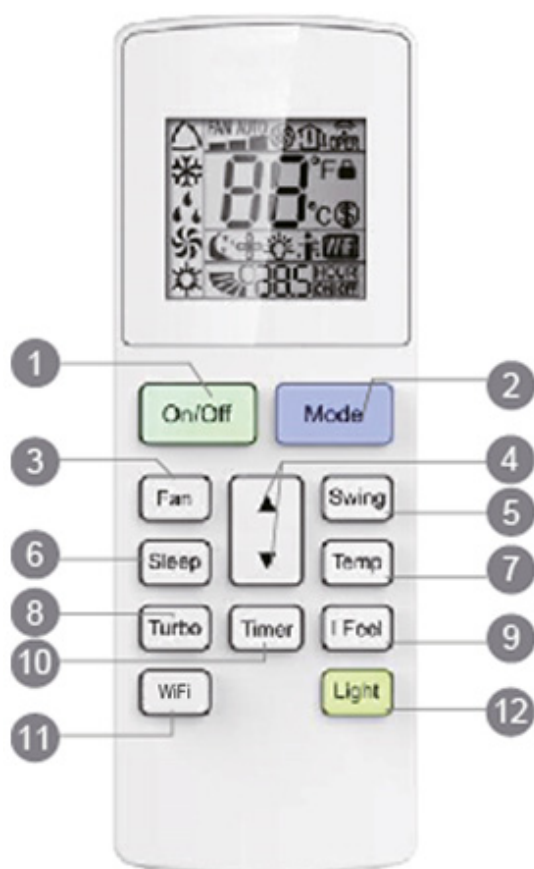

1. ON/OFF BUTTON
2. MODE BUTTON
3. FAN BUTTON
4. ▲/▼ BUTTON
5. SWING BUTTON
6. SLEEP BUTTON
7. TEMP BUTTON
8. TURBO BUTTON
9. I FEEL BUTTON
10. TIMER BUTTON
11. WIFI BUTTON
12. LIGHT BUTTON

Getting to know the display icons

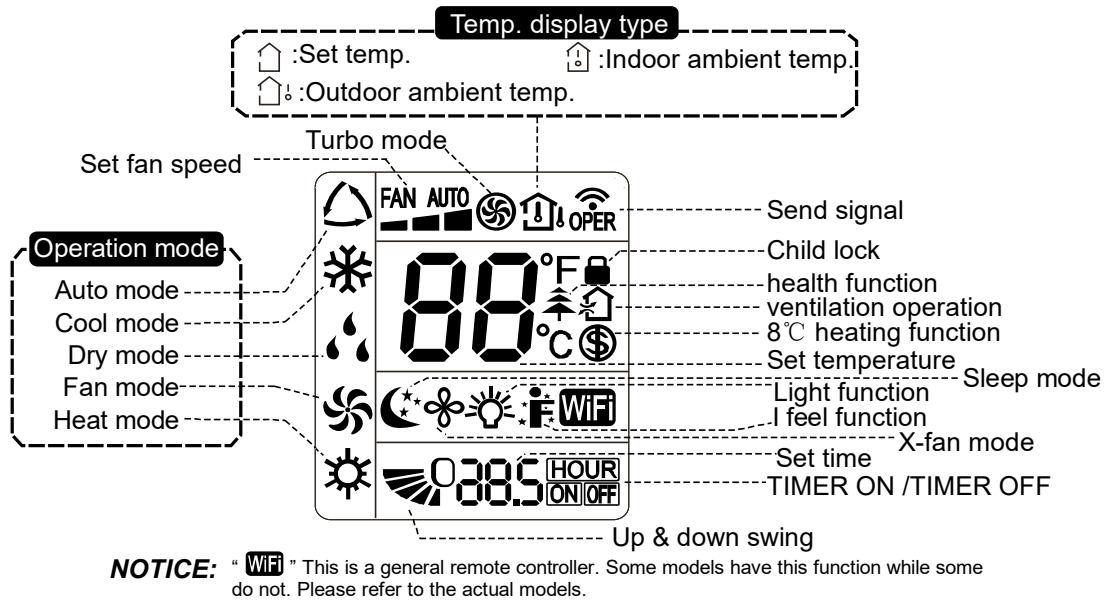

Getting to know the remote control buttons

N.B.:

- This is a general use remote controller, it can be used for the air conditioners with multifunction. For some functions, which the model doesn't have, if you press the corresponding button on the remote controller the unit will keep the original running status.
- Once connected to the power source, the air conditioner will make a sound. At this point the operation indicator "🔌" is ON (red indicator). You can now operate the air conditioner by using the remote controller.
- Pressing the ON/OFF button on the remote controller, the signal icon "📶" on the display of remote controller will blink once and the air conditioner will make a sound, this means that the signal has been sent to the air conditioner. In the ignition state, the display shows the corresponding function icons.
- Pressing once again the ON/OFF button to turn off the unit, the set temperature and the clock icon will be displayed on the display of remote controller (If timer on, timer off and light functions are set, the corresponding icons will be displayed on the display of remote controller at the same time);

1. On/Off button

Press this button to turn on or off the unit. The sleep function will deactivate when the unit is turned off.

2. Mode button

Each time you press this button, a mode is selected in a sequence that goes from: AUTO, COOL, DRY, FAN, and HEAT *, as the following:



- When you select automatic mode, the air conditioner will operate automatically according to the factory settings. The set temperature cannot be adjusted and will not be displayed. Pressing the "FAN" button will allow you to adjust the fan speed. Pressing the "SWING" button will allow you to adjust the angle of airflow.
- When you select cool mode, the air conditioner will run in cool mode. The ❄️ indicator will illuminate on the display. Press "▲" or "▼" to adjust the set temperature. Press the "FAN" button to adjust the fan speed. Pressing the "SWING" button will allow you to adjust the angle of airflow.

- When you select dry mode, the air conditioner will run at low speed in dry mode. The ☂ indicator will illuminate on the display. The fan speed cannot be adjusted in this mode. Pressing the "SWING" button will allow you to adjust the angle of airflow.
- When you select fan mode, the air conditioner will operate only the fan, blowing air without cooling or heating. All the indicators will switch off. Press the "FAN" button to adjust the fan speed. Pressing the "SWING" button will allow you to adjust the angle of airflow.
- When you select heat mode, the air conditioner will run in heat mode. The ☀ indicator will illuminate on the display. Press "▲" or "▼" to adjust the set temperature. Press the "FAN" button to adjust the fan speed. Pressing the "SWING" button will allow you to adjust the angle of airflow.

N.B.:

To prevent blasts of cold air from being blown into the room, there will be a delay of 1 – 5 minutes after selecting heat mode before operation begins. (The actual delay will depend on the indoor ambient temperature).

The temperature can be set between 16 – 30°C and four fan speeds are available: automatic, low, medium and high.

3. FAN button

Pressing this button will allow you to cycle through and set the fan speed: automatic (AUTO), low (▲), medium (▲▲) or high (▲▲▲). When turning on the unit, the AUTO ventilation speed is activated automatically. With automatic speed, the unit automatically selects the fan speed best suited according to the factory settings. In DRY mode (dehumidification), only the low ventilation speed can be set.

4. ▲/ ▼ button

Press "▲" or "▼" once to increase or decrease the set temperature by 1°C. (The temperature cannot be adjusted in automatic mode).

When setting the TIMER ON, TIMER OFF, press "▲" or "▼" to adjust the time.

5. SWING button – vertical oscillation

Press this button to set the swing angle (up/down). You can cycle through and set the fan's angle of airflow as shown below:

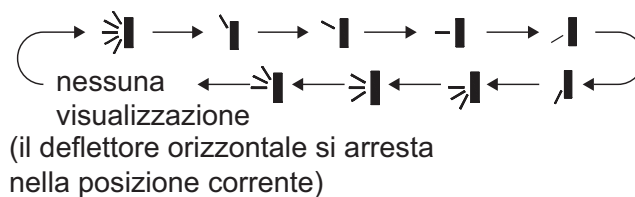

nessuna visualizzazione (il deflettore orizzontale si arresta nella posizione corrente)	no display (the horizontal flap stops in the current position)
---	--

6. SLEEP button

In cool, heat or dry mode, press this button to start the SLEEP function. The ☾ icon will appear on the remote control display. Press the button again to exit the SLEEP function. The ☾ icon will disappear from the display.

The temperature will increase or decrease by 2 degrees over two hours according to the function selected (cool/heat).

7. TEMP button

Pressing this button will allow you to display the set temperature, the indoor ambient temperature, or the outdoor ambient temperature on the indoor unit's display. You can cycle through the settings on the remote control display as shown below:

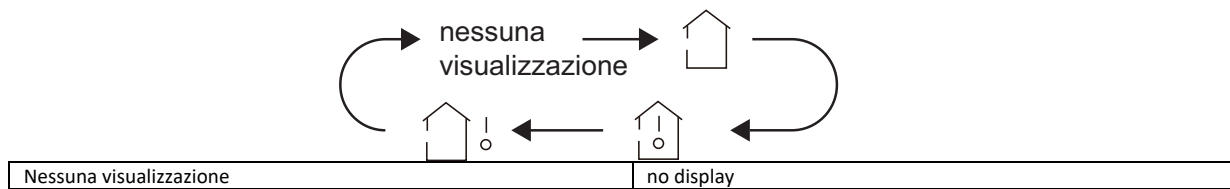

- When you select or “no display” with the remote control, the set temperature will appear on the indoor unit's display.
- When you select with the remote control, the indoor ambient temperature will appear on the indoor unit's display.
- When you select with the remote control, the outdoor ambient temperature will appear on the indoor unit's display.

N.B.:

- It is not possible to display the outdoor ambient temperature on all models. The indoor unit will receive the signal but will display the set temperature.
- The set temperature will appear on the unit's display on start-up, if enabled to do so.
- When you select to display the indoor or outdoor ambient temperature, the indoor unit will display the corresponding temperature for three to five seconds, after which it will automatically revert to displaying the set temperature.

8. TURBO button

In cool/heat mode, press this button to switch to rapid cool/heat mode. The icon will appear on the remote-control display. Press this button again to exit the TURBO function. The icon will disappear from the display.

9. I FEEL button

Press this button to start the I FEEL function. The icon will appear on the remote control display. When you select this function, the remote control will send the detected ambient temperature to the indoor unit, which will then adjust its operation automatically based on the difference between the detected temperature and the set temperature.

Press the button again to exit the I FEEL function. The icon will disappear from the display.

The remote control should be positioned near the user when this function is selected. The remote control should not be placed anywhere high or low temperatures may occur to avoid inaccurate ambient temperature detection.

10. TIMER ON/OFF button

On a working unit, press this button to set the unit's power off time. When the unit is off, press this button to set the unit's power-up time. By pressing this button, the HOUR ON or HOUR OFF indicator starts blinking: if you press "▲" or "▼" buttons you can set the time (from 0.5 to 24) to switch the unit off or on. Hold down the button "▲" or "▼" for 2 seconds to quickly change the time until the desired time is reached. Press the TIMER button to confirm the TIMER settings and the HOUR ON or HOUR OFF indication will stop blinking.

If the “HOUR” message flashes but does not follow any setting, it will stop flashing after 5 seconds. If the TIMER ON or OFF function is activated, press the TIMER button to cancel the setting.

11. Wi-Fi button

Press this button to start the Wi-Fi function. When the Wi-Fi function is active, the "Wi-Fi" icon will appear on the remote control display. When the remote control is off, press and hold the "Mode" button and the "Wi-Fi" button simultaneously for 1 sec to return to the factory settings.

12. LIGHT button

Press this button to turn off the indoor unit's display light. The icon will disappear from the remote control display.

Press this button again to turn on the display light. The icon will appear on the display.

Getting to know the button combination functions

Energy saving function

In cool mode, press the TEMP and CLOCK buttons simultaneously to start or stop the energy saving function. When you start the energy saving function, "SE" will appear on the remote control display and the air conditioner will automatically adjust the set temperature according to the factory settings to achieve the best energy-saving effect. Press TEMP and CLOCK again simultaneously to exit the energy saving function.

N.B.:

- When the energy saving function is enabled, the fan will operate at the default automatic speed and cannot be adjusted.
- When the energy saving function is enabled, the set temperature cannot be adjusted. The remote control will not send a signal to the unit when the TURBO button is pressed.
- The SLEEP and energy saving functions cannot operate simultaneously. If the energy saving function was set in cool mode, press the SLEEP button to cancel it. If the SLEEP function was set in cool mode, start the energy saving function to cancel it.



8°C heating function

In cool mode, press the TEMP and CLOCK buttons simultaneously to start or stop the 8°C heating function. When this function is enabled,  and 8°C will appear on the remote control display and the air conditioner will continue to operate at 8°C. Press TEMP and CLOCK again simultaneously to exit the 8°C heating function.

N.B.:

- When the 8°C heating function is enabled, the fan will operate at the default automatic speed and cannot be adjusted. The remote control will not send a signal to the unit when the TURBO button is pressed.
- The SLEEP and 8°C heating functions cannot operate simultaneously. If the 8°C heating function was set in cool mode, pressing the SLEEP button will cancel it. If the SLEEP function was set in cool mode, starting the 8°C heating function will cancel it.
- When the temperature display is in °F, the remote control will show that the unit is operating at 46°F.

Remote control button lock function

Press "▲" and "▼" simultaneously to enable or disable the remote control button lock function. When this function is enabled,  will appear on the remote control display. If you attempt to operate the remote control, the  icon will flash three times and no signal will be sent to the unit.

Switching temperature display

In OFF mode, press the "▼" and "MODE" buttons simultaneously to switch from a temperature display in °C to °F.

Operating guide

General operations

1. When you connect the power, press the "ON/OFF" button on the remote control to turn the air conditioner on.
2. Press the MODE button to select the desired operating mode: AUTO, COOL, DRY, FAN or HEAT.
3. Press "▲" or "▼" to adjust the desired temperature. (The temperature cannot be adjusted in automatic mode.)
4. Press the "FAN" button to set the desired fan speed: automatic, low, medium or high.
5. Press the "SWING" button to adjust the fan's angle of airflow.

Optional Operations

1. Press the SLEEP button to set the function sleep
2. Press the timer ON/ timer OFF button to set the timer ON or timer OFF
3. Press the LIGHT button to check the switching on or off of the different parts of the display (this function may not be possible for some units)
4. Press the TURBO button to activate or deactivate the function TURBO.

Replacing the remote-control batteries

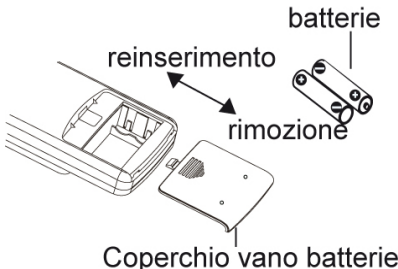
<ol style="list-style-type: none"> 1. Remove the battery compartment cover, marked with  (see image to right), by sliding it in the direction of the arrow. 2. Use only two AAA – LR03 1.5V batteries. Make sure the + and – ends are facing the correct direction. 3. Slide the battery compartment cover back into place. 	
---	--

batterie	batteries
reinsierimento	close
rimozione	open
Coperchio vano batterie	battery compartment cover

N.B.:

- When the unit is operating, point the remote control's signal transmitter at the indoor unit's receiver.
- The distance between the transmitter and the receiver must not exceed 8 metres and should remain free of obstacles.
- If the room contains a fluorescent light or cordless telephone, signal interference can occur.
- When the remote control is not used for a month or more, remove the batteries.
- Use batteries of the same type when replacing the batteries, as necessary.
- If the icons on the remote control display are blurred or not visible, replace the batteries.



INFORMATION FOR THE CORRECT DISPOSAL OF BATTERIES IN ACCORDANCE WITH EUROPEAN DIRECTIVE 2006/66/EC

Replace batteries when they are depleted. At the end of their life, batteries must be disposed of separately from unsorted waste. They must be taken to designated recycling centres or returned to a retailer providing this service. Separate disposal of batteries helps to reduce the potential harmful effects on the environment and human health caused by their improper disposal and also enables the recovery and recycling of component materials, saving significant energy and resources. The requirement for separate disposal is indicated by the crossed-out wheeled bin label affixed to the appliance. Illegal disposal of the product by the user is subject to administrative penalties as per current regulations.

WIFI GUIDE (ONLY FOR AIR CONDITIONERS WITH WIFI)

How to set and operate the air conditioner with Wifi

1. Make sure that the device (smartphone or Tablet) used is equipped with a standard version of Android (version 4.4 or higher) and iOS (iOS7.0 or higher) as the operating system. For more details refer to the App.
2. Units can be connected and controlled only via Wi-Fi network or via Hotspot function.
3. Routers with WEP encryption are not supported.
4. The application interface is universal for all products and many features may not match for all units. It may vary depending on the operating system used or the update in use. Refer to the current version.
5. If the access protection on your Router is active in the "MAC Filter" / "MAC address filter" item, enable the access to the network of the MAC address of the device.

Installation and use instruction

1. Frame the QR Code using a *QR Code Reader*



or search for the "EWPE SMART" application in the app store



download and install the application.

Install the App by referring to its guide. Once the installation is complete, the icon appears on the smartphone's home page.



NB:

Before starting any procedure, disconnect the power supply from the product, allow a few minutes to pass and reconnect it.

2. Registration and access.

After installing the application, open "EWPE SMART" and click Sign up to register.

PLEASE NOTE:

- USERNAME: must be UNIQUE, composed of name + number, without spaces (eg **Rossi57**)
- Personal email: if already registered, retrieve Username / Password. It is not possible to create another account with the same mail.
- PASSWORD: must have at least one capital letter, symbols or special characters (- ;, etc.) and numbers.
- Repeat PASSWORD written above
- EUROPE country

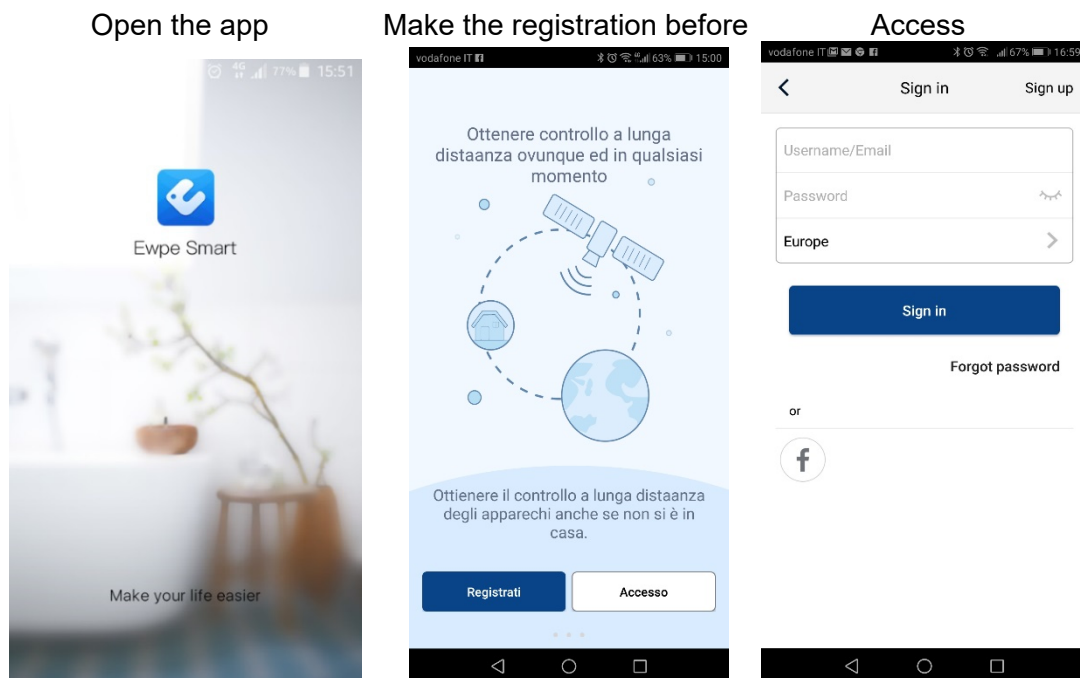

3. Adding units

Clicking on the icon of the little man opens a menu that includes, among other things, the "Help" function.

Follow the instructions that appear on your device to add the unit. or add a new unit, press + in the upper right corner of the homepage.

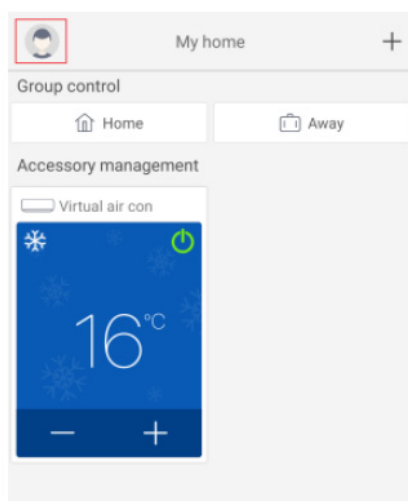

A menu appears with all the categories of devices that can be connected.

Select the relevant type:

In case of **residential air conditioner**: the first box on left

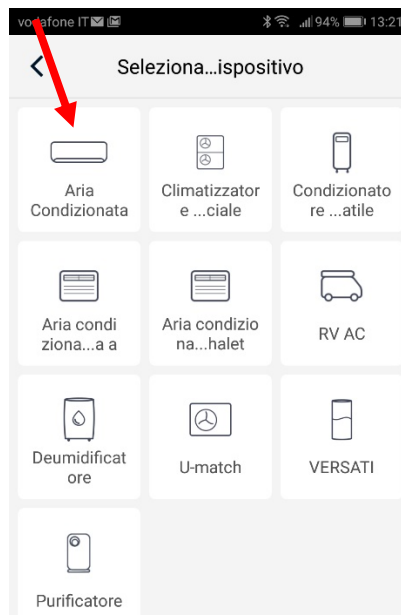

After choosing the category of interest, proceed with the reset of the unit.

Different unit reset systems can be chosen depending on the type of unit / system and remote control (with or without wifi key).

Follow step by step the operative instructions depending on the selected reset system.



After performing the reset following the instructions, click on Next to automatically add the unit (it's necessary to enter Wi-Fi password).

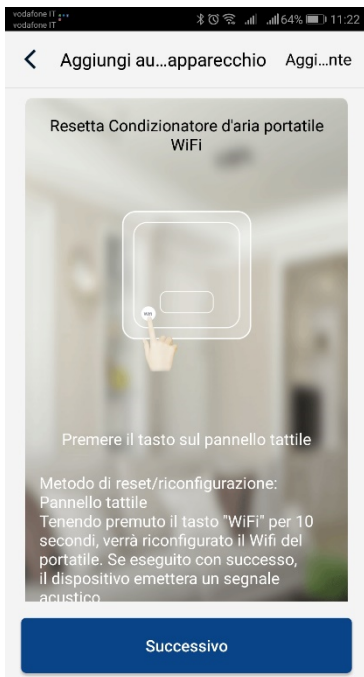

WIRE CONTROL OR PORTABLE AIR CONDITIONER (CONTROL PANEL RESET)
Press the button on the touch panel.
With the unit off, press and hold the "Wifi" button for 10 seconds. When the unit beeps, it means the reset has been successful.
NB:
The configuration must be done within 2 minutes. If it does not happen within 2 minutes, repeat the reset operation.

REMOTE CONTROL WITH WIFI BUTTON
Direct the remote control towards the unit.
With the remote control off, press the "Mode" + "Wifi" buttons simultaneously for 1 second.
When the unit beeps, it means that the reset has been successful.
NB:
The configuration must be done within 2 minutes. If it does not happen within 2 minutes, repeat the reset operation..

REMOTE CONTROL WITHOUT WIFI BUTTON (MODE and TURBO)
Direct the remote control towards the unit.
Press the "Mode" + "Turbo" buttons simultaneously for 10 seconds. After the unit has twice produced an acoustic signal, this will mean that the reset has been successful.
NB:
The configuration must be done within 2 minutes. If it does not happen within 2 minutes, repeat the reset operation

Alternatively, after setting and resetting the air conditioner, click on *Add appliance manually* in the upper right corner to select the Wi-Fi network to associate.

Select the desired network and continue the configuration.

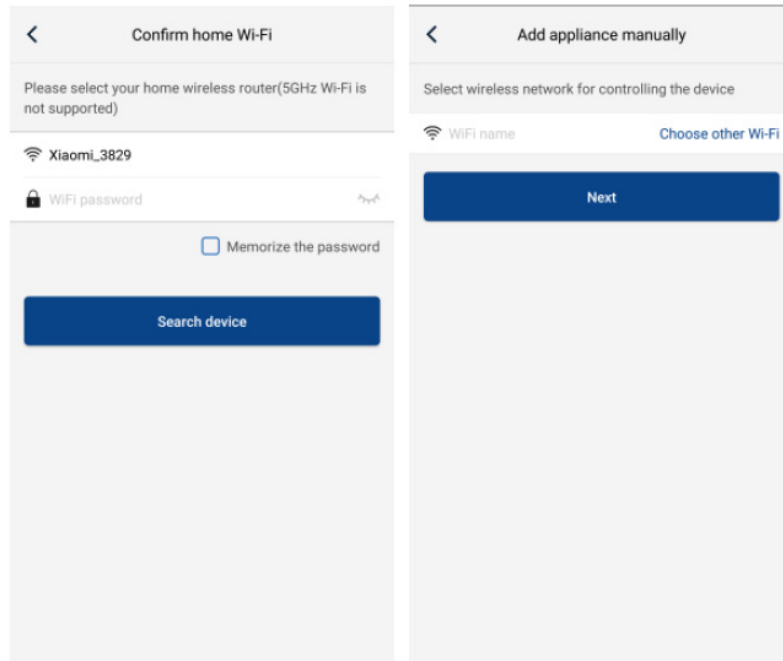

After performing the electrical reset of the unit and entering the information, perform a search for the unit (Search appliance) and continue the configuration.

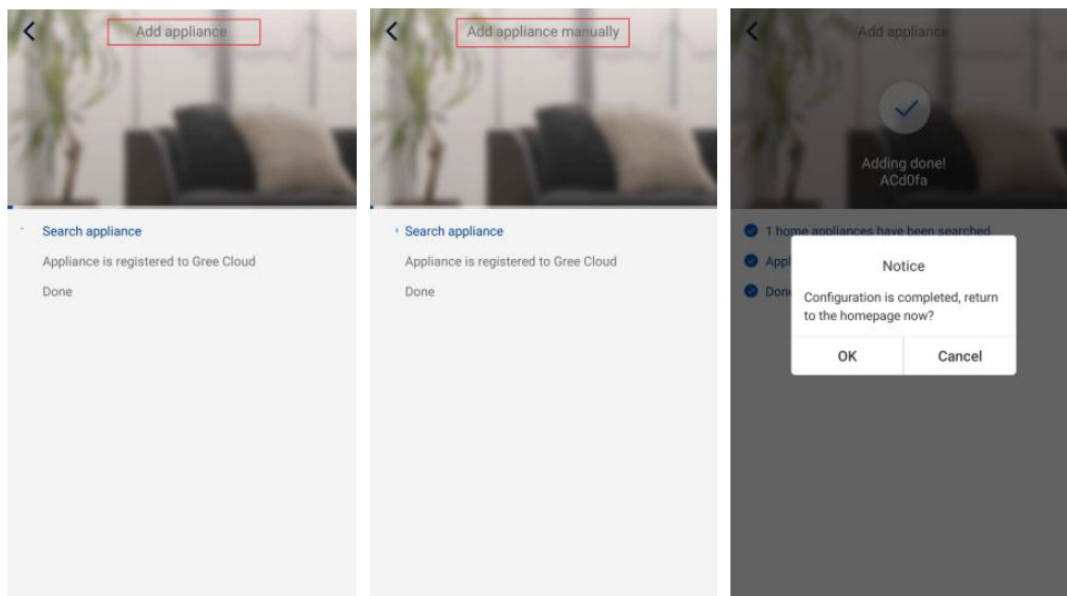

Configuration of the main functions

In the Homepage click on the device you wish to control and access the operating interface of it.

1. **Select, operating mode, temperature and fan speed.**
 - **Mode**

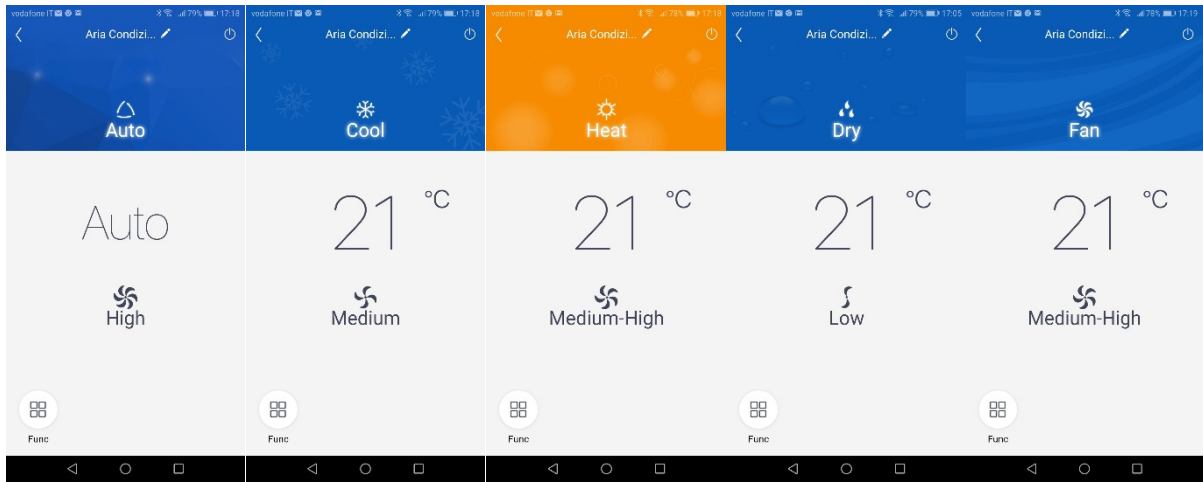

2. Temperature for each mode: just slide your finger on the indicated temperature

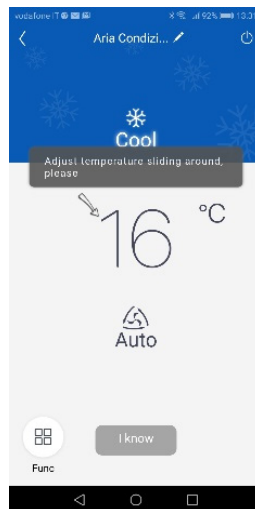

3. Ventilation speed for each mode: just slide your finger on the fan symbol (the adjustment possibilities vary depending on the mode)

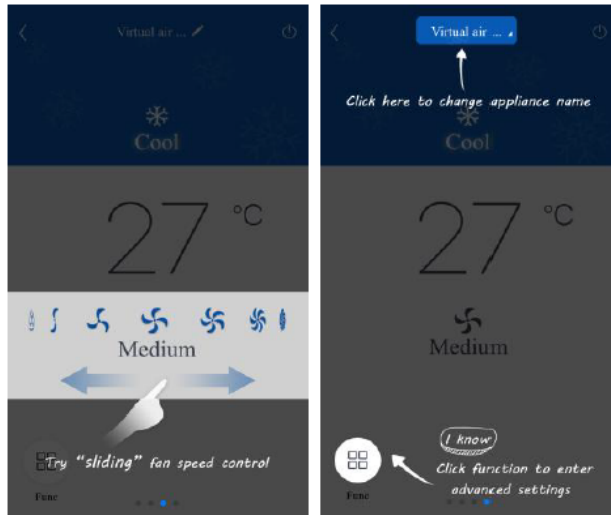

4. Set advanced functions

Click Function (Func) in the lower left corner of the interface to enter the advanced settings.

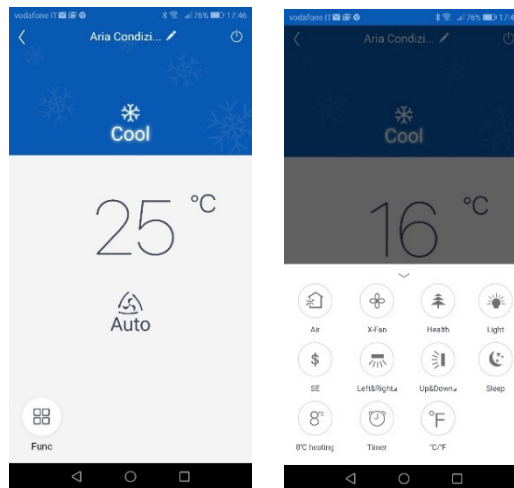

X-FAN function

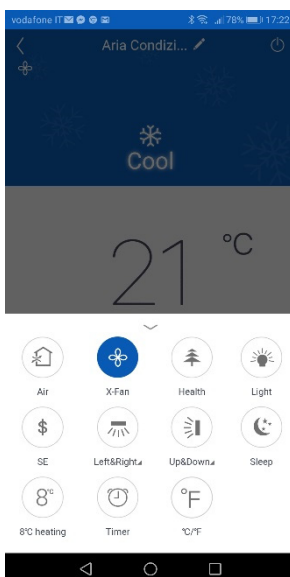

Vertical flap swinging

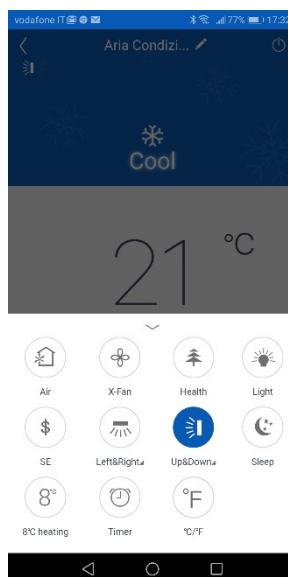

Horizontal flap swinging
(if available)

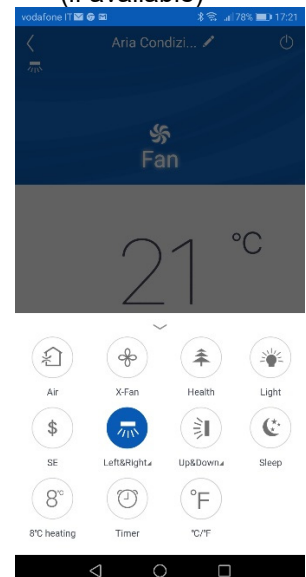

Sleep function

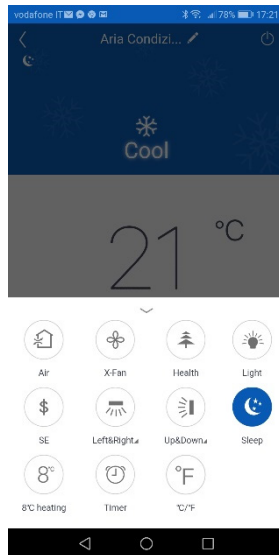

Light on indoor unit display

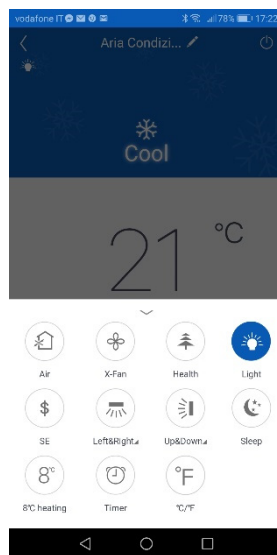

Temperature unit conversion

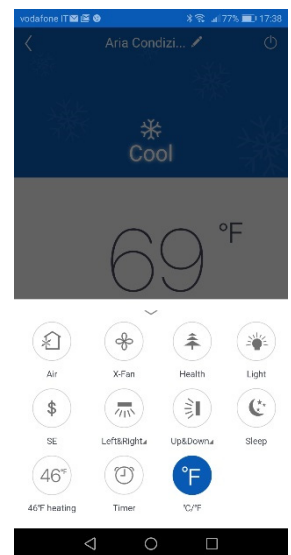

Swing setting

Click Up & down swing to turn the swing function on or off. Click the arrow in the lower right corner of the icon to go to the next screen and set the swing level.

List of Preselections

Click Timer. Then click + and make adjustments.

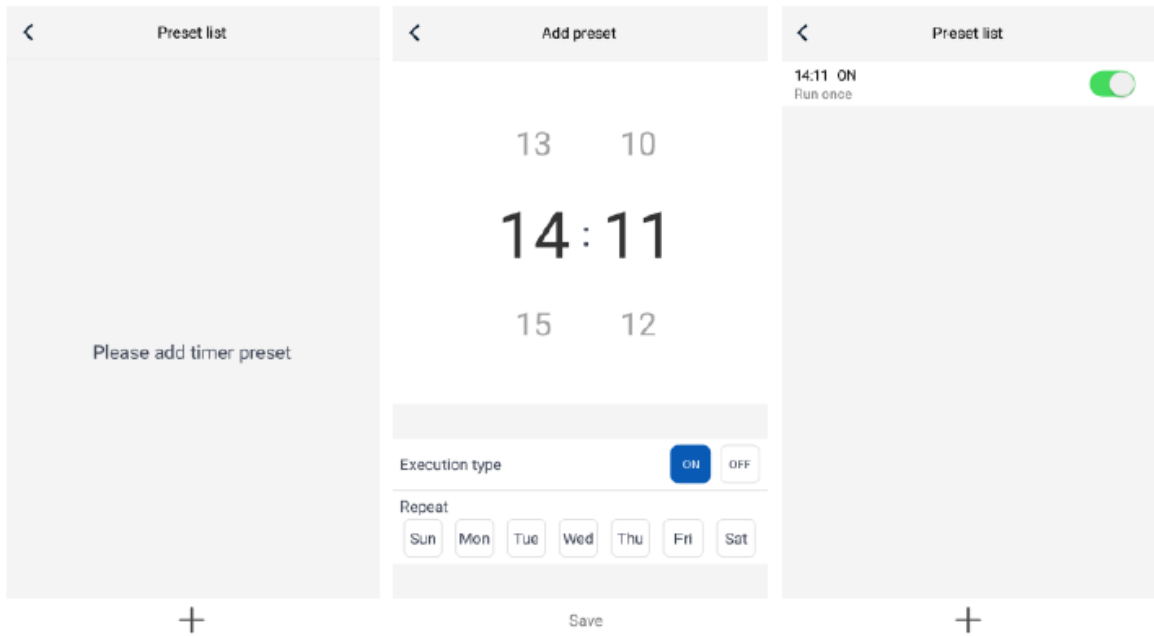

Other functions

1. Homepage menu

Click on the profile picture in the upper left corner of the homepage and set each menu function.

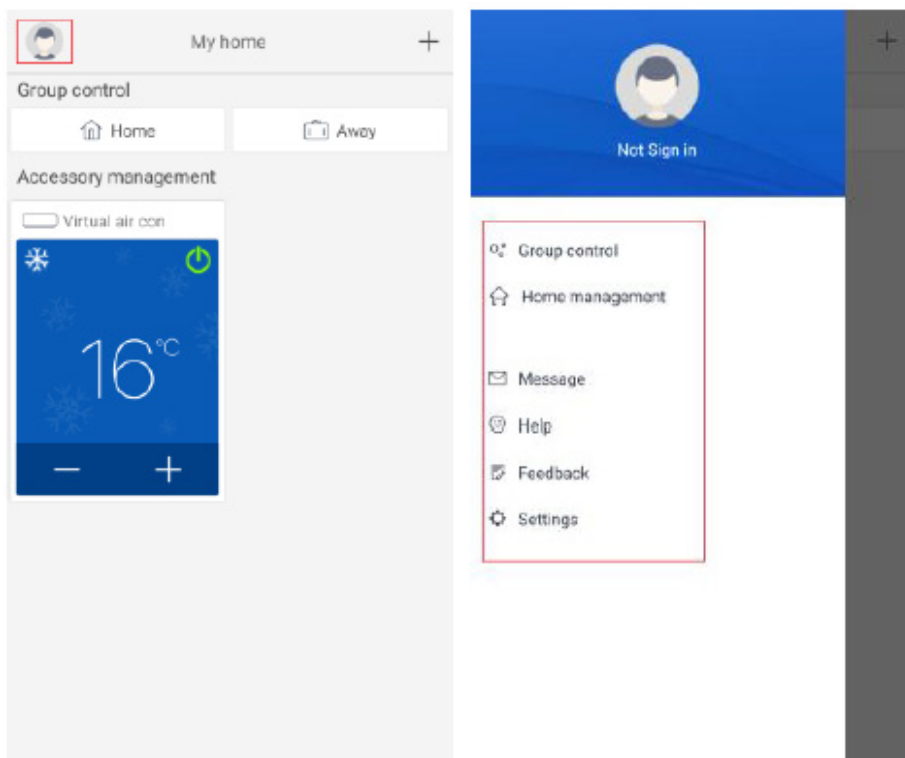

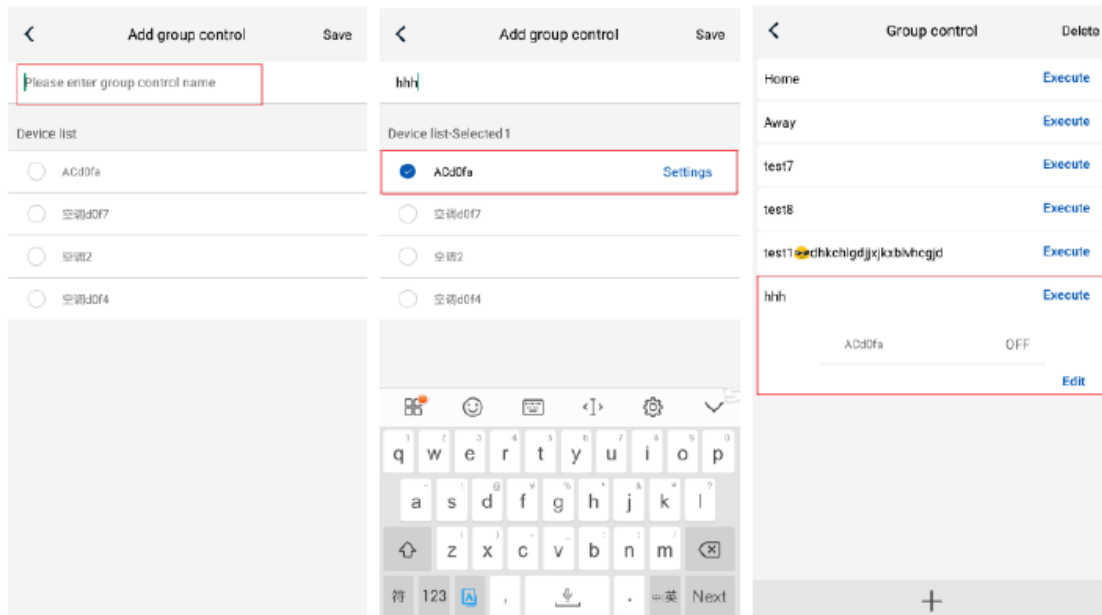

2. Group Control

Click Group Control to use the present devices (Ex. Change the group name to "hhh" and set up the devices in the group list). When this group is working you can change the settings of the whole group.

3. Home Management

Click Home Management to create or manage a "family system". You can add new members to the family system of the registered account.

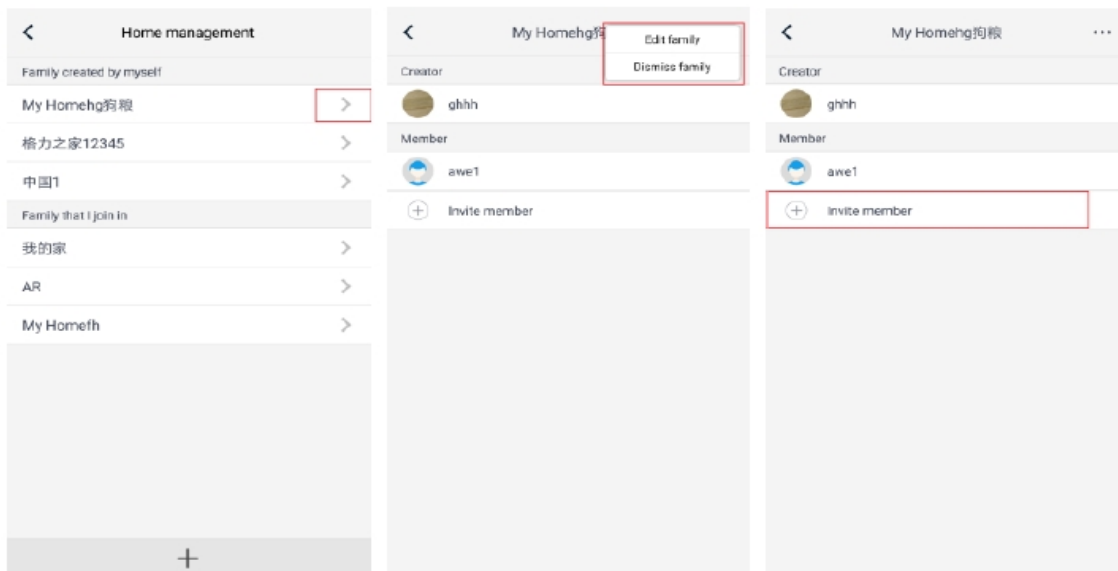

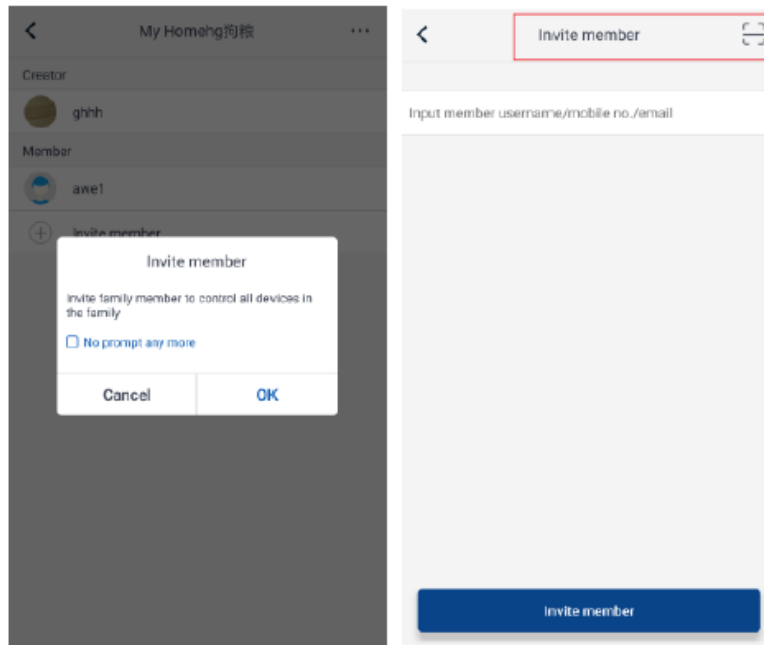

4. Help

Press Help to view the instructions for **EWPE SMART APP**.

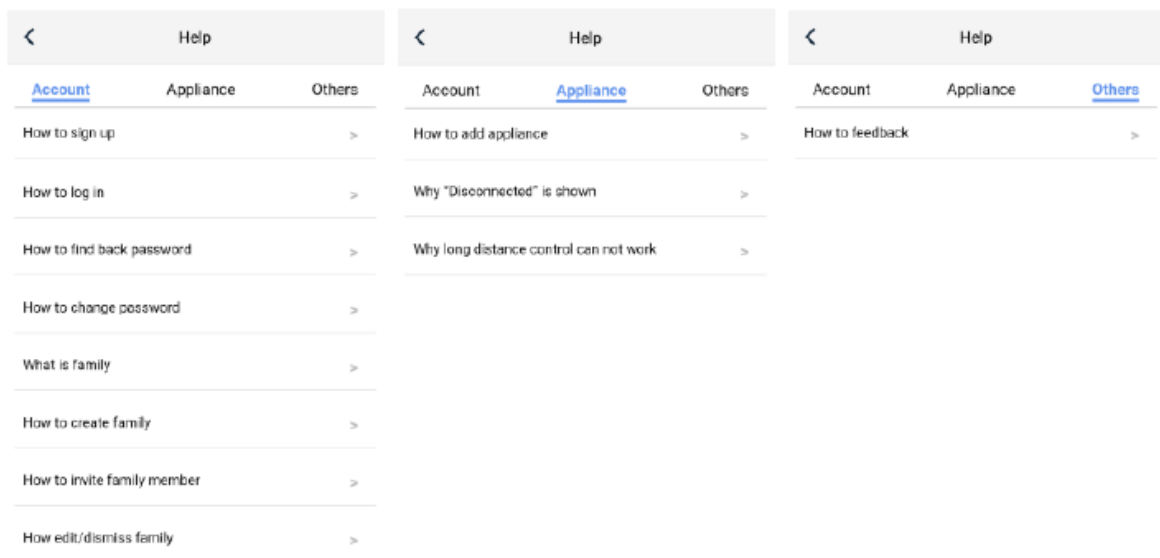

5. Feedback

Click Feedback to send a feedback on the product.

6. How to reset the air conditioner WiFi module:

Turn off the unit with the remote control and disconnect the air conditioner power for at least 10 seconds. Reconnect the power supply. After 1 minute, press the "WiFi" and "Mode" buttons simultaneously. If the air conditioner beeps, it means that the WiFi module has been reset correctly.

Attention: The configuration is carried out within 2 minutes. If it does not happen within 2 minutes, repeat the reset operation.

Analysis of common network setting errors:

If the short distance control does not work, perform the checks specified below:

- Make sure the air conditioner power is connected.
- Make sure that the air conditioners WiFi function is normally active.
- Make sure your phone's WiFi selects the corresponding air conditioner.
- Reset with the remote control and restart the setting from step 3.

It is important to remember what is listed below.

1. The WiFi function of the air conditioner takes about 1 minute to start.
2. The air conditioner is equipped with memory function.

Emergency operation

In the event of loss or failure of the remote control, use the emergency button located under the indoor unit's front panel to turn the air conditioner on or off.

The unit will operate in automatic mode on start-up.

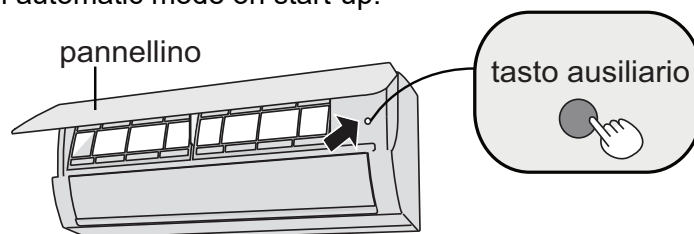

pannellino	panel
Tasto ausiliario	auxiliary button

MAINTENANCE

Care and cleaning

N.B.:

Disconnect the power before servicing or cleaning the unit.

Cleaning the casing of the indoor unit

Use a soft, damp cloth to clean the outer surface of the unit.

Do not use water that is too hot, solvents, petrol or other aggressive chemical compounds, talcum powder or brushes. These may damage the colour or surface of the casing.

To remove stains, use warm water with a little neutral detergent.

Do not pour water onto the air conditioner to clean it. This may damage the internal components or cause a short circuit.

N.B.: Do not remove the panel when cleaning the unit.

Cleaning the filters

Open the panel

Lift the front panel of the indoor unit, as shown.



Remove the filters

Remove the filters by lifting one of the bottom corners and pulling them downwards, as shown.

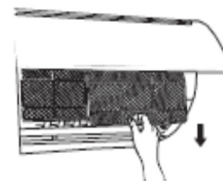

Clean the filters

- Use a vacuum cleaner to clean the filters.
- If they are very dirty, use water (below 45°C) and leave to dry in a cool, dark place.



Refit the filters

Refit the filters and close the front panel.



N.B.:

- The filters should be cleaned every three months, or more frequently if the room is very dusty.
WARNING!
When you remove the filters, avoid contact with the heat exchanger (there is a risk of cuts or abrasion).
- Do not use a hairdryer to dry the filters; the heat can cause damage and warping.

Before-use checks

1. Check that the air inlet and outlet are free of obstructions.
2. Check that the circuit breaker, plug and socket are in good working order.
3. Check that the filters are clean.
4. Check that the outdoor unit's support bracket is not damaged or corroded. If it is, contact the service centre.
5. Check that the piping is not damaged.

After-use checks

1. Disconnect the power supply.
2. Clean the indoor unit's panel and filters.
3. Check that the outdoor unit's support bracket is not damaged or corroded. If it is, contact the service centre.

N.B.

1. Many packaging materials are recyclable materials. Please dispose of them in the appropriate recycling unit.
2. If you want to remove the air conditioner, please contact your local dealer or local service provider for the correct disposal method.

TROUBLESHOOTING

Possible faults and solutions

WARNING

Do not attempt to repair the unit yourself. Improper repair can cause electric shocks or fire. Disconnect the unit from the power supply before contacting your local Technical Service Centre. Carry out the following checks before contacting your Technical Service Centre:

Fault	Check	Solution
The indoor unit does not receive the signal from remote control or the remote control does not seem to be working	Is there noticeable interference (e.g. static electricity, stable voltage)?	Pull out the plug. After about 3 minutes reinsert the plug and restart the unit.
	Is the remote control within the signal reception range? Are there any obstacles between the remote control and the receiver?	The maximum signal reception distance is 8 m. The remote control will not work beyond this distance. Remove the obstacles.
	Is the remote control pointed at the receiver?	Point the remote control at the receiver on the indoor unit.
	Is the remote control's sensitivity low? Are icons blurred or missing?	Check the batteries. If the batteries are very low, replace them.
	Do icons fail to appear on the display when you operate the remote control?	Check if the remote control is damaged. If it is, replace it.
	Is there a fluorescent light in the room?	Position the remote control next to the indoor unit. Turn off the fluorescent light and try again.
No air comes out of the indoor unit	Is the indoor unit's air inlet or outlet blocked?	Remove the obstruction.
	In heat mode, has the indoor temperature reached the set temperature?	Once the set temperature has been reached, the indoor unit will stop blowing out air.
	Has heat mode only recently been selected?	To prevent blasts of cold air from being blown out, there will be a delay of several minutes before operation begins (this is normal).
The air conditioner is not working	Is there a power cut?	Wait for the power to be restored.
	Has the plug come loose?	Reinsert the plug.
	Has the circuit breaker tripped or has the fuse blown?	Have the circuit breaker or fuse replaced by a qualified technician.
	Is the wiring faulty?	Have it replaced by a qualified technician.
	Was the unit restarted immediately after shutdown?	Wait 3 minutes and then restart the unit.
	Is the setting on the remote control correct?	Reset the function.
The indoor unit's air outlet produces a mist	Is the indoor temperature and humidity high?	Indoor air cools rapidly. Wait for the indoor temperature and humidity to fall and the mist to disappear.
The set temperature cannot be adjusted	Is the unit operating in automatic mode?	The temperature cannot be adjusted in automatic mode. Change the operating mode if you want to adjust the temperature.
	Does the desired temperature fall outside the available temperature range?	The available temperature range is: 16 – 30°C.
The desired level of heating/cooling cannot be achieved	Is the voltage too low?	Wait for the voltage to return to normal.
	Is the filter dirty?	Clean the filter.
	Does the set temperature fall within the available temperature range?	Adjust the temperature to within the available range.
	Are there any doors or windows open?	Close any doors and windows.
The unit is emitting unpleasant smells	Is there an odour source (e.g. furniture, cigarettes, etc.)?	Eliminate the odour source. Clean the filter.
The air conditioner turns on suddenly	Are there any sources of interference (e.g. lightning, wireless devices, etc.)?	Disconnect the power supply and then reconnect it. Turn the unit on again.
The outdoor unit produces steam	Has heat mode been selected?	Steam production when defrosting in heat mode is a normal phenomenon.

Sound of running water	Has the air conditioner recently been turned on or off?	The noise is produced by the refrigerant flowing inside the unit (normal phenomenon).
Creaking/cracking noises	Has the air conditioner recently been turned on or off?	It is the sound of the friction caused by the expansion and/or contraction of the panel or other parts due to temperature changes.

Analysing faults and solutions

Error codes

In the event of a fault, the temperature indicator on the indoor unit will flash to display the corresponding error code. Refer to the following list to identify the error code.

Error code	Faults and solutions
E5	Can be eliminated by turning the unit off and on again. Otherwise, contact a qualified technician for assistance.
E6	Can be eliminated by turning the unit off and on again. Otherwise, contact a qualified technician for assistance.
U8	Can be eliminated by turning the unit off and on again. Otherwise, contact a qualified technician for assistance.
E8	Can be eliminated by turning the unit off and on again. Otherwise, contact a qualified technician for assistance.
C5	Contact a qualified technician for assistance.
F0	Contact a qualified technician for assistance.
F1	Contact a qualified technician for assistance.
F2	Contact a qualified technician for assistance.
H3	It can be eliminated switching off the unit and switching it back on. If this doesn't work contact a qualified technician to assist.
H6	It can be eliminated switching off the unit and switching it back on. If this doesn't work contact a qualified technician to assist.

N.B.: In the event of other error codes, contact a qualified technician for assistance.

Warning

If you experience any of the following problems, turn the air conditioner off and immediately disconnect the power. Then contact your local Technical Service Centre.

- The power cable is damaged or has overheated.
- The unit makes an unusual noise during operation.
- The circuit breaker keeps tripping.
- The air conditioner emits a burning smell.
- The indoor unit is leaking.
- Do not attempt to repair or reinstall the air conditioner yourself.
- If the air conditioner is operated in abnormal conditions, malfunction, electric shock or fire may result.

INSTALLATION INSTRUCTIONS

Installation diagrams

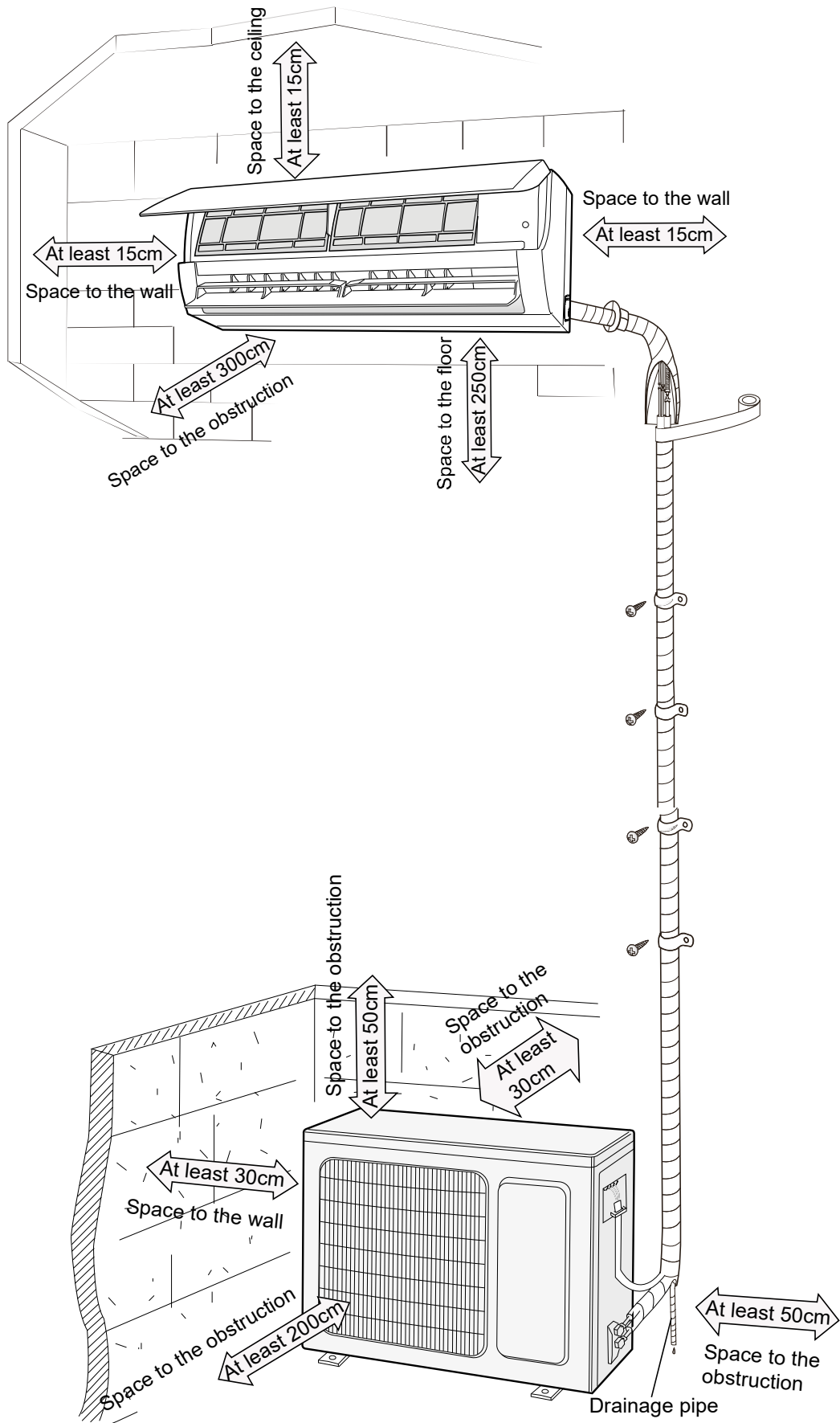

INSTALLATION WARNINGS

WARNING: Make sure that the power supply is disconnected before carrying out any work on the unit.

WARNING: Wear appropriate personal protective equipment before carrying out any work on the unit.

WARNING: The appliance must be reinstalled in accordance with national system regulations.

WARNING: Wiring and installation must only be performed by a qualified technician trained to install, modify, extend and service the unit and perform safety and functionality tests.

WARNING: Install a device, master switch or electric plug that will allow all the power from the appliance to be switched off.

The following information is essential for correct unit installation. However, the installer should use his or her experience to install the unit according to specific requirements.

Do not install the unit in locations where there are flammable gases or acid or alkaline substances that may irreparably damage the copper-aluminium heat exchangers or internal plastic components.

Do not install the unit in offices or kitchens where oil vapours mixed with treated air may settle on the exchange coils, reducing performance, or on the unit's internal parts, damaging the plastic components.

ATTENTION: For the connection between the units, use only annealed and deoxidized copper pipe for conditioning and refrigeration and insulated with expanded polyethylene of min. 8 mm.

Choosing a location for installation

Essential requirements	Indoor unit
<p>Do not install the unit in the following locations. Otherwise, a fault may occur.</p> <ol style="list-style-type: none"> Locations with extreme heat sources or flammable or explosive gases or vapours. Locations with high-frequency devices (e.g. welding machines, medical equipment). Locations close to coastal areas. Locations with oils or fumes in the air. Locations with sulphide gas. Other locations that have special conditions. <p>Do not operate the unit in the immediate vicinity of laundrettes, bathtubs, showers or swimming pools.</p>	<ol style="list-style-type: none"> There should be no obstructions near the air inlet or outlet. Choose a location where the condensate can drain out easily without causing a nuisance. Choose a convenient location to connect the outdoor unit to the power outlet. Choose a location out of the reach of children. The site should be strong and solid enough to support the weight of the indoor unit and prevent noise or vibration. The unit should be installed 2.5 m from the floor. Do not install the indoor unit directly above electrical equipment. Try to keep a certain distance from fluorescent lights.
Outdoor unit	<ol style="list-style-type: none"> Choose a location where the noise and airflow produced by the outdoor unit will not annoy neighbours. The location should be well ventilated and dry; the outdoor unit must not be exposed to direct sunlight or strong winds. The site should be able to support the weight of the outdoor unit. Check that the installation complies with the requirements of the dimensional drawing for installation. Choose a location out of the reach of children and away from animals or plants. If this is not possible, install safety fencing.

Electrical connection requirements

Safety precautions

1. Electrical safety standards must be met when installing the unit.
2. Use a power supply circuit and circuit breaker that comply with local safety regulations.
3. Make sure that the power supply matches the requirements of the air conditioner. An unstable power supply or incorrect wiring may result in a fault. Install suitable power cables before switching on the air conditioner.
4. Correctly connect the live, neutral and earth wires to the power outlet.
5. Disconnect the power supply before carrying out any work on the electrical circuit or carrying out any safety work. For models with a plug, make sure the plug is easily accessible after installation.
6. Do not connect the power before installation is complete.
7. Do not use the appliance if the power cable or plug are damaged. If the power cable is damaged it must be replaced by the manufacturer, retailer or other qualified person to avoid a hazard.
8. Since the temperature of the cooling circuit is high, keep the interconnecting cable away from the copper pipe.
9. The unit must be installed in accordance with national wiring regulations.
10. Installation must only be performed by trained individuals in accordance with regulations.



The unit is charged with a slightly inflammable refrigerant, R32. Improper handling of this gas may expose people and materials to serious damage. More details on this refrigerant are given at the beginning of this manual.

Earthing

1. The air conditioner is a Class I appliance. The unit must be earthed with an appropriate device by a qualified technician. Ensure the unit is always properly earthed. Otherwise electric shock may result.
2. The green-yellow wire of the air conditioner is the earthing wire and may not be used for other purposes.
3. The earth resistance must meet national standards for electrical safety.
4. The unit must be positioned so that the plug is accessible.
5. An all-pole isolating switch with a minimum contact gap of 3mm in each pole must be connected to the fixed cable.

INSTALLATION

Indoor unit installation

Step one: choose of the position

Decide where to install the unit based on room design, architectural limitations and customer requirements. Check that in the selected location the unit can be accessed for servicing and cleaning the filters. To install, use the installation plate as a template to identify the exact position for the wall plugs and through-hole in the wall. The plastic casing has stoppers which if necessary can be removed to route the refrigerant lines and cables. When operating in cool or dry mode, the moisture in the air condenses on the coil of the indoor unit, collects in the basin and drains out through the special rubber hose. The hose must be connected to a pipe with a suitable gradient, ensuring no unnecessary bends are created. Do not run siphons and do not immerse in water.

Step two: mount the wall-installation plate

1. Position the installation plate on the wall. Use a level to position it horizontally and mark the holes for the bolts on the wall.
2. Drill the holes for the screws in the wall with a hammer drill (the drill bit must match the plastic wall plug). Then insert the wall plugs into the holes.
3. Secure the plate to the wall with the self-tapping screws (ST4.2X25TA). Check it is securely attached by pulling on the bracket. If a plastic wall plug is loose, drill another hole nearby with the hammer drill.

Step three: drill the hole for the piping

Select the position for the piping hole according to the direction of the outlet pipe. The piping hole must be slightly lower than the wall-installation frame, as shown below.

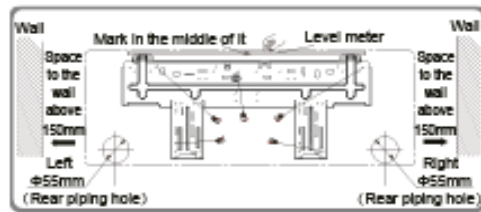
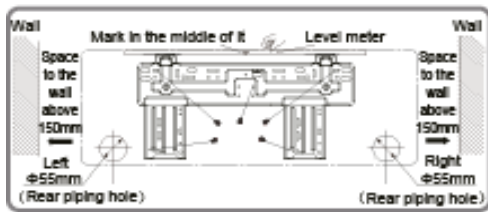

Drill a piping hole of diameter $\Phi 55$ at the chosen location for the outlet pipe. To allow for proper drainage, the piping hole in the wall must slant slightly downwards to the outdoor side, with a gradient of 5 – 10°.

N.B.:

- Take the necessary safety measures when drilling the hole and do not allow dust to enter.
- The plastic wall plugs are not supplied but must be purchased on site.

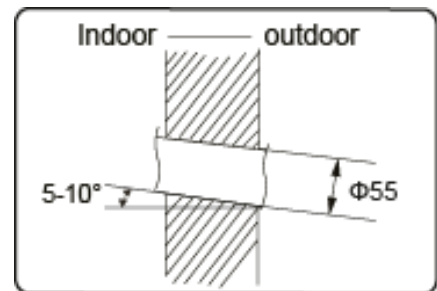

Step four: outlet pipe

The pipe can be brought out in various different directions: right, rear right, left or rear left.

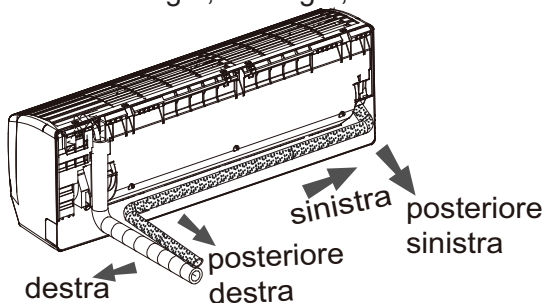

destra	right
posterioredestra	rear right
sinistra	left
posteriore sinistra	rear left

Once you have selected the direction of the outlet (left or right), drill the corresponding hole at the bottom.

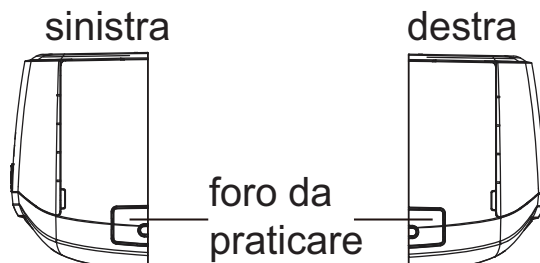

destra	right
foro da praticare	hole to be drilled
sinistra	left

Step five: connect the indoor unit pipe

1. Position the pipe joint in the corresponding bellmouth.
2. Pre-tighten the union nut by hand.
3. Adjust the torque according to the following table. Position the open-end spanner on the pipe joint and position the torque wrench on the union nut. Tighten the nut with the wrench.

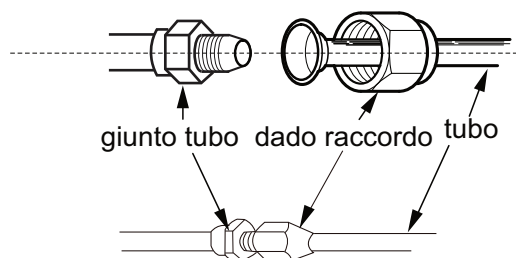

giunto	pipe
tubo	joint
dado	union
raccordo	nut

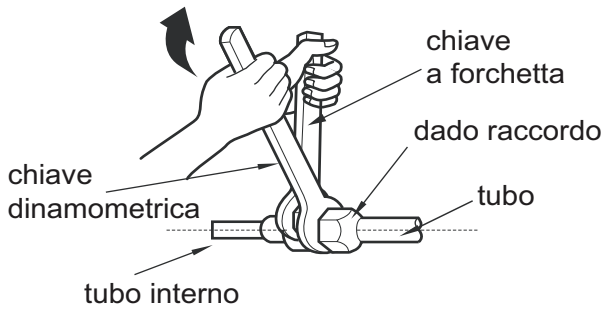

Hex nut diameter	Tightening torque (Nm)
Φ6.35	15 – 20
Φ9.52	30 – 40
Φ12.7	45 – 55
Φ15.88	60 – 65

chiave a forchetta	open-end spanner
Chiave dinamometrica	wrench
Tubo interno	inner pipe
dado raccordo	union nut
tubo	pipe

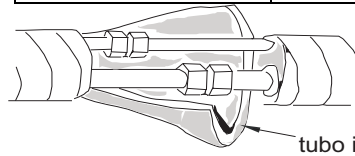

Tubo isolante	insulating tube
---------------	-----------------

Wrap the indoor pipe and the joint of the connecting pipe with an insulating tube. Then wrap with tape.

Step six: install the condensate drain pipe

1. Connect the drain pipe to the outlet pipe of the indoor unit.
2. Bind the joint with tape.

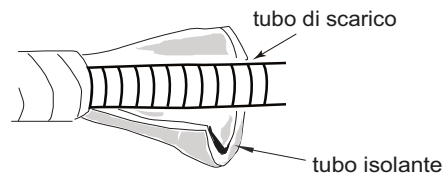
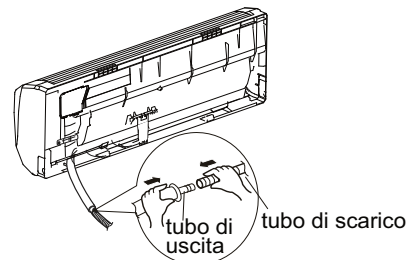
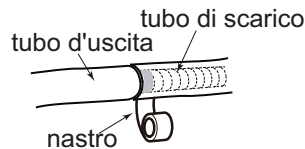

Tubo isolante	insulating tube
tubo di uscita	outlet pipe
tubo di scarico	drain pipe
nastro	tape

N.B.:

- Add an insulating tube to the indoor drain pipe to prevent condensation.
- The plastic wall plugs are not supplied.

Step seven: connect the indoor unit electrical cable

1. Open the panel. Remove the screw that secures the small panel covering the terminal board.

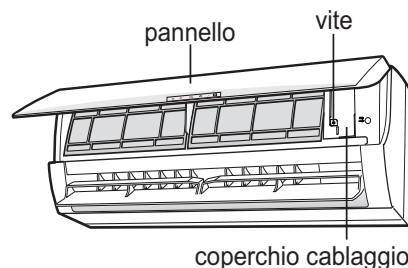

2. Insert the indoor and outdoor unit connecting cable into the rear hole corresponding to the terminal block. Then pull it out of the front.



pannello	panel
vite	screw
Coperchio cablaggio	wiring cover
foro di passaggio	cable
cavo	through-hole
cavo di alimentazione	power cable

3. Remove the cable clip. Connect the power cable to the terminal block according to colour. Tighten the screw and secure the power cable with the clip.



Note: the link card is only for reference, please take into consideration the actual one.

blu	blue
nero	black
marrone	brown
giallo-verde	yellow-green
Collegamento unità esterna	Outdoor unit connection

4. Reposition the terminal block cover and tighten the screws.

5. Close the panel.

N.B.:

- All wiring must be connected as shown on the unit's wiring diagram. All indoor and outdoor unit cables must be connected by a qualified technician.
- If the power cable is not long enough, contact the supplier for a new one. Do not attempt to extend it yourself.
- For air conditioners equipped with a plug, the plug must be easily accessible upon completion of installation.
- For air conditioners without a plug, install a circuit breaker on the line. The circuit breaker must be single-pole and the contact gap must be greater than 3mm.

Step eight: bind the pipes

1. Bind together the connecting pipe, the power cable and the drain pipe with binding tape.

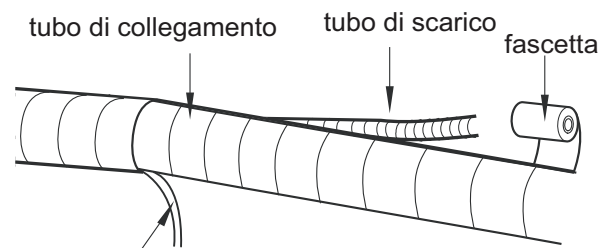
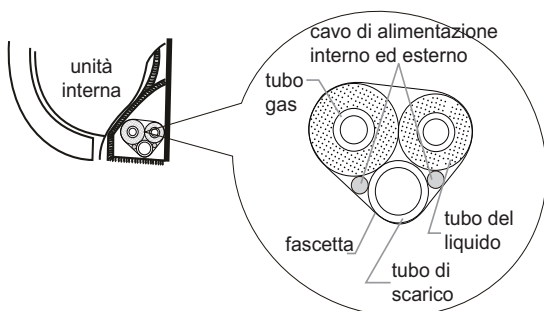

tubo di collegamento	connecting pipe
tubo di scarico	drain pipe
fascetta	binding tape
cavo di alimentazione interno	Indoor powercable

unità interna	indoor unit
cavo di alimentazione interno ed esterno	indoor and outdoor power cable
tubo gas	gas pipe
fascetta	binding tape
tubo di scarico	drain pipe
tubo del liquido	liquid pipe

2. Reserve a section of the drain pipe and power cable for installation when binding. When you have bound up to a certain point, separate the indoor power cable and then the drain pipe.

3. Bind them evenly.

4. The liquid pipe and gas pipe must be bound separately at the end.

N.B.:

The power cable and signal control cable must not be rolled or coiled.

The drain pipe must be bound at the bottom.

Step nine: hang the indoor unit

1. Insert the bound pipes into the wall pipe and route them through the hole in the wall.
2. Hang the indoor unit on the wall-installation plate.
3. Fill the gap between the pipes and the hole in the wall with sealant.
4. Secure the wall pipe.
5. Check that the indoor unit is securely installed and flush against the wall.

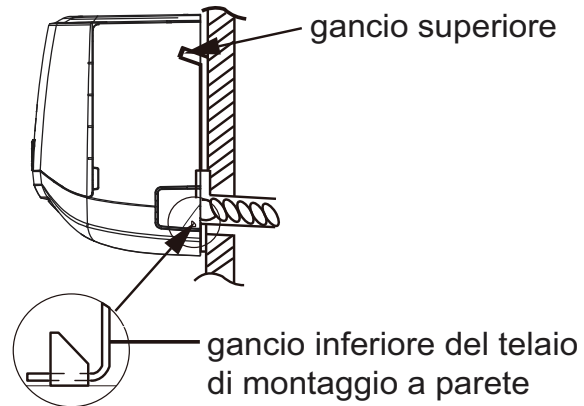
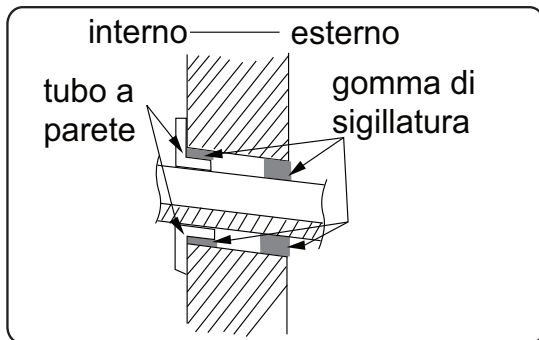

interno	indoors
esterno	outdoors
tubo a parete	wall pipe
gomma di sigillatura	rubber sealant
ganciosuperiore	upper hook
gancio inferiore del telaio di montaggio a parete	lower hook of wall-installation frame

N.B.:

- Avoid bending the drain pipe too much in order to prevent clogging.

Outdoor unit installation

Step one: secure the outdoor unit support

1. Choose a location for the unit according to the structure of the house.
2. Use expansion screws to secure the outdoor unit support in the chosen position.

N.B.:

- Take the appropriate safety measures when installing the outdoor unit.
- Make sure that the bracket can support at least four times the weight of the unit.
- The outdoor unit must be connected at least 3 cm above the ground in order to install the drain joint.
- Units with a cooling capacity of 2300 W – 5000 W require 6 expansion screws; units with a cooling capacity of 6000 W – 8000 W require 8 expansion screws; units with a cooling capacity of 10000 W – 16000 W require 10 expansion screws.

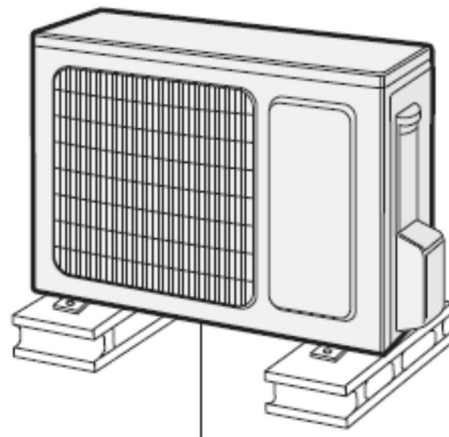

at least 3 cm above the ground

Step two: install the drain joint

1. Connect the outdoor drain joint into the hole on the chassis, as shown below.
2. Connect the drain hose into the drain hole.

Step three: secure the outdoor unit

1. Position the outdoor unit on the support.
2. Secure the foot holes of the outdoor unit with bolts.

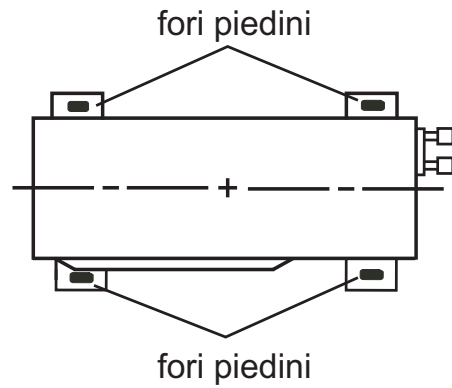
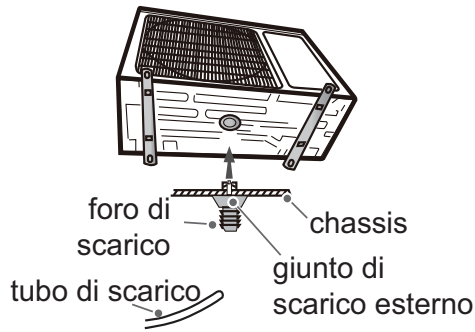

foro di scarico	drain hole
tubo di scarico	drain pipe
chassis	chassis
giunto di scarico esterno	outdoor drain joint
Fori piedini	foot holes

Step four: connect the indoor and outdoor pipes

1. Remove the screw on the right-hand handle of the outdoor unit and remove the handle.
3. Pre-tighten the union nut by hand.

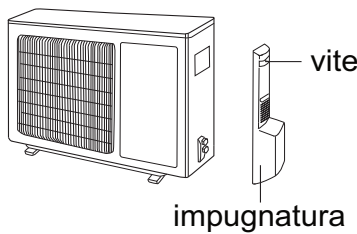

vite	screw
impugnatura	handle

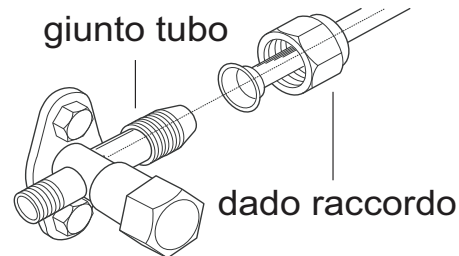

Giunto tubo	pipe joint
dado raccordo	union nut

2. Remove the screw cap of the valve and position the pipe joint in the bellmouth of the pipe.

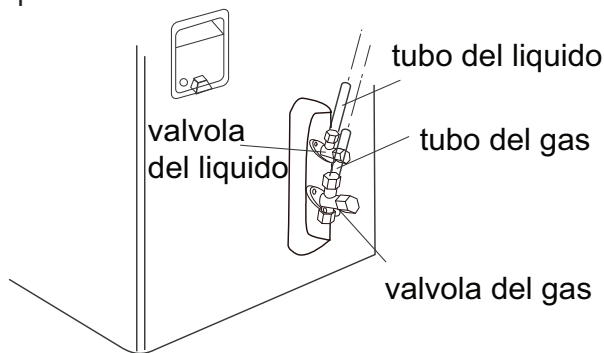

4. Tighten the union nut with the wrench according to the following table.

Hex nut diameter	Tightening torque (Nm)
Φ6.35	15 – 20
Φ9.52	30 – 40
Φ12.7	45 – 55
Φ15.88	60 – 65

valvola del liquido	liquid valve
tubo del liquido	liquid pipe
tubo del gas	gas pipe
valvola del gas	gas valve

Step five: connect the outdoor electrical cable

1. Remove the wire clip. Connect the power cable and the signal control cable (only for cooling and heating units) to the wiring terminal according to colour. Secure them with the screws.

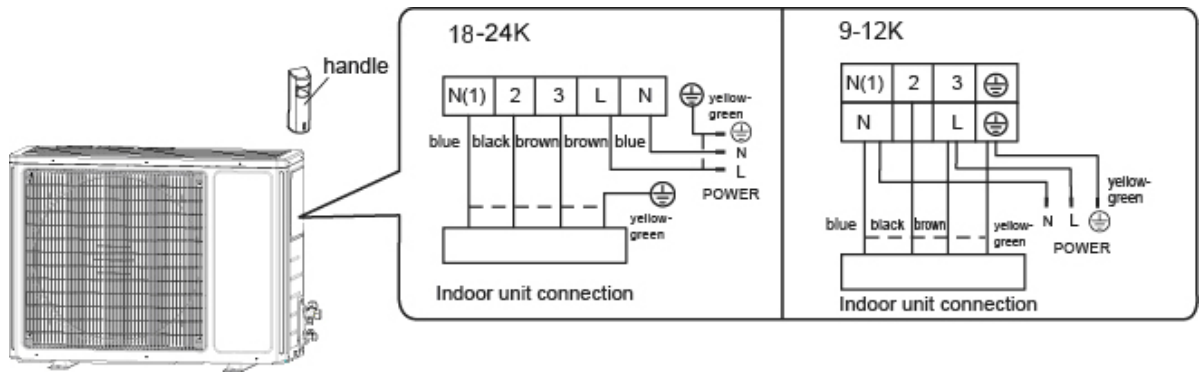

2. Secure the power cable and the signal control cable with the clip (only for cooling and heating units).

- N.B.: • Once you have tightened the screw, pull on the power cable gently to check it is secure.
 • Never cut the power cable to extend or reduce the distance.

Step six: tidy up the pipes

1. The pipes should be routed along the wall, bent only as much as is necessary and, if possible, hidden from view. Minimum pipe bending radius: 10 cm.
2. If the outdoor unit is higher than the hole in the wall, you must create a U-bend in the pipe before it enters the room to prevent rain from getting into the room.

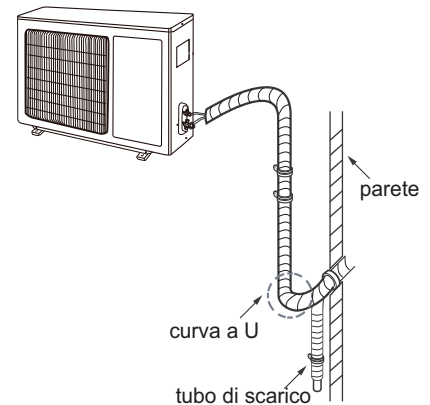

parete	wall
curva a U	U-bend
tubo di scarico	drain pipe

N.B.:

- The height of the drain pipe through the wall must not be greater than the height of the hole for the indoor unit's outlet pipe.
- Slant the drain pipe slightly downwards. The drain pipe must not be bent, raised, twisted, etc.

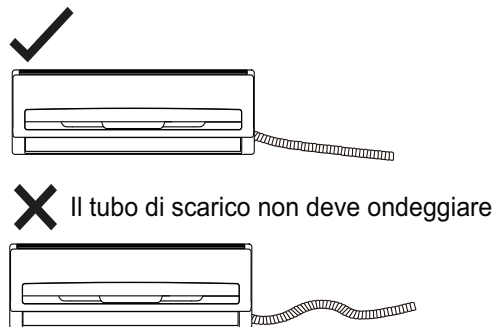
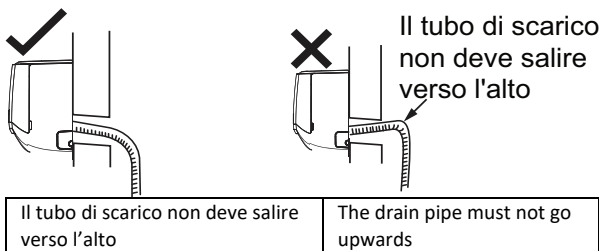

- To ensure uniform drainage, the water outlet must not be placed in water.

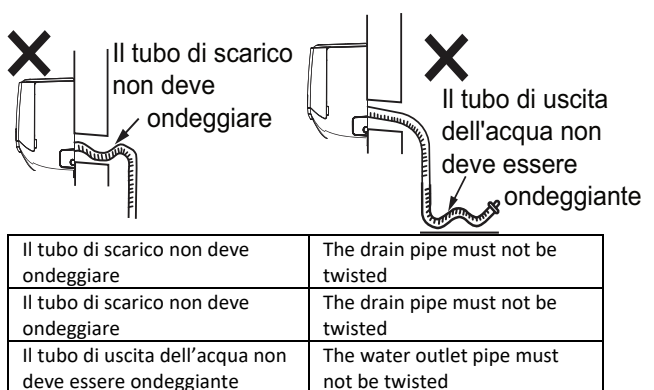
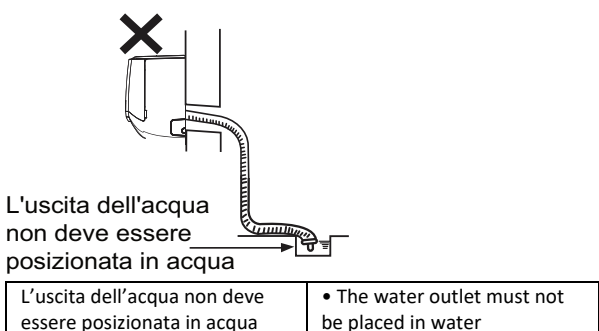

Il tubo di scarico non deve ondeggiare	The drain pipe must not be twisted
Il tubo di scarico non deve ondeggiare	The drain pipe must not be twisted
Il tubo di uscita dell'acqua non deve essere ondeggiante	The water outlet pipe must not be twisted

Vacuum pump

Using the vacuum pump

- Remove the valve caps of the liquid valve and gas valve and remove the nut of the refrigerant charge port.
- Connect the piezometer charge pipe to the refrigerant charge bore of the gas valve. Then connect the other charge pipe to the vacuum pump.
- Open the piezometer completely and let it run for 10 – 15 minutes to check if the pressure of the piezometer remains at -0.1 MPa.
- Close the vacuum pump and maintain this condition for 1 – 2 minutes to check if the pressure of the piezometer remains at -0.1 MPa. If the pressure falls, there may be a leak.

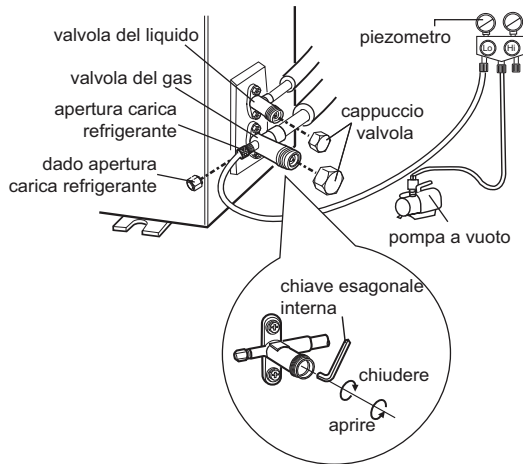

valvola del liquido	liquid valve
valvola del gas	gas valve
Aperture carica refrigerante	refrigerant charge port
dado aperture carica refrigerante	refrigerant charge port
piezometro	piezometer
Cappuccino valvola	valve cap
pompa a vuoto	vacuum pump
Chiave esagonale interna	inner hex key
chiudere	close
aprire	open

- Remove the piezometer. Fully open the plunger of the liquid valve and gas valve with the inner hex key.
- Tighten the screw caps of the valves and refrigerant charge port.
- Reinstall the handle.

Leak detection

Check for leaks using a leak detector. If you do not have a leak detector you can use soapy water.

Post-installation checks

Checks	Possible fault
Has the unit been installed securely?	The unit could fall, move or produce excessive noise.
Has the leakage test of the refrigerant been done?	Risk of condensation and dripping water.
Is the thermal insulation of the pipes sufficient?	Risk of condensation and dripping water.
Does the water drain properly?	Risk of condensation and dripping water.
Does the supply voltage match the voltage indicated on the data plate?	Risk of malfunction or damage to components.
Have the piping and electrical wiring been installed correctly?	Risk of malfunction or damage to components.
Has the unit been properly earthed?	Risk of electric leakage.
Does the power cable meet requirements?	Risk of malfunction or damage to components.
Are there any obstructions at the air inlet or outlet?	The cooling (heating) capacity may be insufficient.

Have the dust and other particles produced during installation been removed?	Risk of malfunction or damage to components.
Are the gas valve and liquid valve of the connecting tube fully open?	The cooling (heating) capacity may be insufficient.
The entrance and exit of the pipe holes have been covered?	Risk of condensation and dripping water.

TESTING AND OPERATION

Functional testing

Connect the power and press the ON/OFF button on the remote control to start operation. Press the MODE button to select AUTO, COOL, DRY, FAN and HEAT mode and check the air conditioner operates normally.

If the ambient temperature is below 16°C, the air conditioner will be unable to start cooling.

APPENDICES

Piping configuration

- Standard connecting tube length: 5, 7.5, 8 m.
- Minimum connecting tube length: 3 m.
- Maximum connecting tube length and maximum height difference:

Capacity	Maximum connecting tube length	Maximum height difference
9000 Btu/h	15	10
12000 Btu/h	20	10
18000 Btu/h	25	10
24000 Btu/h	25	10

Warning! Note the additional charge on the data plate affixed to the outdoor unit.

Additional oil and refrigerant charging

- If the length of the connecting pipe is increased by 10 m compared to the standard length, add 5 ml of refrigeration oil for every 5 m of pipe added.
- Method for calculating the amount of additional refrigerant charge (liquid pipe): amount of additional refrigerant charge = additional length of liquid pipe x additional amount of refrigerant charge per metre.

Connecting pipe diameter		Additional refrigerant
Liquid pipe (mm)	Gas pipe (mm)	(g/m)
Φ _{6,35}	Φ _{9,52}	20 (9-12K) 16 (18K)
Φ _{6,35}	Φ _{15,88}	40

Safety operation of flammable refrigerant

Qualification requirement for installation and maintenance

- All workers who engage with the refrigeration system should bear the valid certification awarded by the authoritative organization, and the qualification recognized by the industry for dealing with the refrigeration system.
- The refrigeration system can only be repaired following the methods suggested by the equipment’s manufacturer.

Installation notes

- The air conditioner mustn’t be used in a room that has running fire or heat sources (such as, working coal gas ware, operating heater).
- Do not drill holes in the circuit or burn the connection pipe.
- The air conditioner must be installed in a room that is larger than the minimum room area. The minimum room area is shown on the following “table a”.
- Leak test is mandatory after installation.

table a - Minimum room area (m ²)

Minimum room area(m ²)	Charge amount (kg)	≤1.2	1.3	1.4	1.5	1.6	1.7	1.8	1.9	2	2.1	2.2	2.3	2.4	2.5
	floor location	/	14.5	16.8	19.3	22	24.8	27.8	31	34.3	37.8	41.5	45.4	49.4	53.6
window mounted	/	5.2	6.1	7	7.9	8.9	10	11.2	12.4	13.6	15	16.3	17.8	19.3	
wall mounted	/	1.6	1.9	2.1	2.4	2.8	3.1	3.4	3.8	4.2	4.6	5	5.5	6	
ceiling mounted	/	1.1	1.3	1.4	1.6	1.8	2.1	2.3	2.6	2.8	3.1	3.4	3.7	4	

Maintenance notes

- Check whether the maintenance area or the room area meet the requirement of “table a”- the unit is only allowed to be operated in rooms that meet these requirements.
- Check whether the maintenance area is well-ventilated. - The continuous ventilation status should be kept during the entire operation process.
- Check whether there is a fire source or potential fire source in the maintenance area. Running fire is prohibited in the maintenance area and the “no smoking” sign should be hanged.
- Check whether the warning sign is in good condition, otherwise replace it.

Welding

- If it is necessary to cut or weld the refrigerant system pipes in the maintenance procedures, please follow the steps here below:
 - a. Shut down the unit and cut power supply
 - b. Eliminate the refrigerant
 - c. Vacuum with a vacuum machine
 - d. Clean the pipes with the N2 gas
 - e. Cut and weld or
 - f. Bring the unit to a service centre for welding
- The refrigerant should be recycled in a specialized storage tank.
- Make sure there aren’t any free flames near the outlet of the vacuum pump and that it’s well-ventilated.

Filling the refrigerator circuit

- Use refrigerant filling appliances specialized for R32. Make sure that different kinds of refrigerant don't contaminate one another.
- The refrigerant tank should be kept upright when filling with the refrigerant.
- Stick the label on the system after filling is finished.
- Don't overfill.
- After filling is finished, please test the unit for leakage detection before the operation test; another test for leakage detection should be carried out when the refrigerant is removed.

Safety instructions for transportation and storage

- Please use a flammable gas detector to check before unloading and opening the container.
- No fire source and no-smoking.
- According to the local rules and laws

Procedure for extending the piping

N.B.:

Improper extension of piping is the main cause of refrigerant leaks. Proceed as shown below:

1. Cut the pipe

- Check the length of the pipe based on the distance between the indoor unit and outdoor unit.
- Cut the required pipe using a pipe cutter.

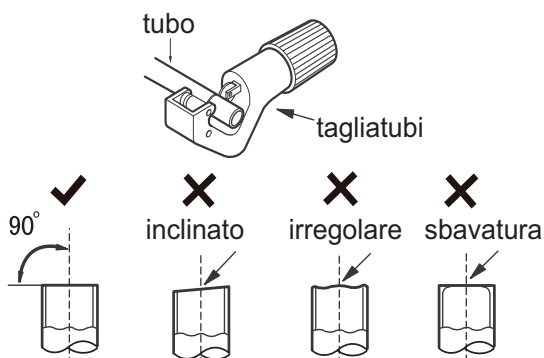

tubo	pipe
tagliatubi	pipe cutter
inclinato	slanted
irregolare	uneven
sbavatura	burred

2. Remove burrs

- Remove burrs with a file, ensuring they do not go into the pipe.

5. Expand the port

- Expand the port using a pipe expander.

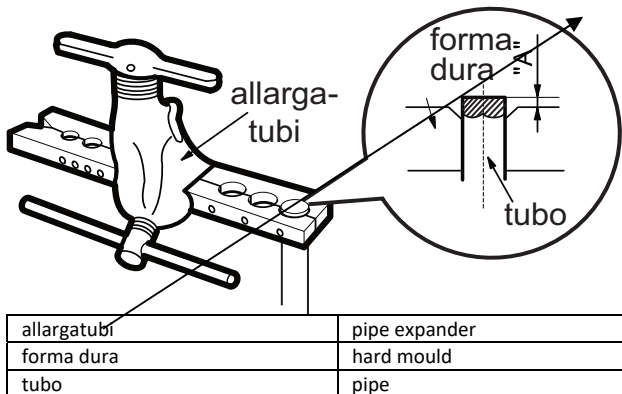

allargatubi	pipe expander
forma dura	hard mould
tubo	pipe

N.B.:

- "A" varies according to diameter:

Outdoor diameter (mm)	A (mm)	
	Max.	Min.
6.35 (1/4")	1.3	0.7
9.52 (3/8")	1.6	1.0
12.7 (1/2")	1.8	1.0
15.88 (5/8")	2.4	2.2

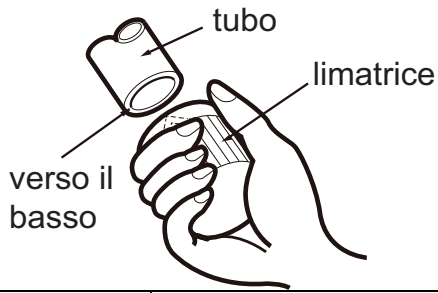

tubo	pipe
limatrice	file
verso il basso	downwards

3. Secure an insulating tube

4. Install a union nut

- Remove the union nut on the indoor connecting pipe and outdoor valve. Install the union nut on the pipe.



tubo di raccordo	union pipe
tubo	pipe

6. Inspection

Check the quality of the expanded port. If defective, expand the port again following the procedure described above.

superficie liscia

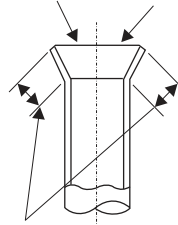

allargamento imperfetto

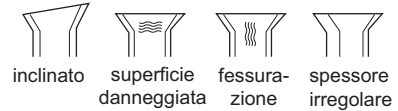

lunghezza uguale

superficie liscia	smooth surface
allargamento imperfetto	defective expansion
lunghezza uguale	equal length
inclinato	slanted
superficie danneggiata	surface damaged
fessurazione	cracked
spessore irregolare	uneven thickness

REGULATION (EU) No. 517/2014 - F-GAS

The unit contains R32, a fluorinated greenhouse gas with global warming potential (GWP) = 675. Do not release R32 into the atmosphere.

ECOWALL 9000 UE - Kg. 0,6 = 0.405 Tonn CO₂ equiv.

ECOWALL 12000 UE - Kg. 0,65 = 0,439Tonn CO₂ equiv.

ECOWALL 18000 UE - Kg. 0,77 = 0,520 Tonn CO₂ equiv.

ECOWALL 24000 UE - Kg. 1,3 = 0,878 Tonn CO₂ equiv.



improve your life

www.argoclima.com