



improve your life

X3I ECO PLUS
AIR CONDITIONERS
MONOSPLIT R32 WIFI

USER and INSTALLATION MANUAL



INDOOR UNIT

OURDOOR UNIT

X3I ECO PLUS 27 HL WF

X3I ECO PLUS 27 SH

X3I ECO PLUS 35 HL WF

X3I ECO PLUS 35 SH

X3I ECO PLUS 52 HL WF

X3I ECO PLUS 52 SH

X3I ECO PLUS 70 HL WF

X3I ECO PLUS 70 SH

Please read this manual carefully before installing and using the air conditioner, and retain for future reference.

Contents

Information for use

The Refrigerant	65
Precautions for use	66
Description of components	70

Guide to the remote control and display

Remote control button and display icons	71
Getting to know the remote control buttons	71
Getting to know the button combination functions	76
Replacing the remote control batteries	78
WiFi Guide	79
Google Home Instruction	89
Emergency operation	96

Maintenance

Care and cleaning	97
-------------------	----

Troubleshooting

Possible faults and solutions	98
Analysing faults and solutions	100

Installation instructions

Installation warnings	102
Choosing a location for installation	102
Electrical connection requirements	103

Installation

Indoor unit installation	104
Outdoor unit installation	108
Post-installation checks	112

Testing and operation

Functional testing	112
--------------------	-----

Appendices

Piping configuration	113
Safety operation of flammable refrigerant	113
Procedure for extending the piping	115
Warnings for the refrigeration system specialist	116



INFORMATION FOR CORRECT DISPOSAL OF THE PRODUCT IN ACCORDANCE WITH THE EUROPEAN DIRECTIVE 2012/19/EU

At the end of its working life this equipment must not be disposed of as an household waste. It must be taken to special local community waste collection centres or to a dealer providing this service. Disposing of electrical and electronic equipment separately avoids possible negative effects on the environment and human health deriving from an inappropriate disposal and enables its components to be recovered and recycled to obtain significant savings in energy and resources. In order to underline the duty to dispose of this equipment separately, the product is marked with a crossed-out dustbin.

This product is not intended for use by persons (including children) with reduced physical, sensory or mental abilities or who do not possess adequate experience and knowledge, unless they are supervised or instructed in the use of the product. by a person responsible for their safety. Children must be supervised to ensure that they do not play with the appliance. If you need to install, move or service the air conditioner, please contact your dealer or local service center for the procedure first. The air conditioner must be installed, moved or maintained by authorized personnel. Failure to do so could result in serious damage, personal injury or death. Radio equipment operating frequency band (s): 2400 MHz-2483 MHz
Maximum radio frequency power transmitted at the operating band frequencies of the radio equipment: 20 dBm.

REQUIREMENTS FOR INSTALLATION AND MAINTENANCE PERSONNEL

All personnel who carry out installation and / or maintenance operations on the units must be equipped with PEF (European Refrigerators License) as required by the D.P.R. n. 146/2018 implementing Regulation (EU) no. 517/2014. If another technician is required to maintain and repair the equipment, this will need to be supervised by the person who is qualified to use flammable refrigerants.

The repair must be performed according to the methodology indicated by the manufacturer of the equipment.

If you need to install, move or service the air conditioner, please contact your dealer or local service center for the procedure first. The air conditioner must be installed, moved or maintained by authorized personnel. Failure to do so could result in serious damage, personal injury or death.

Explanation of symbols



This symbol indicates the possibility of death or serious injury.



This symbol indicates the possibility of injury or damage to property.

NOTICE

Indicates important but not hazard-related information, used to indicate risk of property damage.



Indicates a hazard generally marked with the word **WARNING** or **CAUTION**.

Exception Clauses

Manufacturer will bear no responsibilities when personal injury or property loss is caused by the following reasons.

1. Damage the product due to improper use or misuse of the product;
2. Alter, change, maintain or use the product with other equipment without abiding by the instruction manual of manufacturer;
3. After verification, the defect of product is directly caused by corrosive gas;
4. After verification, the defects are due to improper operation during transportation of product;
5. Operate, repair, maintain the unit without abiding by instruction manual or related regulations;
6. After verification, the problem or dispute is caused by the quality specification or performance of parts and components that produced by other manufacturers;
7. The damage is caused by natural calamities, bad using environment or force majeure.



Appliance filled with flammable gas R32.



Before using the appliance, read the owner's manual.



Before installing the appliance, read the installation manual.



Before repairing the appliance, read the service manual.

The Refrigerant

- To realize the function of the air conditioner unit, a special refrigerant circulates in the system. The refrigerant is the fluoride R32 = GWP (Global warming potential). This refrigerant is flammable and inodorous. It can lead to explosions under certain conditions, however the flammability of this refrigerant is very low and it can be ignited only by fire.
- Compared to other common refrigerants, R32 is a non-polluting refrigerant with no harm to the ozonosphere and a lower effect upon the greenhouse effect. R32 has very good thermodynamic features which lead to a really high energy efficiency. The units therefore need less filling.

Warning:

Do not try to accelerate the defrosting process or to clean the appliance in different ways other than those recommended by the manufacturer. Should repair be necessary, contact your nearest authorized Argoclima Service Centre. Any repairs carried out by unqualified personnel may be dangerous. The appliance has to be stored in a room that doesn't have any continuously operating ignition sources. (for example: open flames, an operating gas appliance or an operating electric heater.) Do not pierce or burn.

Appliance has to be installed, operated and stored in a room with a floor area larger than X m². (Please refer to table "a" in section of " Safety Operation of Inflammable Refrigerant" for Space X.)

For repairs, strictly follow manufacturer's instructions only for appliances filled with R32 flammable gas. Be aware that refrigerants do not have any odour.

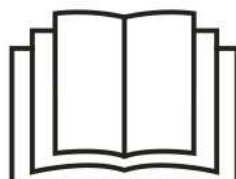

INFORMATION FOR USE

Precautions for use



WARNING

- This appliance can be used by children aged from 8 years and above and persons with reduced physical, sensory or mental capabilities or lack of experience and knowledge if they have been given supervision or instruction concerning use of the appliance in a safe way and understand the hazards involved.
- Children shall not play with the appliance.
- Cleaning and user maintenance shall not be made by children without supervision.
- To prevent the risk of fire, do not connect the air conditioner to a multifunction socket.
- Always disconnect the power before servicing or cleaning the unit.
- Do not use the appliance if the cord or plug is damaged. If the power supply cable is damaged, it must be replaced by the manufacturer or its technical assistance service, or in any case by a person with similar qualifications, in order to prevent any risk.
- To prevent the risk of electric shock, do not spray water on the indoor unit.
- Do not wash the air conditioner with water to avoid electric shocks or malfunctions.
- After removing the filter, do not touch air flaps to avoid injury.
- Do not use fire or hair dryer to dry the filter to avoid deformation or fire hazard.
- Installation or maintenance must be performed by qualified professionals. Otherwise, there is a risk of damage or personal injury.
- Do not repair air conditioner by yourself. It may cause electric shock or damage. Please contact dealer when you need to repair air conditioner.
- Do not put fingers or other objects in the air inlet/outlet grilles. Otherwise, there is a risk of damage or personal injury.
- Do not obstruct the inlet or outlet. Otherwise, a fault may occur.

- Do not spill water on the remote controller, otherwise the remote controller may be broken.
- When below phenomenon occurs, please turn off air conditioner and disconnect power immediately, and then contact the dealer or qualified professionals for service.
- Power cord is overheating or damaged.
- There's abnormal sound during operation.
- Circuit breaker trips off frequently.
- Air conditioner gives off burning smell.
- Indoor unit is leaking.
- If the air conditioner operates under abnormal conditions, malfunctions, electric shocks or fire hazards may occur.
- When turning the unit on or off using the auxiliary button, press this switch with an insulating object made of a material other than metal.
- Do not climb or place heavy objects on the top panel of the outdoor unit. Otherwise, you risk damage or personal injury.

Appendices

- Installation must be performed by qualified professionals. Otherwise, you risk damage or personal injury. Electrical safety regulations must be observed when installing the unit.
- According to the local safety regulations, use qualified power supply circuit and circuit breaker.
- Always install the power switch. Otherwise, malfunctions may occur. An omnipolar disconnecter with contact separation of at least 3 mm in all poles must be connected in the fixed wiring.
- Insert a power switch with sufficient power. Circuit breaker should be included magnet buckle and heating buckle function. It can protect the overload and circuit-short.
- Air conditioner should be properly grounded. Incorrect grounding may cause electric shock.
- The yellow-green wire in air conditioner is grounding wire, which can't be used for other purposes.
- Don't use unqualified power cord.

- Unstable power supply or incorrect wiring may result in electric shock, fire hazard or malfunction. Please install proper power supply cables before using the air conditioner.
- Correctly connect the phase, neutral and ground wires of the power outlet.
- Be sure to disconnect the power supply before proceeding with any work relating to the electrical circuit and safety.
- Do not put through the power before finishing installation.
- If the power cord is damaged, it must be replaced by the manufacturer, its service agent or similarly qualified persons in order to avoid danger.
- The temperature of refrigerant circuit will be high, please keep the interconnection cable away from the copper tube.
- The appliance must be installed in accordance with national wiring regulations.
- The air conditioner is the first class electric appliance. It must be properly grounded with specialized grounding device by a professional. Please make sure it is always grounded effectively, otherwise it may cause electric shock.
- The ground resistance must comply with national electrical safety standards.
- The appliance must be positioned so that the plug is accessible.
- All wires of indoor and outdoor units must be connected by a professional.
- If the length of power connection wire is insufficient, please contact the supplier for a new one. Do not make extensions yourself.
- For the air conditioner with plug, the plug should be reachable after finishing installation.
- For the air conditioner without plug, a circuit breaker must be installed in the line.
- If you need to move the air conditioner to another location, contact qualified personnel. Otherwise, you risk damage or personal injury.
- Choose a location out of the reach of children and away from animals or plants. If this is not possible, install a safety fence.
- The indoor unit should be installed close to the wall.

- Bear in mind that the appliance is filled with flammable gas R32. Improper handling of the device creates the risk of serious injury to persons and damage to materials. Details of this refrigerant can be found in the "refrigerant" chapter.
- Check that the maintenance area or room surface meets the requirements of the identification plate.
- Use is only permitted in premises that meet the requirements indicated on the identification plate.
- Check that the maintenance area is adequately ventilated.
- Continuous ventilation conditions must be maintained during the operation process.
- Check that the area intended for maintenance does not present any sources of ignition, even potential ones.
- The introduction of naked flames in the maintenance area is prohibited, while the posting of the "no smoking" sign is mandatory.
- Check that the equipment markings are in good condition.
- Replace any unclear or damaged warning marks.
- Check for the presence of flammable gases with the appropriate detector before unloading and opening the container.
- Do not introduce combustion sources and do not smoke.
- Comply with local laws and regulations.
- The use of the air conditioner is not allowed in rooms with an open flame (for example, combustion sources, coal gasification systems, gas heating systems).
- It is not allowed to drill holes or burn the connecting pipe.
- The air conditioner must be installed in a room larger than the minimum area of the room. Check the minimum area of the room on the identification plate or on the table a.
- At the end of the installation it is necessary to perform a leak test.
- Instructions for installing and using this product are provided by the manufacturer.

Operating limits

Cooling mode: from -15°C to +43°C (outdoor temperature)

Heating mode: from -15°C to +24°C (outdoor temperature)





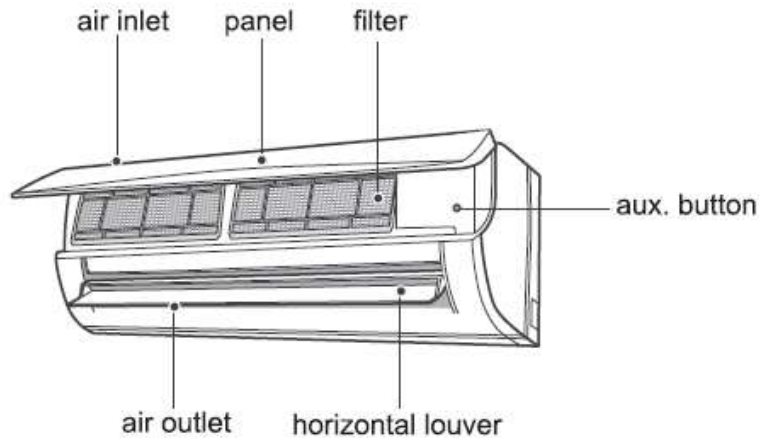



Description of components

Indoor unit



The display may vary from the graphic above. Please refer to the purchased product for the actual display content and positions).

Display

Heat mode		 R:red indicator (only for heat model)
Cool mode		 W:white indicator
Dry mode		 G:green indicator  O:orange indicator
Temp. indicator	26	
Power indicator		



Outdoor unit

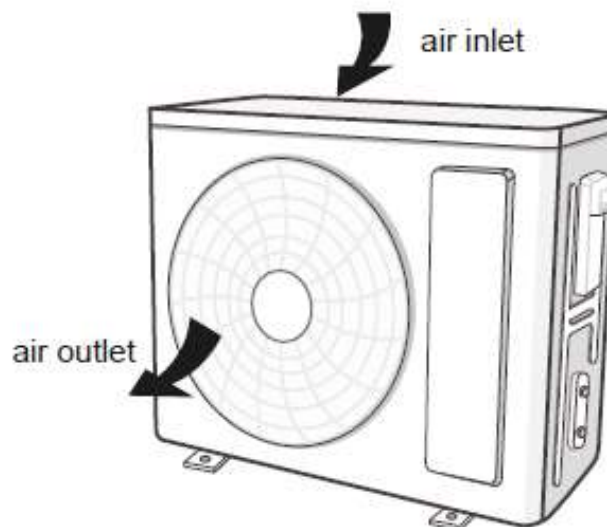

GUIDE TO THE REMOTE CONTROL AND DISPLAY

Remote control buttons and display icons



	I feel function	
	Set fan speed	
	Turbo Mode	
	Send signal	
Operation mode		Auto Mode
		Cool Mode
		Dry Mode
		Fan Mode
		Heat Mode
		Sleep Mode
		8°C heating function
	Health Mode	
	Scavenging Function	
	Quiet	
	X-FAN Function	
Display Temperatura		Set Temperatura
		Indoor Temperature
		Outdoor Temperature
	Clock	
	Set Temperature	
	WiFi Function	
	Set Time	
	TIMER ON / TIMER OFF	
	Light	
	Left & Right swing	
	Up & Down swing	
	Child lock	

Getting to know the remote control buttons

When you connect the power, the air conditioner will emit a beep. The power indicator will illuminate (red). You will now be able to control the air conditioner with the remote control.

- With unit on, when you press the ON/OFF button on the remote control, the icon on the remote control display will flash once and the air conditioner will emit a beep. This means that the signal has been sent to the unit. When the unit is on, the icons for the set functions will appear on the display.
- This remote control can control the temperature in Auto mode.
- If the air conditioner is equipped with WIFI or wired control, you must first control the unit in Auto mode with the standard remote control and then you can connect it to the app and set the temperature in Auto mode via smart-phone or wired control.
- If the remote control is combined with a unit that can't control the temperature in Auto mode, the temperature set in this mode may not be valid or the temperature shown on the unit display may not match that shown on the remote control's display in Auto mode.

ON/OFF button

Press the ON/OFF button to turn the air conditioner on or off. When you turn on the air conditioner, the power indicator  on the indoor unit's display will illuminate (green). The colour varies for different models. The indoor unit will emit a beep.

MODE button

Press this button to select the desired operating mode.

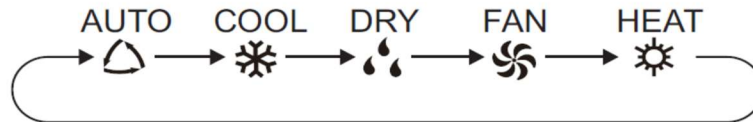





- When you select automatic mode, the air conditioner will operate automatically according to the factory settings. The set temperature cannot be adjusted and will not be displayed. Pressing the "FAN" button will allow you to adjust the fan speed. Pressing the "SWING" button will allow you to adjust the angle of airflow.
- When you select cool mode, the air conditioner will run in cool mode. The ❄️ indicator will illuminate on the display. Press "▲" or "▼" to adjust the set temperature. Press the "FAN" button to adjust the fan speed. Pressing the "SWING" button will allow you to adjust the angle of airflow.
- When you select dry mode, the air conditioner will run at low speed in dry mode. The 💧 indicator will illuminate on the display. The fan speed cannot be adjusted in this mode. Pressing the "SWING" button will allow you to adjust the angle of airflow.
- When you select fan mode, the air conditioner will operate only the fan, blowing air without cooling or heating. All the indicators will switch off. Press the "FAN" button to adjust the fan speed. Pressing the "SWING" button will allow you to adjust the angle of airflow.
- When you select heat mode, the air conditioner will run in heat mode. The ☀️ indicator will illuminate on the display. Press "▲" or "▼" to adjust the set temperature. Press the "FAN" button to adjust the fan speed. Pressing the "SWING" button will allow you to adjust the angle of airflow.

N.B.:

To prevent blasts of cold air from being blown into the room, there will be a delay of 1 – 5 minutes after selecting heat mode before operation begins. (The actual delay will depend on the indoor ambient temperature).
The temperature can be set between 16 – 30°C and four fan speeds are available: automatic, low, medium and high.

FAN button

Pressing this button will allow you to cycle through and set the fan speed: automatic (AUTO), Low () Low-medium () Medium () Medium-high () High ()



N.B.:



The fan speed in dehumidification mode is low.

Pressing the ventilation speed button for 2 seconds in Cooling or Dehumidification mode activates the X-FAN function and the icon appears on the remote control: the unit will continue to ventilate for a few minutes, even after switching off the unit, to dry the battery of the indoor unit, thus preventing the formation of mold. This function is not available in Auto, Ventilation or Heating mode.

If the X-FAN function has been selected: after turning off the unit with the ON / OFF button, the indoor unit fan will continue to run for a few minutes at low speed. During this time, press the FAN key for 2 seconds to stop the fan.

If the X-FAN function is not selected, when the air conditioner is switched off by pressing the ON / OFF button, the fan goes off together with the unit.

TURBO button

In cool/heat mode, press this button to switch to rapid cool/heat mode. The  icon will appear on the remote control display. Press this button again to exit the TURBO function. The  icon will disappear from the display. If start this function, the unit will run at super-high fan speed to cool or heat quickly so that the ambient temperature approaches the pre-set temperature as soon as possible.

▲ / ▼ buttons

Press "▲" or "▼" once to increase or decrease the set temperature by 1°C. Press and hold "▲" or "▼" for 2 seconds to rapidly adjust the set temperature on the remote control. When set-up is complete, release the button and the indoor unit's temperature indicator will change accordingly. (The temperature cannot be adjusted in automatic mode).

When setting the TIMER ON, TIMER OFF or CLOCK, press "▲" or "▼" to adjust the time. (Please refer to the relevant sections for the CLOCK, TIMER ON and TIMER OFF buttons).

SWING (Horizontal) button

Press this button to set the angle of inclination of the flap to the left and right. The flow outlet angle can be set circularly, according to the sequence shown below:

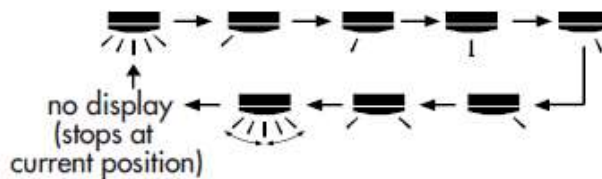









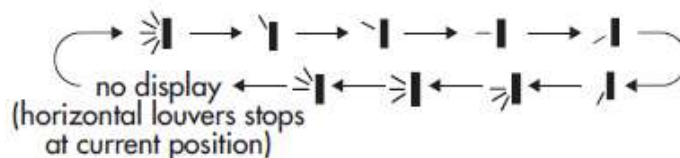

Note:

- Keeping this button pressed for more than 2 seconds the flap will swing to the left and right; leaving the key the flap will stop and the current position of the flap will be maintained.
- In the SWING mode, when switching from off to this mode, if you press the button again after 2 sec. has elapsed, the unit will go directly off; if instead the key is pressed a second time before 2 sec. has passed, the change in the position of the flap will follow the sequence illustrated above.

SWING (vertical) button

Press this button to set the swing angle (up/down). You can cycle through and set the fan's angle of airflow as shown below:



- When you select , the air conditioner will operate the fan automatically. The horizontal flap will automatically tilt up and down to the maximum angle.
- When you select , , , , , the air conditioner will operate the fan in a fixed position. The horizontal flap will stop in a fixed position.
- When you select , , , the air conditioner will operate the fan at a fixed angle. The horizontal flap will deliver air at a fixed angle.
- Hold and press the  button for 2 seconds to set the desired tilt angle. Release the button once you have reached the desired angle.

N.B.:

- , ,  may not be available. When the air conditioner receives this signal, the fan will start operating in automatic mode.

SLEEP button

By pressing this button you can select Sleep 1 , Sleep 2 , Sleep 3  and cancel the Sleep function.

- **SLEEP 1** works in cooling and dehumidification mode: after one hour of unit operation, the temperature will increase by 1°C, after 2 hours it will increase by 2°C; in heating mode, after one hour of unit operation, the temperature will decrease by 1°C and after two hours will decrease by 2°C.

- **SLEEP 2** the air conditioning operates on the basis of pre-set temperature curves.

In cooling mode:

1. When the initial temperature is set to 16°C-23°C, after activating the Sleep function, the temperature will increase by 1°C every hour, after three hours the temperature will stabilize, after 7 hours the temperature will decrease by 1°C and the unit will start working constantly.

2. When the initial temperature is set to 24°C-27°C, after activating the Sleep function, the temperature will increase by 1°C every hour, after two hours the temperature will stabilize, after 7 hours the temperature will decrease by 1°C and the unit will start working constantly.

In heating mode:

1. When the initial temperature is set to 17°C-20°C, after activating the Sleep function, the temperature will decrease by 1°C every hour, after one hour the temperature will decrease and the unit will maintain this constant temperature.

2. When the initial temperature is set to 21°C-27°C, after activating the Sleep function, the temperature will decrease by 1°C every hour, after two hours the temperature will decrease and the unit will maintain this constant temperature.

3. When the initial temperature is set to 28°C-30°C, after activating the Sleep function, the temperature will decrease by 1°C every hour, after three hours the temperature will decrease and the unit will maintain this constant temperature.

- **SLEEP 3**: it is possible to customize the sleep curve: in this mode, keep the "TURBO" key pressed for a long time to access the setting of the CUSTOM SLEEP function.

1. The remote control timer display shows "1 hr" and the set temperature indication "88" displays the corresponding temperature of the last set sleep curve and flashes (the first data item is linked to the initial values of the curve set in factory).

2. Press "▲" and "▼" to adjust the corresponding temperature. After adjustment, press the "TURBO" key to confirm.

3. At this point, the time of the timer on the remote control increases automatically in steps of 1 (ie "2 hr" or "3 hr" ... or "8 hr"). The set temperature indication "88" displays the corresponding temperature of the last set sleep curve and flashes.

4. Repeat steps (2) and (3) until the temperature setting is complete for 8 hours; at this point the sleep curve is set correctly. When this operation is completed, the remote control resumes displaying the time of the initial timer and the temperature displayed is the one initially set.

I FEEL function

Press this button to start the I FEEL function. The  icon will appear on the remote control display. When you select this function, the remote control will send the detected ambient temperature to the indoor unit, which will

then adjust its operation automatically based on the difference between the detected temperature and the set temperature.

Press the button again to exit the I FEEL function. The  icon will disappear from the display.

The remote control should be positioned near the user when this function is selected. The remote control should not be placed anywhere high or low temperatures may occur to avoid inaccurate ambient temperature detection. Place the remote control near the user when this function is set. Do not place the remote control near high or low temperature objects to avoid an inaccurate ambient temperature. Position the remote control where the indoor unit can receive the remote control signal.

TIMER ON / TIMER OFF button

SETTING TIMER ON



This function allows you to program the air conditioner to turn on. When you press this button, the  icon will disappear from the display and the word "ON" will flash on the remote control display. Press "▲" or "▼" to adjust the TIMER ON setting.

Press and hold "▲" or "▼" for 2 seconds to rapidly change the time until you reach the desired value. Press TIMER ON to confirm. The word "ON" will stop flashing. The  icon will re-appear on the display.

CANCELLING TIMER ON

If the TIMER ON function is enabled, press the TIMER ON button to cancel the setting.

SETTING TIMER OFF

This function allows you to program the air conditioner to turn off. When you press this button, the  icon will disappear from the display and the word "OFF" will flash on the remote control display. Press "▲" or "▼" to adjust the TIMER OFF setting. Press and hold "▲" or "▼" for 2 seconds to rapidly change the time until you reach the desired value. Press "TIMER OFF". The word "OFF" will stop flashing. The  icon will re-appear on the display.



CANCELLING TIMER OFF

If the TIMER OFF function is enabled, press the TIMER OFF button to cancel the setting.

N.B.:

- You can set the TIMER ON and TIMER OFF function in OFF and ON mode.
- Before you set the TIMER ON or TIMER OFF function, set the clock.
- When the TIMER ON or TIMER OFF function is enabled, the air conditioner will turn on or off according to the set time. Turning the air conditioner ON/OFF will not affect the setting.

CLOCK button

Press this button to set the clock. The  icon will flash on the remote control display. Press "▲" or "▼" within 5 seconds to set the clock. Each time you press "▲" or "▼", the clock will increase or decrease by 1 minute. Press and hold "▲" or "▼" for 2 seconds to rapidly change the time. Release the button when you reach the desired time. Press "CLOCK" to confirm the time. The  icon will stop flashing.

N.B.:

- The time displays in the 24-hour clock format.
- If no adjustment is made for 5 seconds the remote control will exit the setting mode. This also applies to the TIMER ON/OFF function.

QUIET button

1. When the Quiet function is selected, the symbol will appear on the display .

2. In cooling mode the internal fan works with 4 steps of speed; 10 minutes later or when the indoor temperature is $\leq 28^{\circ}\text{C}$, the internal fan will operate at step 2 or in quiet mode, ie in accordance with a comparison between the internal temperature of the environment and the set temperature.

3. In heating mode the internal fan operates with step 3 of speed or in quiet mode, ie in accordance with a comparison between the internal temperature of the room and the set temperature.



4. In the dehumidification and ventilation mode the internal fan operates in quiet mode.

5. In auto mode the internal fan operates in auto quiet mode according to the current modes: cooling, heating and ventilation.

Wi-Fi button

Press this button to start the Wi-Fi function. When the Wi-Fi function is active, the "Wi-Fi" icon will appear on the remote control display. When the remote control is off, press and hold the "Mode" button and the "Wi-Fi" button simultaneously for 1 sec to return to the factory settings.

LIGHT button

Press this button to turn off the indoor unit's display light. The  icon will disappear from the remote control display. Press this button again to turn on the display light. The  icon will appear on the display.

HEALTH/SCAVENGING button



The HEALTHY function means that cold plasma kills bacteria, removes odors and releases negative oxygen ions.

The SCAVENGING or purification function it's not available.

TEMP button

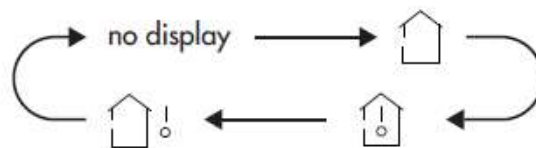
Pressing this button will allow you to display the set temperature, the indoor ambient temperature, or the outdoor ambient temperature on the indoor unit's display. You can cycle through the settings on the remote control display as shown below:



- When you select  or "no display" with the remote control, the set temperature will appear on the indoor unit's display.
- When you select  with the remote control, the indoor ambient temperature will appear on the indoor unit's display.
- When you select  with the remote control, the outdoor ambient temperature will appear on the indoor unit's display.

N.B.:

- It is not possible to display the outdoor ambient temperature on all models. The indoor unit will receive the  signal but will display the set temperature.
- The set temperature will appear on the unit's display on start-up, if enabled to do so.
- When you select to display the indoor or outdoor ambient temperature, the indoor unit will display the corresponding temperature for three to five seconds, after which it will automatically revert to displaying the set temperature.

Getting to know the button combination functions

X-FAN function

By holding down the FAN button for 2 seconds in Cool (cooling) or DRY (dehumidification) mode, the icon  will appear and the internal fan will continue to operate for a few minutes in low ventilation speed, even when the unit is turned off. This is to allow the evaporator of the indoor unit to dry, thus avoiding the formation of mold. When the unit is switched on, the X-fan function is not set by default.

This function is not available in AUTO, fan and heat modes.

If you want to stop the X-fan function, press and hold the FAN button again for 2 seconds.

Autoclean function

With the unit off, press and hold the MODE and FAN buttons simultaneously for 5 seconds to activate or deactivate the automatic cleaning function. When the automatic cleaning function is activated, the indoor unit displays "CL".

The function will see condensation, ice formation, defrosting and drying phases take place in sequence aimed at eliminating all residues of dust and pollutants and any trace of condensation from the evaporator. This will always allow clean air to be introduced into the environment and to preserve the efficiency of the heat exchanger

During the automatic evaporator cleaning process, the unit will perform either rapid cooling or rapid heating. There may be some noise and the air conditioner may blow out cold or hot air. During the cleaning process, make sure the room is well ventilated.

The automatic cleaning function can only work in normal room temperature. If the room is dusty, clean it once a month; otherwise, once every three months. After activating the automatic cleaning function, you can leave the room. At the end of the automatic cleaning, the air conditioner will go back to stand-by.

Energy saving function

In cool mode, press the TEMP and CLOCK buttons simultaneously to start or stop the energy saving function. When you start the energy saving function, "SE" will appear on the remote control display and the air conditioner will automatically adjust the set temperature according to the factory settings to achieve the best energy-saving effect. Press TEMP and CLOCK again simultaneously to exit the energy saving function.

N.B.:

- When the energy saving function is enabled, the fan will operate at the default automatic speed and cannot be adjusted.
- When the energy saving function is enabled, the set temperature cannot be adjusted. The remote control will not send a signal to the unit when the TURBO button is pressed.
- The SLEEP and energy saving functions cannot operate simultaneously. If the energy saving function was set in cool mode, press the SLEEP button to cancel it. If the SLEEP function was set in cool mode, start the energy saving function to cancel it.



8°C heating function

In cool mode, press the TEMP and CLOCK buttons simultaneously to start or stop the 8°C heating function. When this function is enabled,  and 8°C will appear on the remote control display and the air conditioner will continue to operate at 8°C. Press TEMP and CLOCK again simultaneously to exit the 8°C heating function.

N.B.:

- When the 8°C heating function is enabled, the fan will operate at the default automatic speed and cannot be adjusted. The remote control will not send a signal to the unit when the TURBO button is pressed. The SLEEP and 8°C heating functions cannot operate simultaneously. If the 8°C heating function was set in cool mode, pressing the SLEEP button will cancel it. If the SLEEP function was set in cool mode, starting the 8°C heating function will cancel it.
- When the temperature display is in °F, the remote control will show that the unit is operating at 46°F.

Remote control button lock function

Press "▲" and "▼" simultaneously to enable or disable the remote control button lock function. When this function is enabled,  will appear on the remote control display. If you attempt to operate the remote control, the  icon will flash three times and no signal will be sent to the unit.

Switching temperature display

In OFF mode, press the "▼" and "MODE" buttons simultaneously to switch from a temperature display in °C to °F.

Operating guide

1. When you connect the power, press the "ON/OFF" button on the remote control to turn the air conditioner on.
2. Press the MODE button to select the desired operating mode: AUTO, COOL, DRY, FAN or HEAT.
3. Press "▲" or "▼" to adjust the desired temperature. (The temperature cannot be adjusted in automatic mode.)
4. Press the "FAN" button to set the desired fan speed: automatic, low, medium or high.
5. Press the "SWING" button to adjust the fan's angle of airflow.

Replacing the remote control batteries

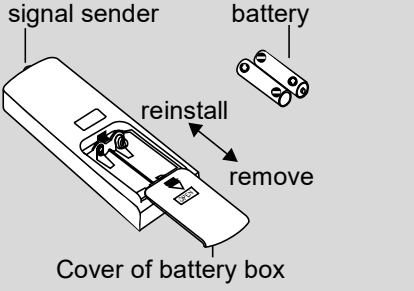
<ol style="list-style-type: none">1. Remove the battery compartment cover, marked with  (see image to right), by sliding it in the direction of the arrow.2. Use only two AAA – LR03 1.5V batteries. Make sure the + and – ends are facing the correct direction.3. Slide the battery compartment cover back into place.	 <p>The diagram illustrates the process of opening the battery compartment cover. A hand is shown sliding the cover, which has an arrow pointing to the right, away from the remote control. This reveals two battery slots. A battery is shown being inserted into one of the slots, with arrows indicating the 'reinstall' and 'remove' directions. The cover is labeled 'Cover of battery box'.</p>
-------------------------------------------------------------------------------------------------------------------------------------------------------------------------------------------------------------------------------------------------------------------------------------------------------------------------------------------------------------------------------------------------------------------------------------------	-------------------------------------------------------------------------------------------------------------------------------------------------------------------------------------------------------------------------------------------------------------------------------------------------------------------------------------------------------------------------------------------------------------------------------------------------------------------------------------------

N.B.:

- When the unit is operating, point the remote control's signal transmitter at the indoor unit's receiver.
- The distance between the transmitter and the receiver must not exceed 8 metres and should remain free of obstacles.
- If the room contains a fluorescent light or cordless telephone, signal interference is likely to occur.
- When the remote control is not used for a month or more, remove the batteries.
- Use batteries of the same type when replacing the batteries, as necessary.
- If the icons on the remote control display are blurred or not visible, replace the batteries.
- Do not attempt to recharge the batteries. Replace both batteries at the same time.
- Do not throw batteries into fire; they may explode.

INFORMATION FOR CORRECT DISPOSAL OF BATTERIES IN ACCORDANCE WITH EUROPEAN DIRECTIVE 2006/66 / EC and AMENDMENTS INTRODUCED BY DIRECTIVE 2013/56 / EU



Please replace the battery when its electric charge is exhausted: at the end of its useful life this battery must not be disposed of with unsorted waste. It must be delivered to appropriate separate collection centers or to retailers that provide this service. Disposing of a battery separately allows you to avoid possible negative effects on the environment and human health resulting from inappropriate disposal and allows you to recover and recycle the materials it is made of, with important savings in energy and resources. To emphasize the obligation to dispose of the batteries separately, the symbol of the crossed out bin is shown on the battery. Illegal disposal of the product by the user involves the application of administrative penalties provided for by current legislation.

WIFI GUIDE

The air conditioner must be in constant connection with a wireless router or access point connected to the internet. Mobile devices such as smartphones and tablets, on which dedicated applications are installed and the Wi-Fi modules subsequently configured, can be used as remote controls once connected to the internet.

How to set up and operate the air conditioner with Wifi

1. Make sure that the device (smartphone or Tablet) used is equipped with a standard version of Android (version 4.4 or higher) and iOS (iOS7.0 or higher) as the operating system. For more details refer to the App.
2. Units can be connected and controlled only via Wi-Fi network or via Hotspot function.
3. Routers with WEP encryption are not supported.
4. The application interface is universal for all products and many features may not match for all units. It may vary depending on the operating system used or the update in use. Refer to the current version.
5. If the access protection on your Router is active in the "MAC Filter" / "MAC address filter" item, enable the access to the network of the MAC address of the device.

Installation and use instruction

1. Frame the QR Code using a QR Code Reader



or search for the "**EWPE SMART**" application in the app store download and install the application.

Install the App by referring to its guide. Once the installation is complete, the icon  appears on the smartphone's home page.

NB:

Before starting any procedure, disconnect the power supply from the product, allow a few minutes to pass and reconnect it.

2. Registration and access

After installing the application, open "**EWPE SMART**" and click Sign up to register.

PLEASE NOTE:

- USERNAME: must be UNIQUE, composed of name + number, without spaces (eg **Rossi57**)
- Personal email: if already registered, retrieve Username / Password. It is not possible to create another account with the same mail.
- PASSWORD: must have at least one capital letter, symbols or special characters (- ;, etc.) and numbers.
- Repeat PASSWORD written above
- EUROPE country

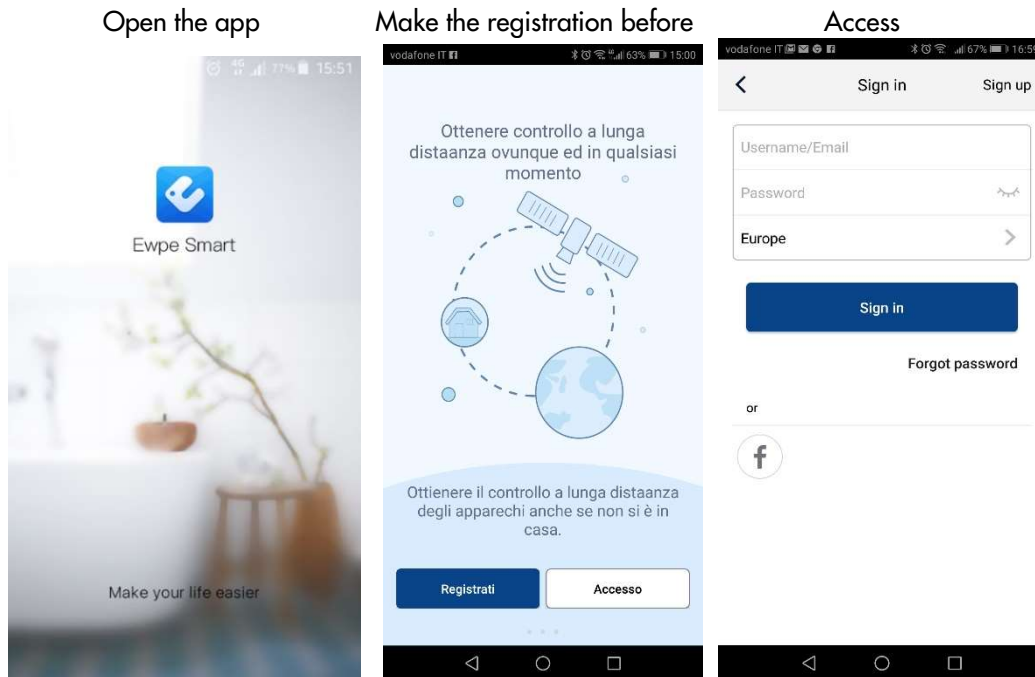

3. Adding units

Clicking on the icon of the little man opens a menu that includes, among other things, the "Help" function. Follow the instructions that appear on your device to add the unit. or add a new unit, press + in the upper right corner of the homepage.

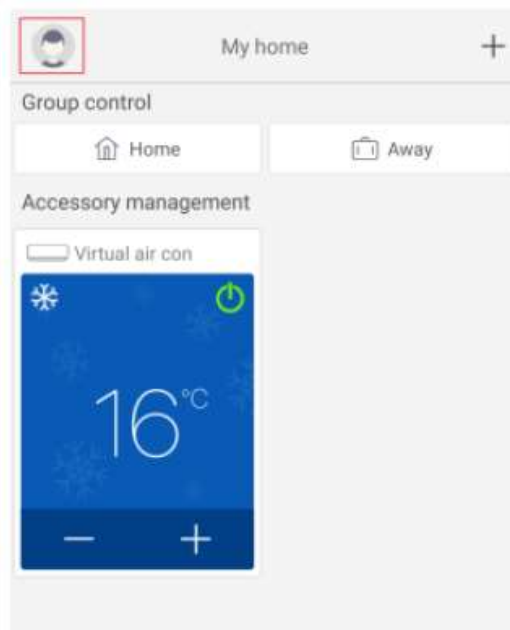

A menu appears with all the categories of devices that can be connected. Select the relevant type: In case of **residential air conditioner**: the first box on left:

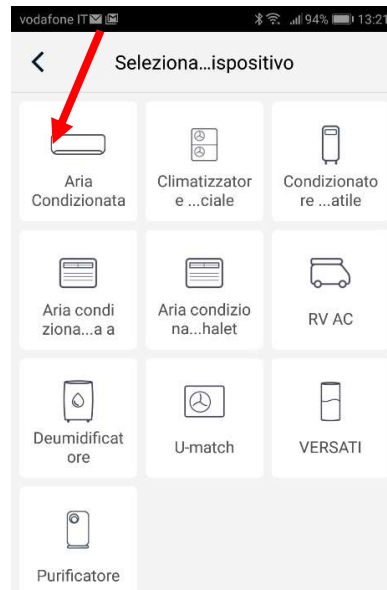

After choosing the category of interest, proceed with the reset of the unit. Different unit reset systems can be chosen depending on the type of unit / system and remote control (with or without wifi key).

Follow step by step the operative instructions depending on the selected reset system.



After performing the reset following the instructions, click on Next to automatically add the unit (it's necessary to enter Wi-Fi password).



WIRE CONTROL OR PORTABLE AIR CONDITIONER (CONTROL PANEL RESET)
 Press the button on the touch panel. With the unit off, press and hold the "Wifi" button for 10 seconds. When the unit beeps, it means the reset has been successful.
 NB: The configuration must be done within 2 minutes. If it does not happen within 2 minutes, repeat the reset operation.

REMOTE CONTROL WITH WIFI BUTTON
 Direct the remote control towards the unit. With the remote control off, press the "Mode" + "Wifi" buttons simultaneously for 1 second. When the unit beeps, it means that the reset has been successful.
 NB: The configuration must be done within 2 minutes. If it does not happen within 2 minutes, repeat the reset operation.

REMOTE CONTROL WITHOUT WIFI BUTTON (MODE and TURBO)
 Direct the remote control towards the unit. Press the "Mode" + "Turbo" buttons simultaneously for 10 seconds. After the unit has twice produced an acoustic signal, this will mean that the reset has been successful.
 NB: The configuration must be done within 2 minutes. If it does not happen within 2 minutes, repeat the reset operation

Alternatively, after setting and resetting the air conditioner, click on *Add appliance manually* in the upper right corner to select the Wi-Fi network to associate. Select the desired network and continue the configuration.

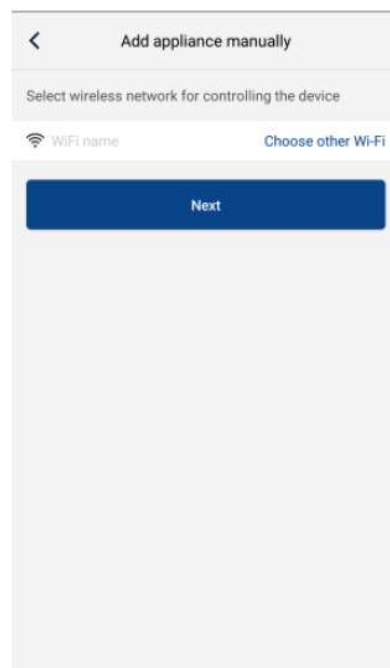
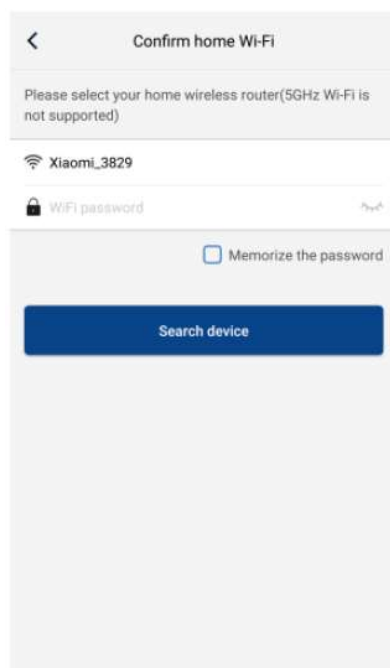

After performing the electrical reset of the unit and entering the information, perform a search for the unit (Search appliance) and continue the configuration.

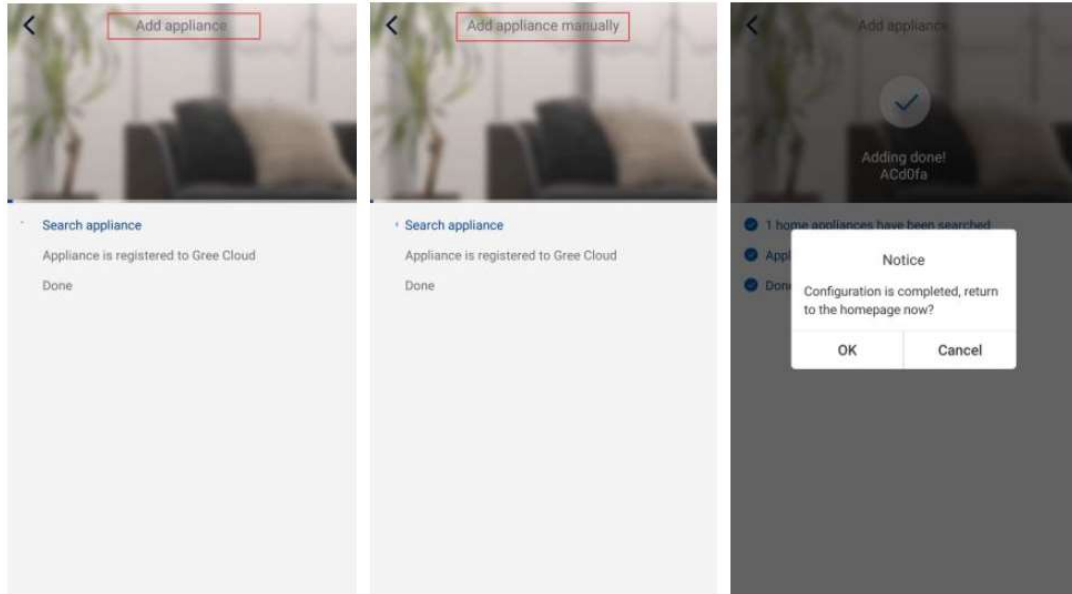

Configuration of the main functions

In the Homepage click on the device you wish to control and access the operating interface of it.

1. Select, operating mode, temperature and fan speed.

- Mode

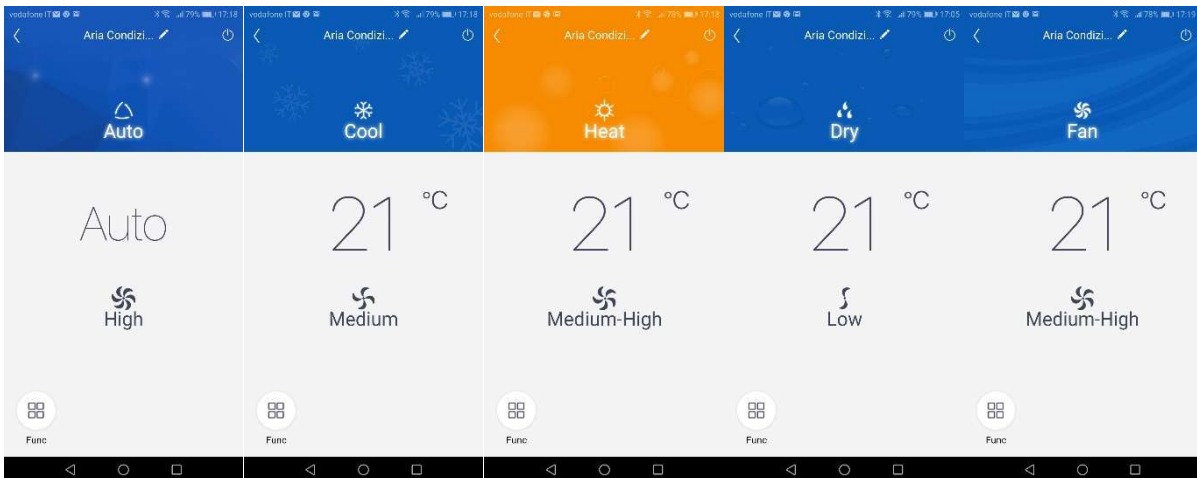

- Temperature for each mode: just slide your finger on the indicated temperature

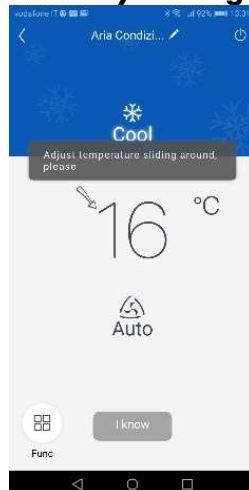

- **Ventilation speed for each mode: just slide your finger on the fan symbol (the adjustment possibilities vary depending on the mode)**



2. Set advanced functions

Click Function (Func) in the lower left corner of the interface to enter the advanced settings.

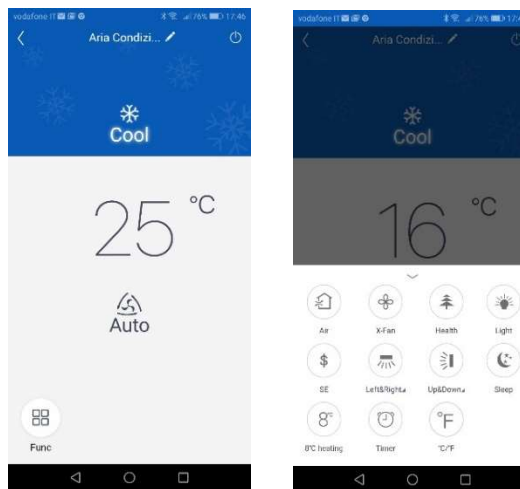

X-FAN function

Vertical flap swinging

Horizontal flap swinging
(if available)

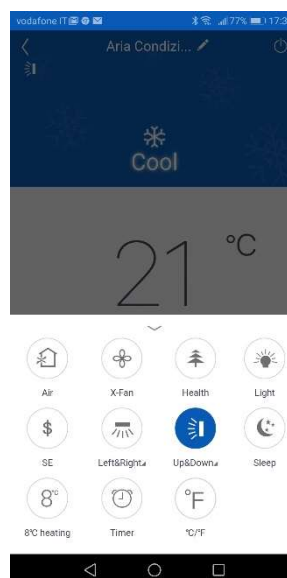

Sleep function



Light on indoor unit display



Temperature unit conversion

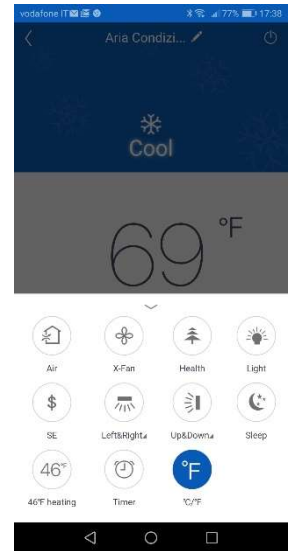

Swing setting

Click Up & down swing to turn the swing function on or off. Click the arrow in the lower right corner of the icon to go to the next screen and set the swing level.

List of Preselections

Click Timer. Then click + and make adjustments.

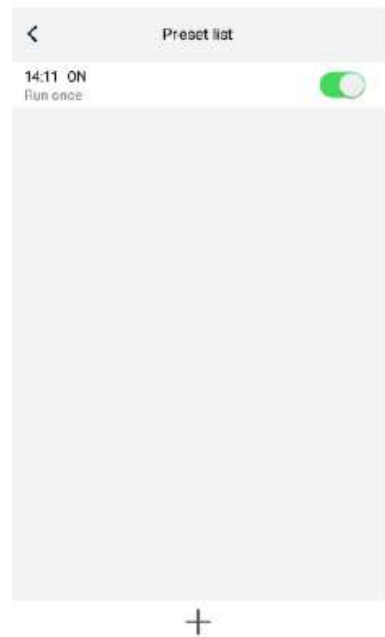
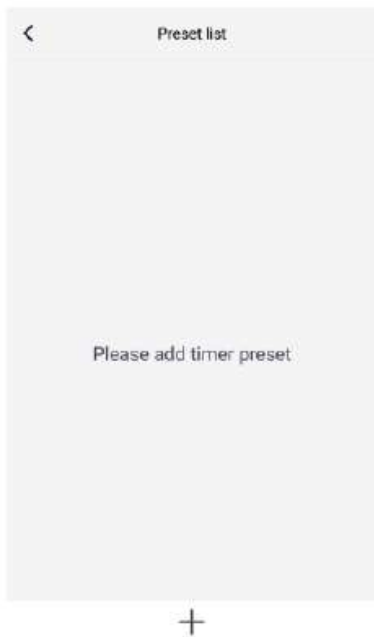

Other functions

1. Homepage menu

Click on the profile picture  in the upper left corner of the homepage and set each menu function.

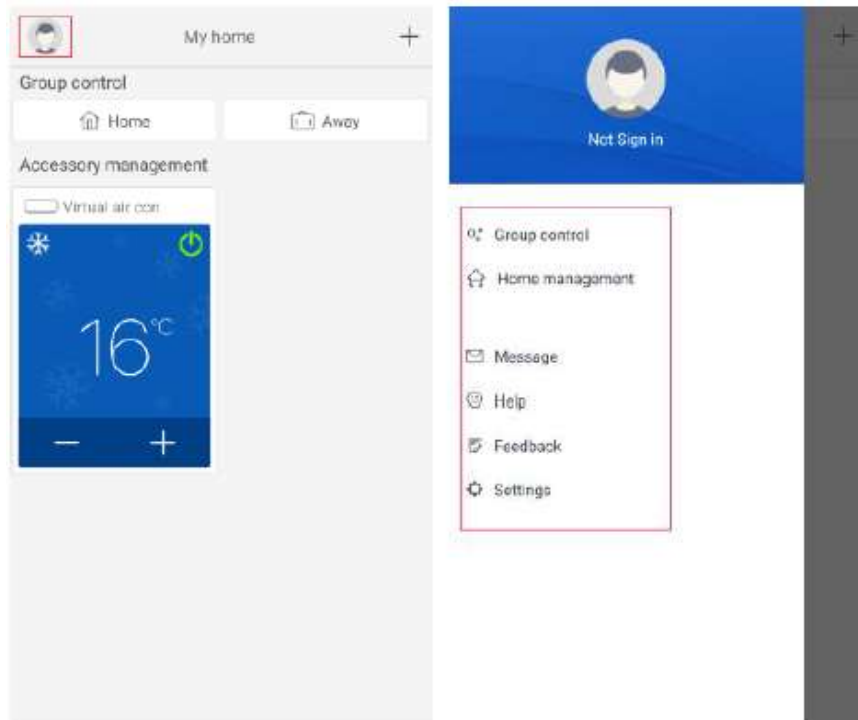

2. Group Control

Click Group Control to use the present devices (Ex. Change the group name to "hhh" and set up the devices in the group list). When this group is working you can change the settings of the whole group.

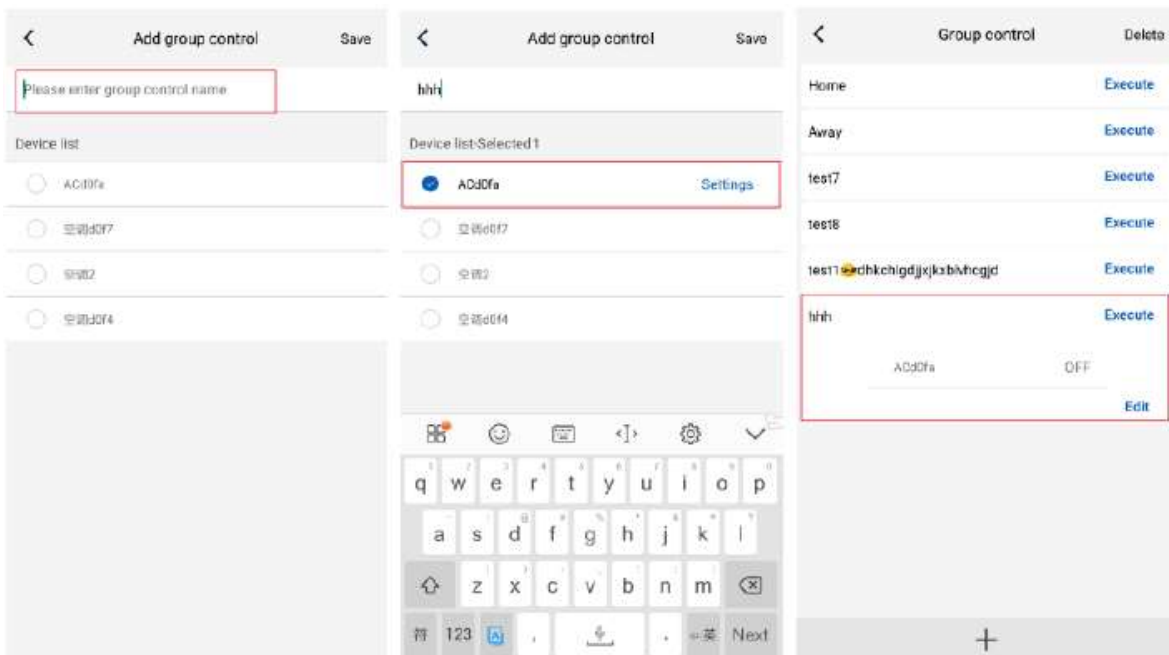

3. Home Management

Click Home Management to create or manage a "family system". You can add new members to the family system of the registered account.

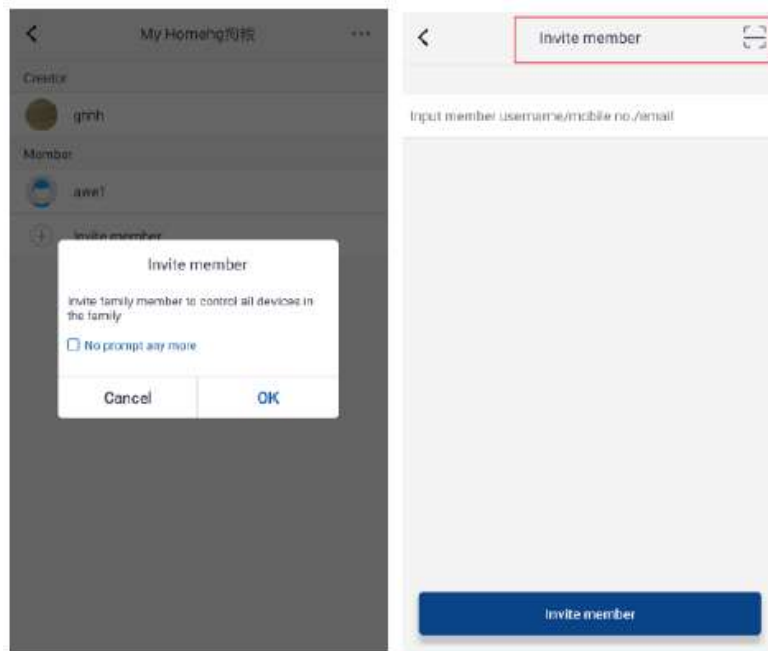
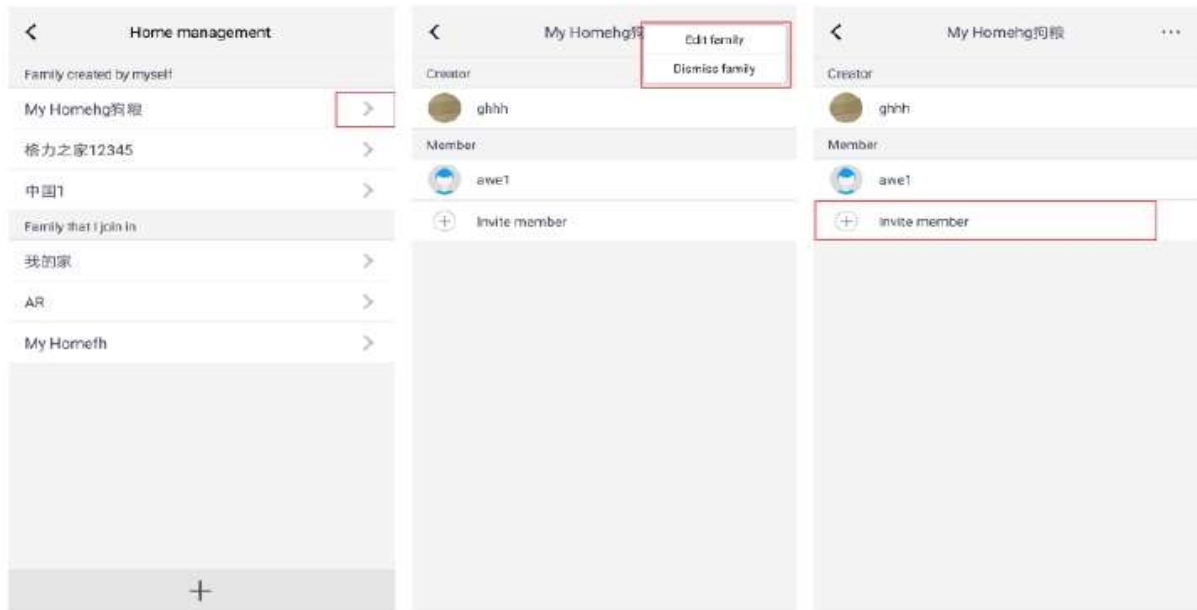

4. Help

Press Help to view the instructions for **EWPE SMART APP**.

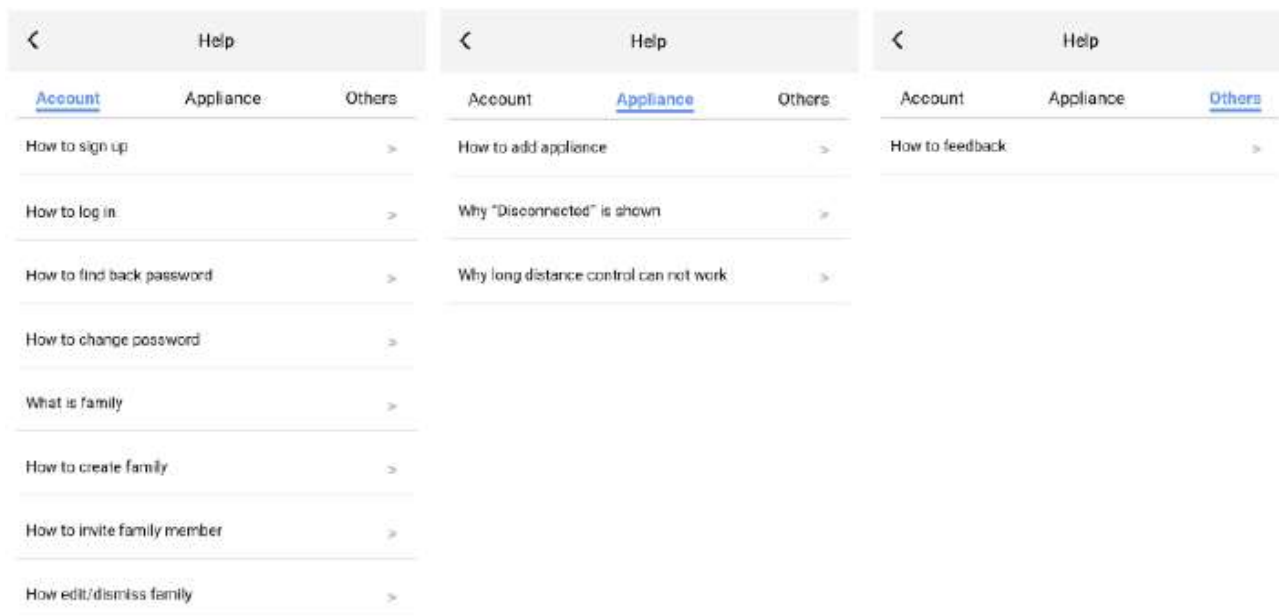

5. Feedback

Click Feedback to send a feedback on the product.

6. How to reset the air conditioner WiFi module:

Turn off the unit with the remote control and disconnect the air conditioner power for at least 10 seconds. Reconnect the power supply. After 1 minute, press the "WiFi" and "Mode" buttons simultaneously. If the air conditioner beeps, it means that the WiFi module has been reset correctly.

Attention: The configuration is carried out within 2 minutes. If it does not happen within 2 minutes, repeat the reset operation.

Analysis of common network setting errors:

If the short distance control does not work, perform the checks specified below:

- Make sure the air conditioner power is connected.
- Make sure that the air conditioner's WiFi function is normally active.
- Make sure your phone's WiFi selects the corresponding air conditioner.
- Reset with the remote control and restart the setting from step 3.

It is important to remember what is listed below.

1. The WiFi function of the air conditioner takes about 1 minute to start.
2. The air conditioner is equipped with memory function.

Google Home Instruction

1. Premise

Before using Google Home to control intelligent equipment, please make sure you have satisfied the following conditions.

- Your mobile phone has installed the latest version of Google Home app or Google app (for Android only)
- Your mobile phone has installed the latest version of EWPE app.

2. Complete device networking configuration according to the guidance of EWPE App

Note: Revise the device name in the App to the one which is easy for Google Assistant to recognize, it is English name generally, e.g: "Proklima Air conditioning".

3. Google Home configuration

- If you have configured Google Home, you can skip this step, the following statement is mainly for the Android client.
- Please make sure your Google Home device is energized and connected to Wi-Fi network, the four lights on the cover is on.
- Open Google Home App on the phone, after successful login, "Discover" will appear automatically to wait for the Google device to be connected.
- Click "Setup" to start connecting Google Home device.

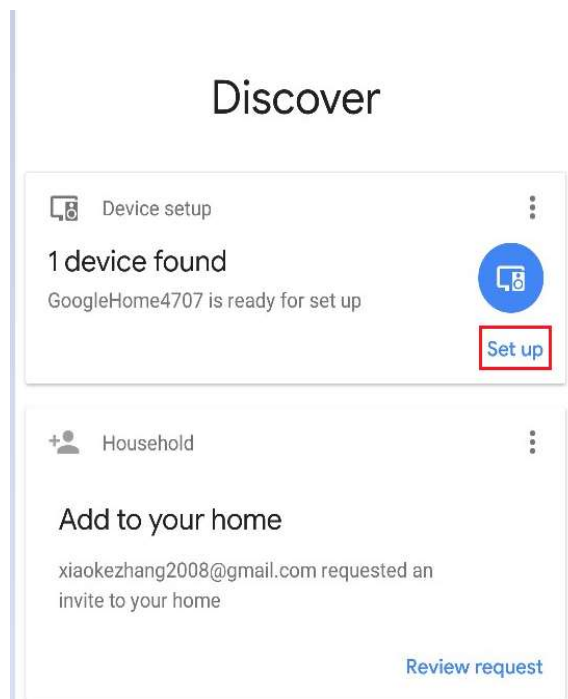

Confirm to add Google Home device and click "Yes".

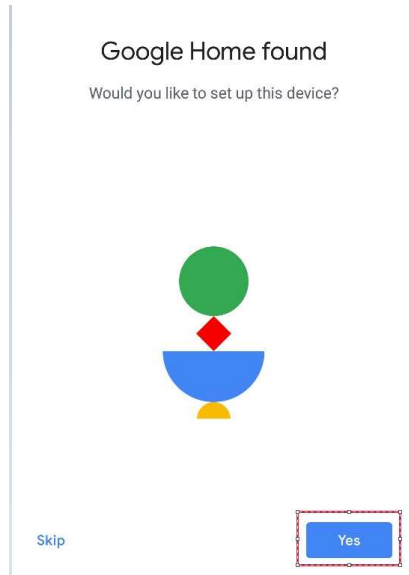

It will give out a sound to confirm that you have connected to the right device. After hearing the sound, click "Yes" to enter the next step.

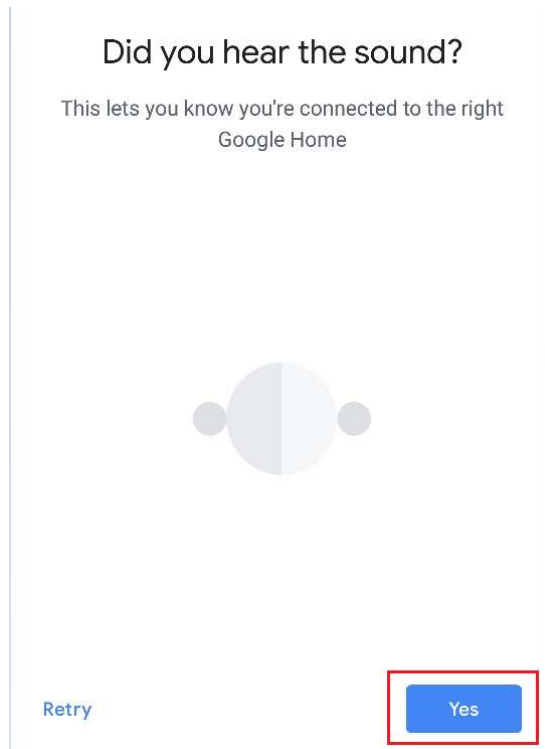

Join in Help Improve Google Home and click "Yes, I'm in" or "No thanks".

Help improve Google Home

Automatically share device stats and crash reports with Google to improve everyone's experience.

[Learn more](#)



[No thanks](#) [Yes, I'm in](#)

Distinguish the room of Google Home from the other Google device areas, click "NEXT", revise room name and click "Continue".

Where is this device?

Choose a location for your Google Home. This will help name and organize your devices.

My rooms

- 3783
- Attic

Create new

- Attic**
- Backyard

[Next](#)

Custom room name

Enter a name for this room. This will be added to your room list

Custom room name

Attic 2

[Continue](#)

Then select Wi-Fi network and click "NEXT" to wait for device network connection.

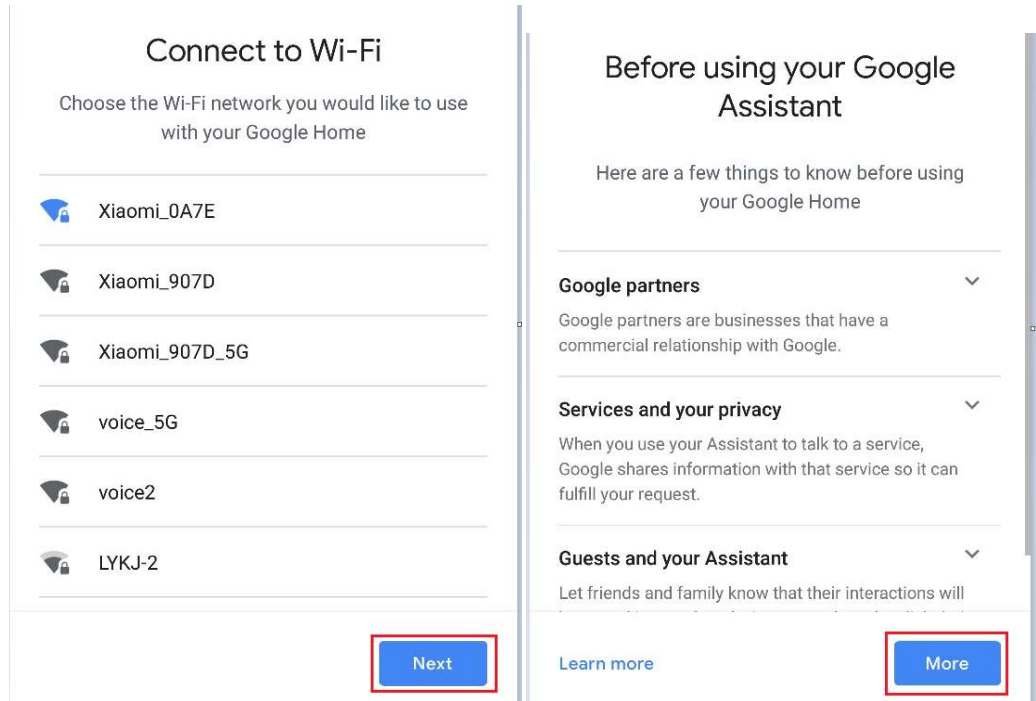

Set Google Home and click "More".

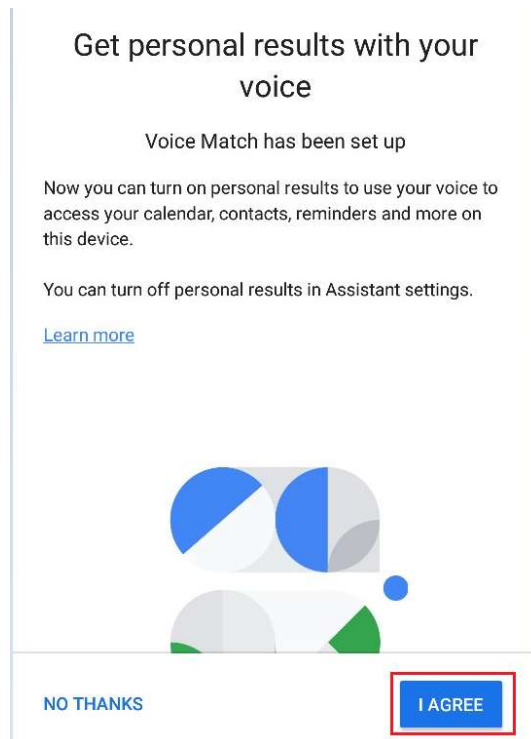

Click "I AGREE".

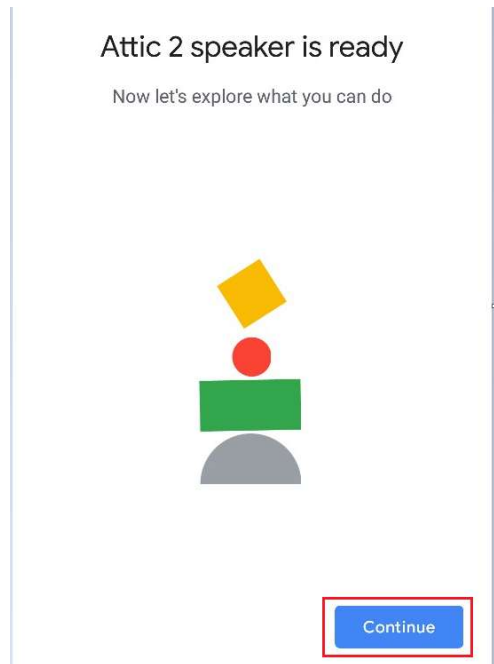

According to the prompting, choose if you agree the corresponding operation, if it displays "Google Home is ready", choose "Continue" to the next step.

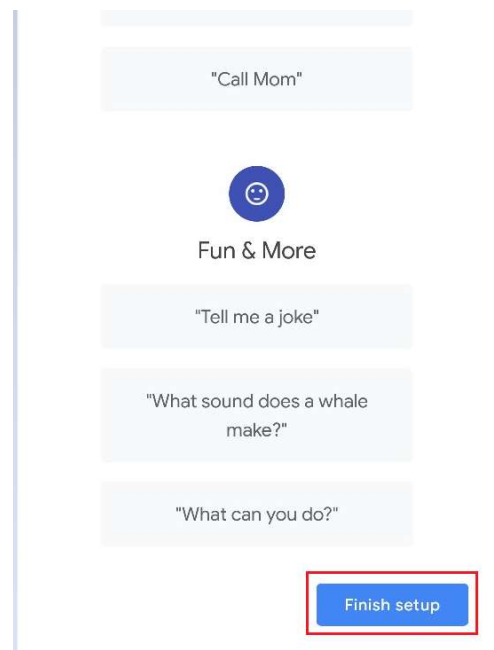

Here comes the language control guidance course, after listening, click "Finish setup", then Google Home setting is completed.

4. Add EWPE app account

- ◆ In Google Home App homepage, click “+” button.

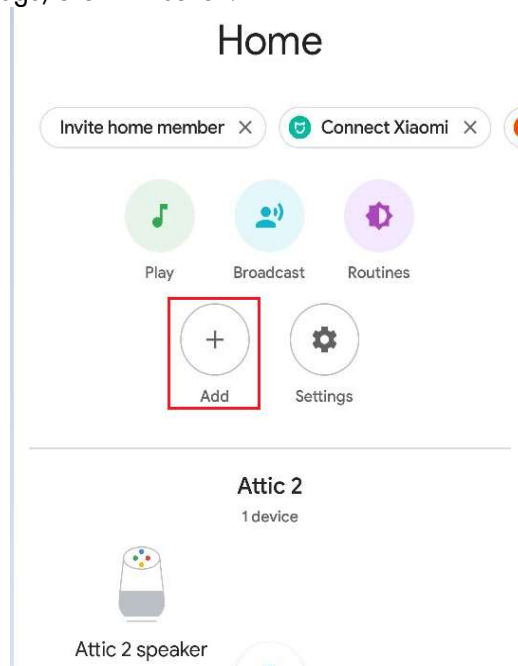

Click “Set up device”.

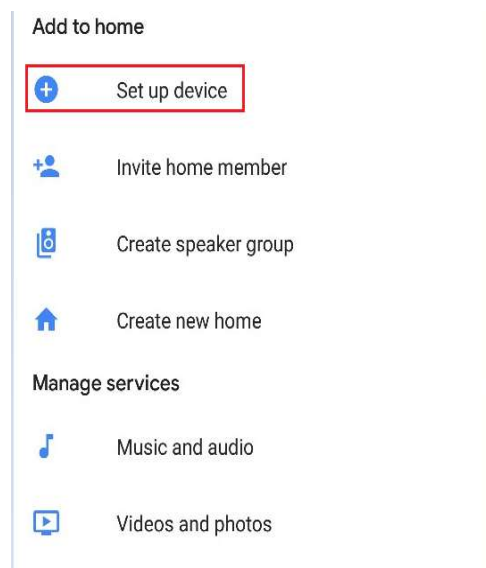

Select Works with Google.

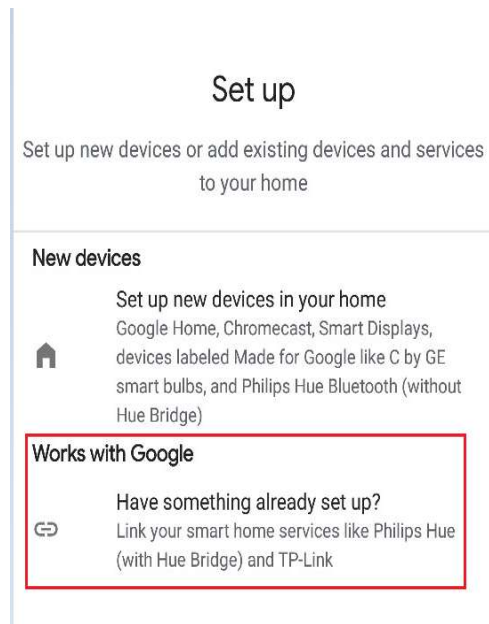

Search "Ewpe SmartHome".

Search Ewpe SmartHome on the list and click it, choose the country where your Ewpe Smart App account is, input EWPE App account and password and click "Ewpe SmartHome" to add it.

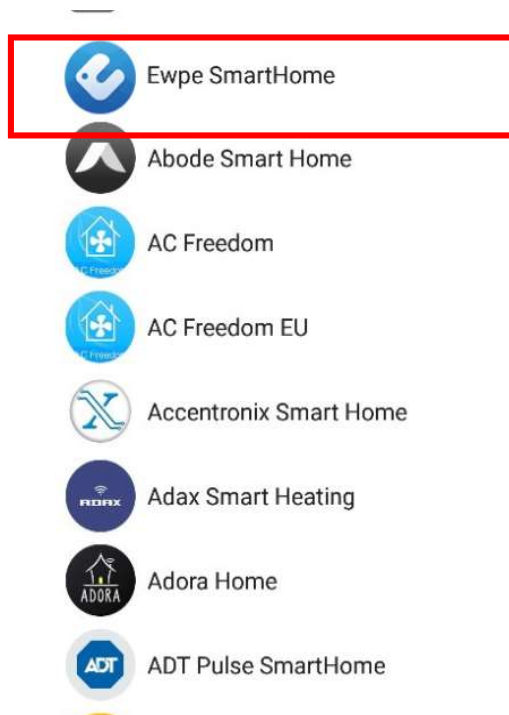

After adding, your device will appear on the device list.

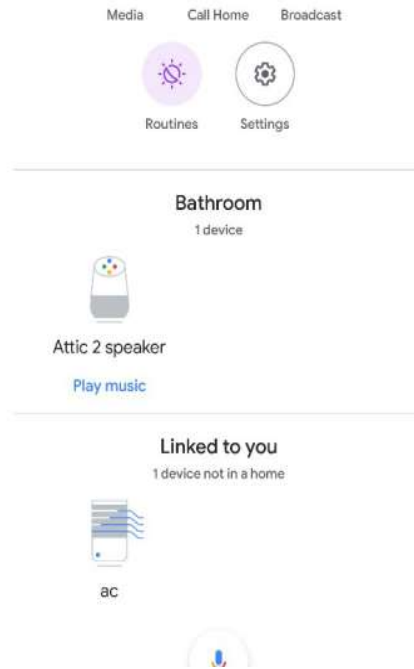

5. Use Google Home to control your intelligent device

Now, you can use Google Home to control your intelligent device.

Take Air Conditioning as an example, the supporting instruction includes:

Ok Google, turn on/off Air Conditioning.

AIR SPEED

Ok Google, set the air conditioning to high speed.

Mode

Ok Google, set the AC mode to cool.

Temperature

Ok Google, set the temperature at 16°C.

Emergency operation

In the event of loss or failure of the remote control, use the emergency button located under the indoor unit's front panel to turn the air conditioner on or off.

The unit will operate in automatic mode on start-up.

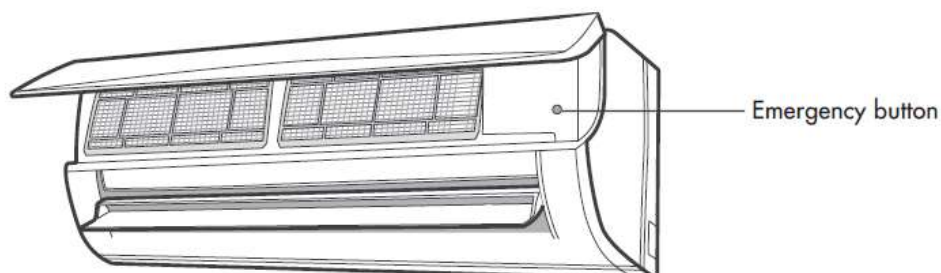

MAINTENANCE

Care and cleaning

N.B.:

Disconnect the power before servicing or cleaning the unit.

Cleaning the casing of the indoor unit

Use a soft, damp cloth to clean the outer surface of the unit.

Do not use water that is too hot, solvents, petrol or other aggressive chemical compounds, talcum powder or brushes. These may damage the colour or surface of the casing.

To remove stains, use warm water with a little neutral detergent.

Do not pour water onto the air conditioner to clean it. This may damage the internal components or cause a short circuit.

N.B.: Do not remove the panel when cleaning the unit.

Cleaning the filters

Open the panel

Lift the front panel of the indoor unit, as shown.

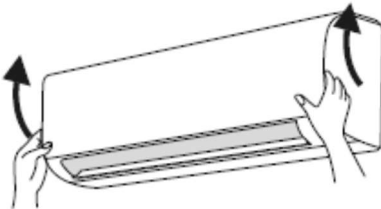

Remove the filters

Remove the filters by lifting one of the bottom corners and pulling them downwards, as shown.

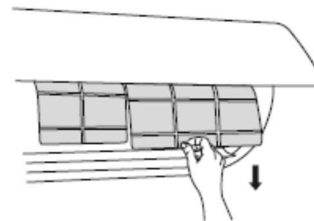

Clean the filters

- Use a vacuum cleaner to clean the filters.
- If they are very dirty, use water (below 45°C) and leave to dry in a cool, dark place.

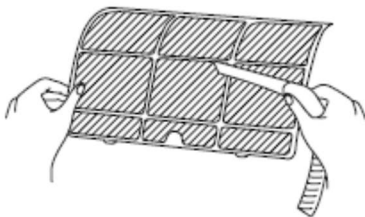

Refit the filters

Refit the filters and close the front panel.

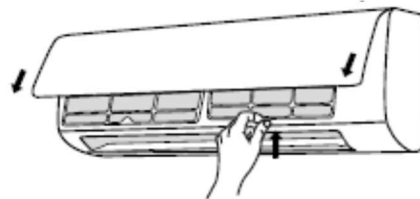

N.B.:

- The filters should be cleaned every three months, or more frequently if the room is very dusty.

WARNING!

When you remove the filters, avoid contact with the heat exchanger (there is a risk of cuts or abrasion).

- Do not use a hairdryer to dry the filters; the heat can cause damage and warping.

Before-use checks

1. Check that the air inlet and outlet are free of obstructions.
2. Check that the circuit breaker, plug and socket are in good working order.
3. Check that the filters are clean.
4. Check that the outdoor unit's support bracket is not damaged or corroded. If it is, contact the service centre.
5. Check that the piping is not damaged.

After-use checks

1. Disconnect the power supply.
2. Clean the indoor unit's panel and filters.
3. Check that the outdoor unit's support bracket is not damaged or corroded. If it is, contact the service centre.

N.B.

1. Many packaging materials are recyclable materials. Please dispose of them in the appropriate recycling unit.
2. If you want to remove the air conditioner, please contact your local dealer or local service provider for the correct disposal method.

TROUBLESHOOTING

Possible faults and solutions

WARNING

Do not attempt to repair the unit yourself. Improper repair can cause electric shocks or fire. Disconnect the unit from the power supply before contacting your local Technical Service Centre.

Carry out the following checks before contacting your Technical Service Centre:

Fault	Check	Solution
The indoor unit does not receive the signal from remote control or the remote control does not seem to be working	Is there noticeable interference (e.g. static electricity, stable voltage)?	Pull out the plug. After about 3 minutes reinsert the plug and restart the unit.
	Is the remote control within the signal reception range? Are there any obstacles between the remote control and the receiver?	The maximum signal reception distance is 8 m. The remote control will not work beyond this distance. Remove the obstacles.
	Is the remote control pointed at the receiver?	Point the remote control at the receiver on the indoor unit.
	Is the remote control's sensitivity low? Are icons blurred or missing?	Check the batteries. If the batteries are very low, replace them.
	Do icons fail to appear on the display when you operate the remote control?	Check if the remote control is damaged. If it is, replace it.
	Is there a fluorescent light in the room?	Position the remote control next to the indoor unit. Turn off the fluorescent light and try again.
	No air comes out of the indoor unit	Is the indoor unit's air inlet or outlet blocked?
In heat mode, has the indoor temperature reached the set temperature?		Once the set temperature has been reached, the indoor unit will stop blowing out air.
Has heat mode only recently been selected?		To prevent blasts of cold air from being blown out, there will be a delay of several minutes before operation begins (this is normal).
The air conditioner is not working	Is there a power cut?	Wait for the power to be restored.
	Has the plug come loose?	Reinsert the plug.
	Has the circuit breaker tripped or has the fuse blown?	Have the circuit breaker or fuse replaced by a qualified technician.
	Is the wiring faulty?	Have it replaced by a qualified technician.

	Was the unit restarted immediately after shutdown?	Wait 3 minutes and then restart the unit.
	Is the setting on the remote control correct?	Reset the function.
The indoor unit's air outlet produces a mist	Is the indoor temperature and humidity high?	Indoor air cools rapidly. Wait for the indoor temperature and humidity to fall and the mist to disappear.
The set temperature cannot be adjusted	Is the unit operating in automatic mode?	The temperature cannot be adjusted in automatic mode. Change the operating mode if you want to adjust the temperature.
	Does the desired temperature fall outside the available temperature range?	The available temperature range is: 16 – 30°C.
The desired level of heating/cooling cannot be achieved	Is the voltage too low?	Wait for the voltage to return to normal.
	Is the filter dirty?	Clean the filter.
	Does the set temperature fall within the available temperature range?	Adjust the temperature to within the available range.
	Are there any doors or windows open?	Close any doors and windows.
The unit is emitting unpleasant smells	Is there an odour source (e.g. furniture, cigarettes, etc.)?	Eliminate the odour source. Clean the filter.
The air conditioner turns on suddenly	Are there any sources of interference (e.g. lightning, wireless devices, etc.)?	Disconnect the power supply and then reconnect it. Turn the unit on again.
The outdoor unit produces steam	Has heat mode been selected?	Steam production when defrosting in heat mode is a normal phenomenon.
Sound of running water	Has the air conditioner recently been turned on or off?	The noise is produced by the refrigerant flowing inside the unit (normal phenomenon).
Creaking/cracking noises	Has the air conditioner recently been turned on or off?	It is the sound of the friction caused by the expansion and/or contraction of the panel or other parts due to temperature changes.

Analysing faults and solutions

Error codes

In the event of a fault, the temperature indicator on the indoor unit will flash to display the corresponding error code. Refer to the following list to identify the error code.

Error code	Faults and solutions
E5	Can be eliminated by turning the unit off and on again. Otherwise, contact a qualified technician for assistance.
E6	Can be eliminated by turning the unit off and on again. Otherwise, contact a qualified technician for assistance.
U8	Can be eliminated by turning the unit off and on again. Otherwise, contact a qualified technician for assistance.
E8	Can be eliminated by turning the unit off and on again. Otherwise, contact a qualified technician for assistance.
C5	Contact a qualified technician for assistance.
F0	Contact a qualified technician for assistance.
F1	Contact a qualified technician for assistance.
F2	Contact a qualified technician for assistance.
H3	It can be eliminated switching off the unit and switching it back on. If this doesn't work contact a qualified technician to assist.
H6	It can be eliminated switching off the unit and switching it back on. If this doesn't work contact a qualified technician to assist.
E1	It can be eliminated switching off the unit and switching it back on. If this doesn't work contact a qualified technician to assist.

N.B.: In the event of other error codes, contact a qualified technician for assistance.

Warning

If you experience any of the following problems, turn the air conditioner off and immediately disconnect the power. Then contact your local Technical Service Centre.

- The power cable is damaged or has overheated.
- The unit makes an unusual noise during operation.
- The circuit breaker keeps tripping.
- The air conditioner emits a burning smell.
- The indoor unit is leaking.
- Do not attempt to repair or reinstall the air conditioner yourself.
- If the air conditioner is operated in abnormal conditions, malfunction, electric shock or fire may result.

INSTALLATION INSTRUCTIONS

Installation diagrams

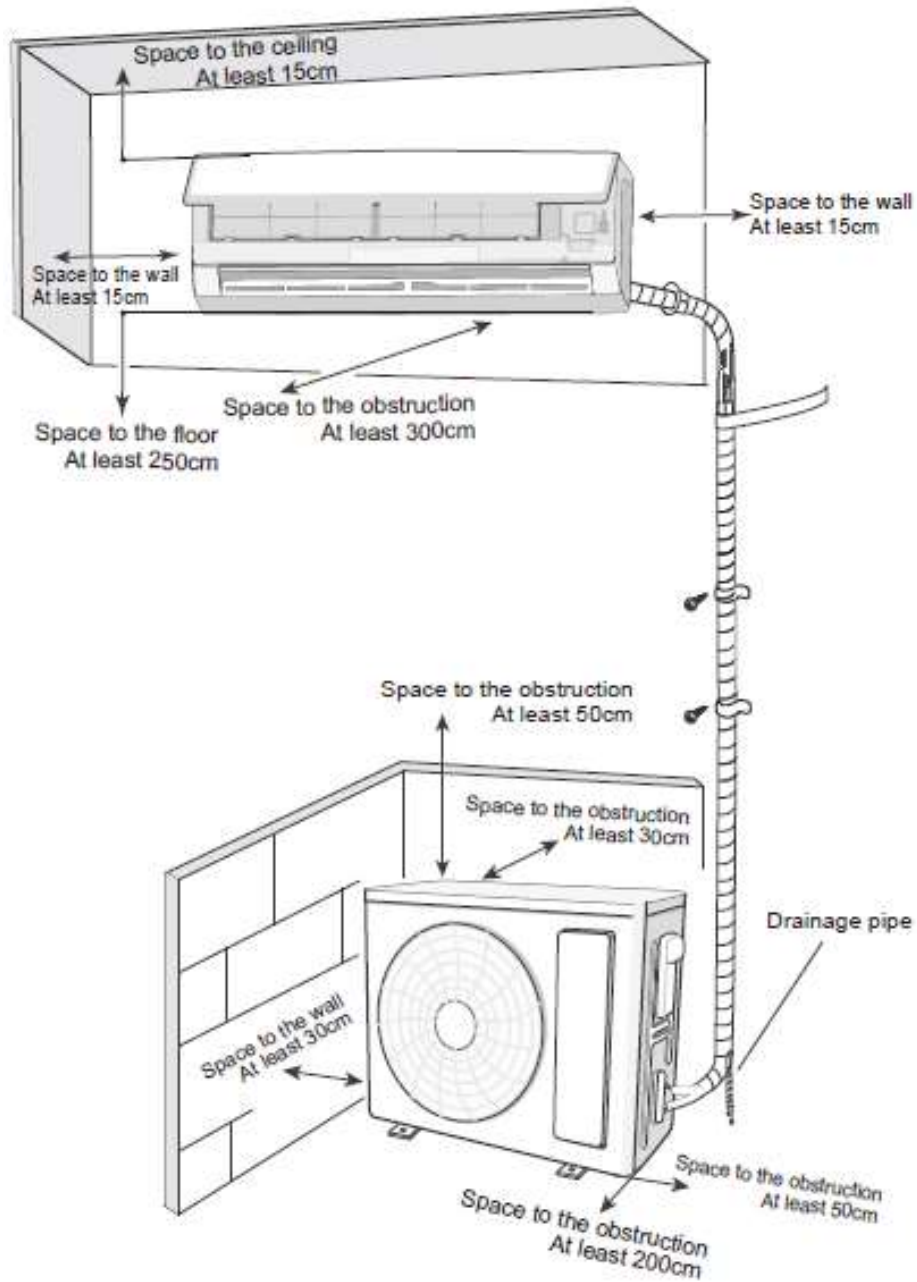

INSTALLATION WARNINGS

WARNING: Make sure that the power supply is disconnected before carrying out any work on the unit.

WARNING: Wear appropriate personal protective equipment before carrying out any work on the unit.

WARNING: The appliance must be reinstalled in accordance with national system regulations.

WARNING: Wiring and installation must only be performed by a qualified technician trained to install, modify, extend and service the unit and perform safety and functionality tests.

WARNING: Install a device, master switch or electric plug that will allow all the power from the appliance to be switched off.

The following information is essential for correct unit installation. However, the installer should use his or her experience to install the unit according to specific requirements.

Do not install the unit in locations where there are flammable gases or acid or alkaline substances that may irreparably damage the copper-aluminium heat exchangers or internal plastic components.

Do not install the unit in offices or kitchens where oil vapours mixed with treated air may settle on the exchange coils, reducing performance, or on the unit's internal parts, damaging the plastic components.

ATTENTION: For the connection between the units, use only annealed and deoxidized copper pipe for conditioning and refrigeration and insulated with expanded polyethylene of min. 8 mm.

Choosing a location for installation

Essential requirements	Indoor unit
<p>Do not install the unit in the following locations. Otherwise, a fault may occur.</p> <ol style="list-style-type: none"> Locations with extreme heat sources or flammable or explosive gases or vapours. Locations with high-frequency devices (e.g. welding machines, medical equipment). Locations close to coastal areas. Locations with oils or fumes in the air. Locations with sulphide gas. Other locations that have special conditions. <p>Do not operate the unit in the immediate vicinity of laundrettes, bathtubs, showers or swimming pools.</p>	<ol style="list-style-type: none"> There should be no obstructions near the air inlet or outlet. Choose a location where the condensate can drain out easily without causing a nuisance. Choose a convenient location to connect the outdoor unit to the power outlet. Choose a location out of the reach of children. The site should be strong and solid enough to support the weight of the indoor unit and prevent noise or vibration. The unit should be installed 2.5 m from the floor. Do not install the indoor unit directly above electrical equipment. Try to keep a certain distance from fluorescent lights.
Outdoor unit	<ol style="list-style-type: none"> Choose a location where the noise and airflow produced by the outdoor unit will not annoy neighbours. The location should be well ventilated and dry; the outdoor unit must not be exposed to direct sunlight or strong winds. The site should be able to support the weight of the outdoor unit. Check that the installation complies with the requirements of the dimensional drawing for installation. Choose a location out of the reach of children and away from animals or plants. If this is not possible, install safety fencing.

Electrical connection requirements

Safety precautions

1. Electrical safety standards must be met when installing the unit.
2. Use a power supply circuit and circuit breaker that comply with local safety regulations.
3. Make sure that the power supply matches the requirements of the air conditioner. An unstable power supply or incorrect wiring may result in a fault. Install suitable power cables before switching on the air conditioner.
4. Correctly connect the live, neutral and earth wires to the power outlet.
5. Disconnect the power supply before carrying out any work on the electrical circuit or carrying out any safety work. For models with a plug, make sure the plug is easily accessible after installation.
6. Do not connect the power before installation is complete.
7. Do not use the appliance if the power cable or plug are damaged. If the power cable is damaged it must be replaced by the manufacturer, retailer or other qualified person to avoid a hazard.
8. Since the temperature of the cooling circuit is high, keep the interconnecting cable away from the copper pipe.
9. The unit must be installed in accordance with national wiring regulations.
10. Installation must only be performed by trained individuals in accordance with regulations.



The unit is charged with a slightly inflammable refrigerant, R32. Improper handling of this gas may expose people and materials to serious damage. More details on this refrigerant are given at the beginning of this manual.

Earthing

1. The air conditioner is a Class I appliance. The unit must be earthed with an appropriate device by a qualified technician. Ensure the unit is always properly earthed. Otherwise electric shock may result.
2. The green-yellow wire of the air conditioner is the earthing wire and may not be used for other purposes.
3. The earth resistance must meet national standards for electrical safety.
4. The unit must be positioned so that the plug is accessible.
5. An all-pole isolating switch with a minimum contact gap of 3mm in each pole must be connected to the fixed cable.

Air-conditioner	Air switch capacity
09K、12K	10A
18K	16A
24K	25A

INSTALLATION

Indoor unit installation

Step one: choose of the position

Decide where to install the unit based on room design, architectural limitations and customer requirements. Check that in the selected location the unit can be accessed for servicing and cleaning the filters. To install, use the installation plate as a template to identify the exact position for the wall plugs and through-hole in the wall. The plastic casing has stoppers which if necessary can be removed to route the refrigerant lines and cables. When operating in cool or dry mode, the moisture in the air condenses on the coil of the indoor unit, collects in the basin and drains out through the special rubber hose. The hose must be connected to a pipe with a suitable gradient, ensuring no unnecessary bends are created. Do not run siphons and do not immerse in water.

Step two: mount the wall-installation plate

1. Position the installation plate on the wall. Use a level to position it horizontally and mark the holes for the bolts on the wall.
2. Drill the holes for the screws in the wall with a hammer drill (the drill bit must match the plastic wall plug). Then insert the wall plugs into the holes.
3. Secure the plate to the wall with the self-tapping screws (ST4.2X25TA). Check it is securely attached by pulling on the bracket. If a plastic wall plug is loose, drill another hole nearby with the hammer drill.

Step three: drill the hole for the piping

Select the position for the piping hole according to the direction of the outlet pipe. The piping hole must be slightly lower than the wall-installation frame, as shown below.

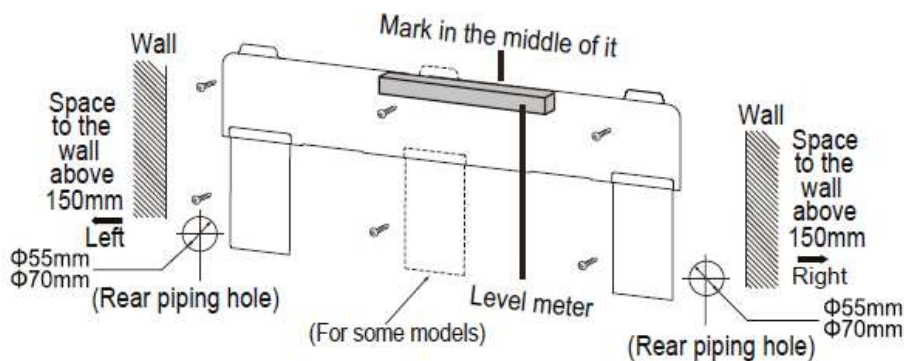

Drill a piping hole of diameter $\Phi 55$ at the chosen location for the outlet pipe. To allow for proper drainage, the piping hole in the wall must slant slightly downwards to the outdoor side, with a gradient of $5 - 10^\circ$.

N.B.:

- Take the necessary safety measures when drilling the hole and do not allow dust to enter.
- The plastic wall plugs are not supplied but must be purchased on site.

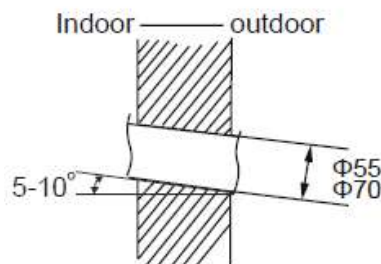

Step four: outlet pipe

The pipe can be brought out in various different directions: right, rear right, left or rear left.

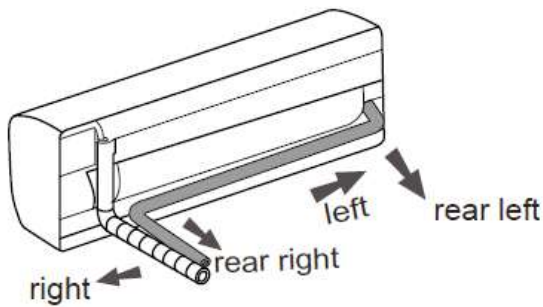

Once you have selected the direction of the outlet (left or right), drill the corresponding hole at the bottom.

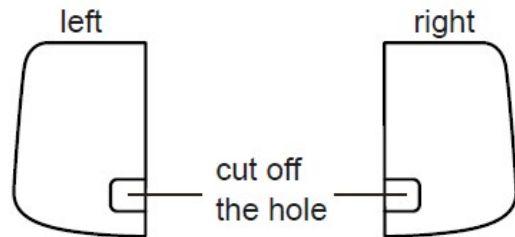

Step five: connect the indoor unit pipe

1. Position the pipe joint in the corresponding bellmouth.
2. Pre-tighten the union nut by hand.
3. Adjust the torque according to the following table. Position the open-end spanner on the pipe joint and position the torque wrench on the union nut. Tighten the nut with the wrench.

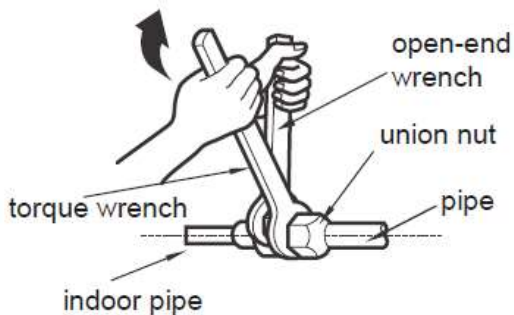
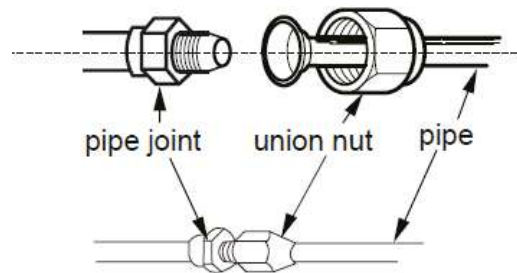

Hex nut diameter	Tightening torque (Nm)
$\Phi 6.35$	15 – 20
$\Phi 9.52$	30 – 40
$\Phi 12.7$	45 – 55
$\Phi 15.88$	60 – 65

Wrap the indoor pipe and the joint of the connecting pipe with an insulating tube. Then wrap with tape.

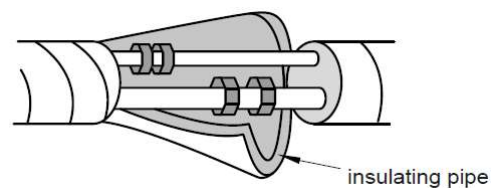

Step six: install the condensate drain pipe

1. Connect the drain pipe to the outlet pipe of the indoor unit.

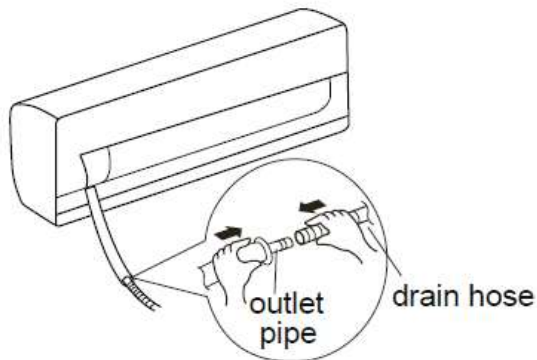

2. Bind the joint with tape.

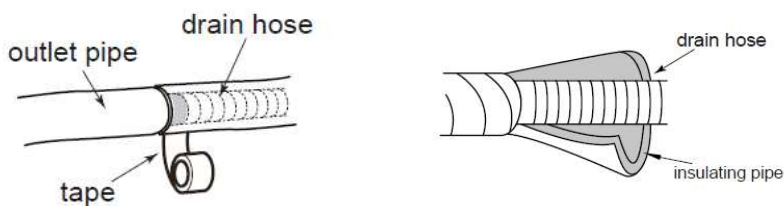

N.B.:

- Add an insulating tube to the indoor drain pipe to prevent condensation.
- The plastic wall plugs are not supplied.

Step seven: connect the indoor unit electrical cable

1. Open the panel. Remove the screw that secures the small panel covering the terminal board.
2. Insert the indoor and outdoor unit connecting cable into the rear hole corresponding to the terminal block. Then pull it out of the front.
3. Remove the cable clip. Connect the power cable to the terminal block according to colour. Tighten the screw and secure the power cable with the clip.

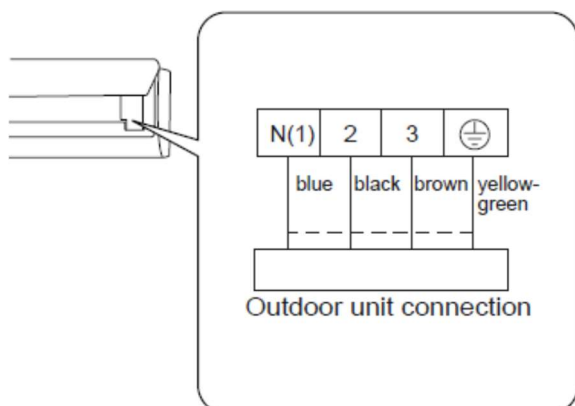
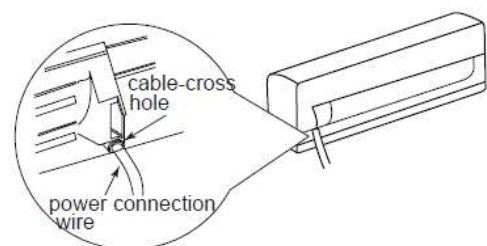
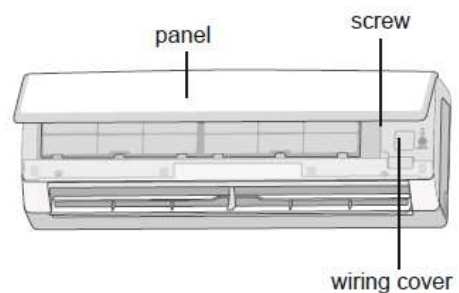

Note: the link card is only for reference, please take into consideration the actual one.

4. Reposition the terminal block cover and tighten the screws.
5. Close the panel.

N.B.:

- All wiring must be connected as shown on the unit's wiring diagram.
All indoor and outdoor unit cables must be connected by a qualified technician.
- If the power cable is not long enough, contact the supplier for a new one. Do not attempt to extend it yourself.
- For air conditioners equipped with a plug, the plug must be easily accessible upon completion of installation.
- For air conditioners without a plug, install a circuit breaker on the line. The circuit breaker must be single-pole and the contact gap must be greater than 3mm.

Step eight: bind the pipes

1. Bind together the connecting pipe, the power cable and the drain pipe with binding tape.

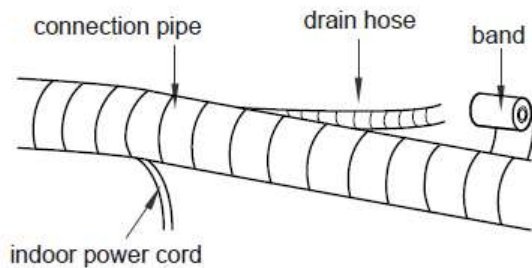
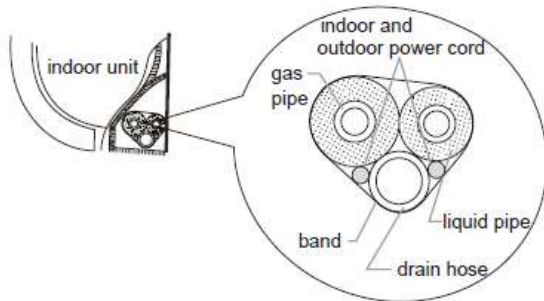

3. Bind them evenly.
4. The liquid pipe and gas pipe must be bound separately at the end.

2. Reserve a section of the drain pipe and power cable for installation when binding. When you have bound up to a certain point, separate the indoor power cable and then the drain pipe.

N.B.:

The power cable and signal control cable must not be rolled or coiled.
The drain pipe must be bound at the bottom.

Step nine: hang the indoor unit

1. Insert the bound pipes into the wall pipe and route them through the hole in the wall.
2. Hang the indoor unit on the wall-installation plate.
3. Fill the gap between the pipes and the hole in the wall with sealant.
4. Secure the wall pipe.
5. Check that the indoor unit is securely installed and flush against the wall.

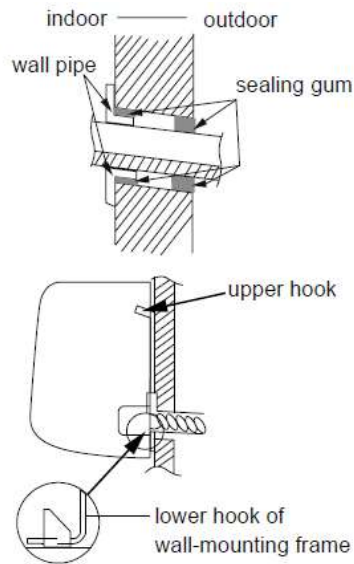

N.B.:

- Avoid bending the drain pipe too much in order to prevent clogging.

Outdoor unit installation

Step one: secure the outdoor unit support

1. Choose a location for the unit according to the structure of the house.
2. Use expansion screws to secure the outdoor unit support in the chosen position.

N.B.:

- Take the appropriate safety measures when installing the outdoor unit.
- Make sure that the bracket can support at least four times the weight of the unit.
- The outdoor unit must be connected at least 3 cm above the ground in order to install the drain joint.
- Units with a cooling capacity of 2300 W – 5000 W require 6 expansion screws; units with a cooling capacity of 6000 W – 8000 W require 8 expansion screws; units with a cooling capacity of 10000 W – 16000 W require 10 expansion screws.

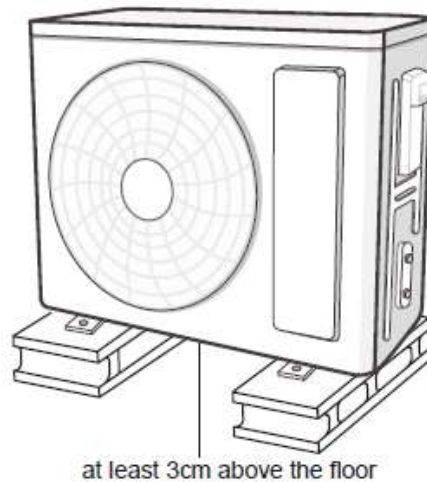

Step two: install the drain joint

1. Connect the outdoor drain joint into the hole on the chassis, as shown below.
2. Connect the drain hose into the drain hole.

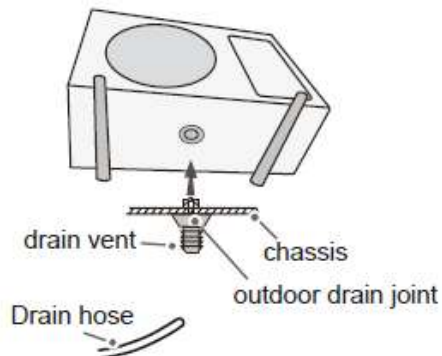

NB: As for the shape of drainage hose, please refer to the current product. Do not install the drainage hose in the severe cold area, otherwise it will be frosted and then cause malfunction.

Step three: secure the outdoor unit

1. Position the outdoor unit on the support.
2. Secure the foot holes of the outdoor unit with bolts.

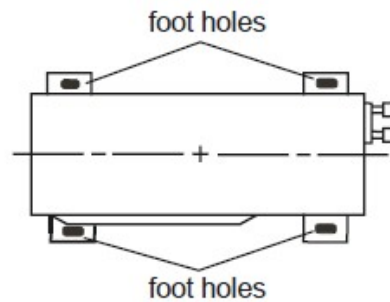

Step four: connect the indoor and outdoor pipes

1. Remove the screw on the right-hand handle of the outdoor unit and remove the handle.
3. Pre-tighten the union nut by hand.

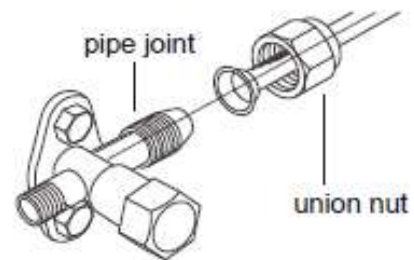
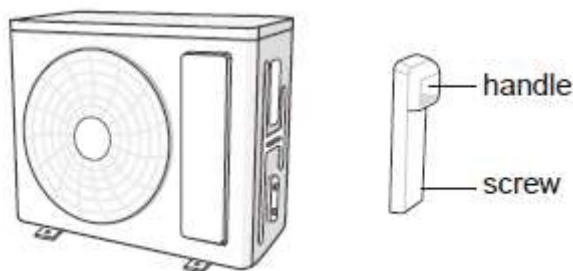

2. Remove the screw cap of the valve and position the pipe joint in the bellmouth of the pipe.

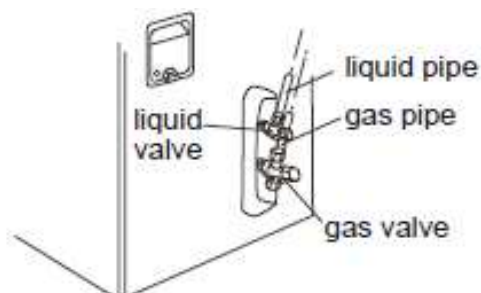

4. Tighten the union nut with the wrench according to the following table.

Hex nut diameter	Tightening torque (Nm)
Φ6.35	15 – 20
Φ9.52	30 – 40
Φ12.7	45 – 55
Φ15.88	60 – 65

Step five: connect the outdoor electrical cable

1. Remove the wire clip. Connect the power cable and the signal control cable (only for cooling and heating units) to the wiring terminal according to colour. Secure them with the screws.

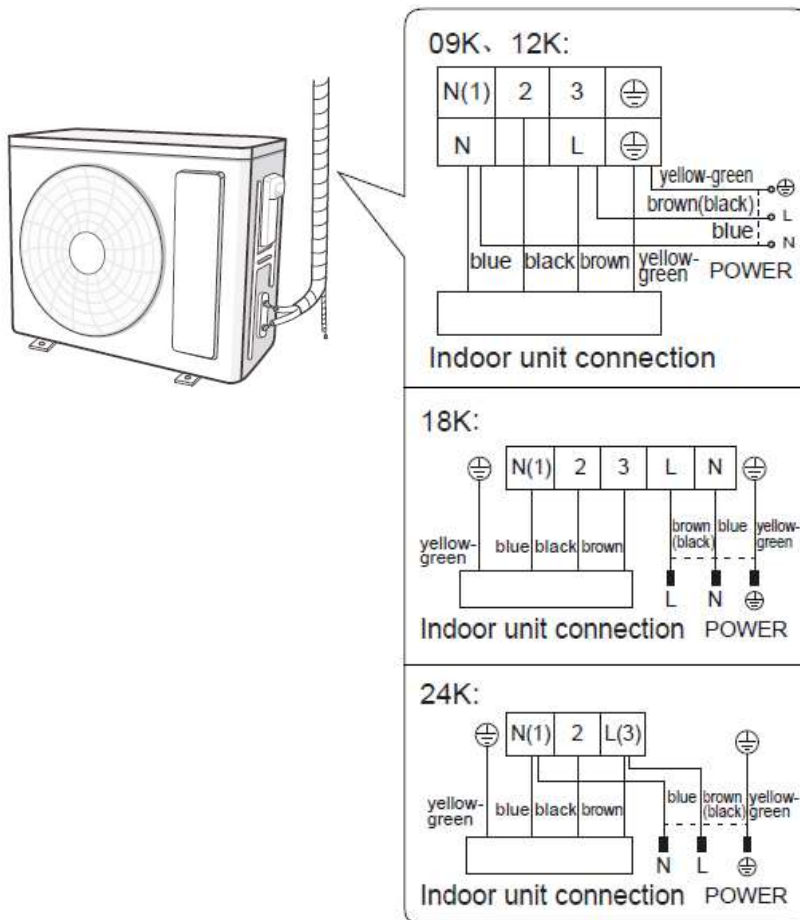

2. Secure the power cable and the signal control cable with the clip (only for cooling and heating units).

N.B.:

- Once you have tightened the screw, pull on the power cable gently to check it is secure.
- Never cut the power cable to extend or reduce the distance.

Step six: tidy up the pipes

1. The pipes should be routed along the wall, bent only as much as is necessary and, if possible, hidden from view. Minimum pipe bending radius: 10 cm.

2. If the outdoor unit is higher than the hole in the wall, you must create a U-bend in the pipe before it enters the room to prevent rain from getting into the room.

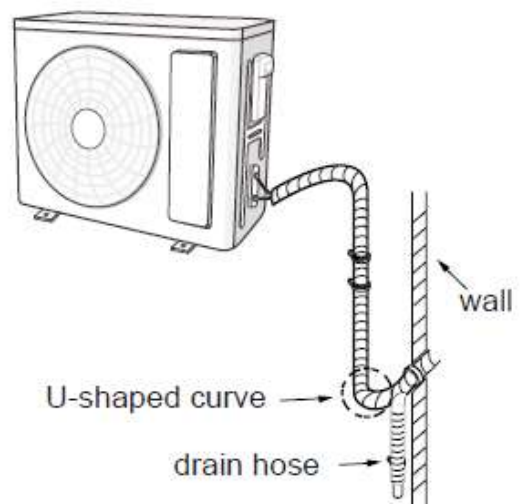

NOTICE

- The through-wall height of drain hose should not be higher than the outlet pipe hole of indoor unit.

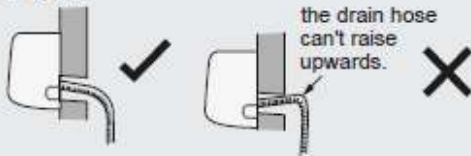

- The water outlet can't be placed in water in order to drain smoothly.

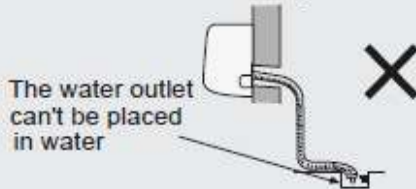

- Slant the drain hose slightly downwards. The drain hose can't be curved, raised and fluctuant, etc.



- The drain hose can't be fluctuant



Vacuum pump

Using the vacuum pump

- Remove the valve caps of the liquid valve and gas valve and remove the nut of the refrigerant charge port.
- Connect the piezometer charge pipe to the refrigerant charge bore of the gas valve. Then connect the other charge pipe to the vacuum pump.
- Open the piezometer completely and let it run for 10 – 15 minutes to check if the pressure of the piezometer remains at -0.1 MPa.
- Close the vacuum pump and maintain this condition for 1 – 2 minutes to check if the pressure of the piezometer remains at -0.1 MPa. If the pressure falls, there may be a leak.

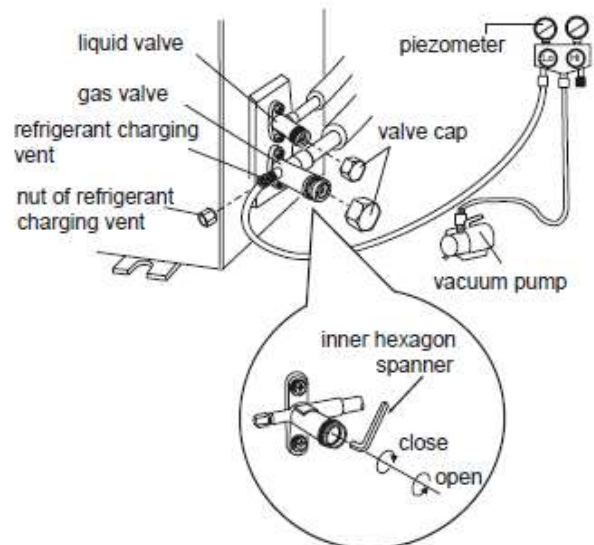

- Remove the piezometer. Fully open the plunger of the liquid valve and gas valve with the inner hex key.
- Tighten the screw caps of the valves and refrigerant charge port.
- Reinstall the handle.

Leak detection

Check for leaks using a leak detector. If you do not have a leak detector you can use soapy water.

Post-installation checks

Checks	Possible fault
Has the unit been installed securely?	The unit could fall, move or produce excessive noise.
Has the leakage test of the refrigerant been done?	Risk of condensation and dripping water.
Is the thermal insulation of the pipes sufficient?	Risk of condensation and dripping water.
Does the water drain properly?	Risk of condensation and dripping water.
Does the supply voltage match the voltage indicated on the data plate?	Risk of malfunction or damage to components.
Have the piping and electrical wiring been installed correctly?	Risk of malfunction or damage to components.
Has the unit been properly earthed?	Risk of electric leakage.
Does the power cable meet requirements?	Risk of malfunction or damage to components.
Are there any obstructions at the air inlet or outlet?	The cooling (heating) capacity may be insufficient.
Have the dust and other particles produced during installation been removed?	Risk of malfunction or damage to components.
Are the gas valve and liquid valve of the connecting tube fully open?	The cooling (heating) capacity may be insufficient.
The entrance and exit of the pipe holes have been covered?	Risk of condensation and dripping water.

TESTING AND OPERATION

Functional testing

Connect the power and press the ON/OFF button on the remote control to start operation. Press the MODE button to select AUTO, COOL, DRY, FAN and HEAT mode and check the air conditioner operates normally.

If the ambient temperature is below 16°C, the air conditioner will be unable to start cooling.

APPENDICES

Piping configuration

1. Standard connecting tube length: 5 m.
2. Minimum connecting tube length: 3 m.
3. Maximum connecting tube length and maximum height difference:

Capacity	Maximum connecting tube - length	Maximum height difference
9000 Btu/h	15	10
12000 Btu/h	15	10
18000Btu/h	25	10
24000Btu/h	25	10

Warning! Note the additional charge on the data plate affixed to the outdoor unit.

Additional oil and refrigerant charging

- If the length of the connecting pipe is increased by 10 m compared to the standard length, add 5 ml of refrigeration oil for every 5 m of pipe added.
- Method for calculating the amount of additional refrigerant charge (liquid pipe): amount of additional refrigerant charge = additional length of liquid pipe x additional amount of refrigerant charge per metre.

	Connecting pipe diameter		Additional refrigerant
	Liquid pipe (mm)	Gas pipe (mm)	(g/m)
9-12 K	Φ 6,35	Φ 9,52	16
18 K	Φ 6,35	Φ 12,7	16
24 K	Φ 6,35	Φ 15,88	16

Safety operation of flammable refrigerant

Qualification requirement for installation and maintenance

- All workers who engage with the refrigeration system should bear the valid certification awarded by the authoritative organization, and the qualification recognized by the industry for dealing with the refrigeration system.
- The refrigeration system can only be repaired following the methods suggested by the equipment's manufacturer.

Installation notes

- The air conditioner mustn't be used in a room that has running fire or heat sources (such as, working coal gas ware, operating heater).
- Do not drill holes in the circuit or burn the connection pipe.

- The air conditioner must be installed in a room that is larger than the minimum room area. The minimum room area is shown on the following “table a”.
- Leak test is mandatory after installation.

table a - Minimum room area (m ²)

Minimum room area(m ²)	Charge amount (kg)	≤1.2	1.3	1.4	1.5	1.6	1.7	1.8	1.9	2	2.1	2.2	2.3	2.4	2.5
	floor location	/	14.5	16.8	19.3	22	24.8	27.8	31	34.3	37.8	41.5	45.4	49.4	53.6
	window mounted	/	5.2	6.1	7	7.9	8.9	10	11.2	12.4	13.6	15	16.3	17.8	19.3
	wall mounted	/	1.6	1.9	2.1	2.4	2.8	3.1	3.4	3.8	4.2	4.6	5	5.5	6
	ceiling mounted	/	1.1	1.3	1.4	1.6	1.8	2.1	2.3	2.6	2.8	3.1	3.4	3.7	4

Maintenance notes

- Check whether the maintenance area or the room area meet the requirement of “table a” - the unit is only allowed to be operated in rooms that meet these requirements.
- Check whether the maintenance area is well-ventilated. - The continuous ventilation status should be kept during the entire operation process.
- Check whether there is a fire source or potential fire source in the maintenance area. Running fire is prohibited in the maintenance area and the “no smoking” sign should be hanged.
- Check whether the warning sign is in good condition, otherwise replace it.

Welding

- If it is necessary to cut or weld the refrigerant system pipes in the maintenance procedures, please follow the steps here below:
 - a. Shut down the unit and cut power supply
 - b. Eliminate the refrigerant
 - c. Vacuum with a vacuum machine
 - d. Clean the pipes with the N2 gas
 - e. Cut and weld or
 - f. Bring the unit to a service centre for welding
- The refrigerant should be recycled in a specialized storage tank.
- Make sure there aren't any free flames near the outlet of the vacuum pump and that it's well-ventilated.

Filling the refrigerator circuit

- Use refrigerant filling appliances specialized for R32. Make sure that different kinds of refrigerant don't contaminate one another.
- The refrigerant tank should be kept upright when filling with the refrigerant.
- Stick the label on the system after filling is finished.
- Don't overfill.
- After filling is finished, please test the unit for leakage detection before the operation test; another test for leakage detection should be carried out when the refrigerant is removed.

Safety instructions for transportation and storage

- Please use a flammable gas detector to check before unloading and opening the container.
- No fire source and no-smoking.
- According to the local rules and laws

Procedure for extending the piping

N.B.:

Improper extension of piping is the main cause of refrigerant leaks. Proceed as shown below:

1. Cut the pipe

- Check the length of the pipe based on the distance between the indoor unit and outdoor unit.
- Cut the required pipe using a pipe cutter.

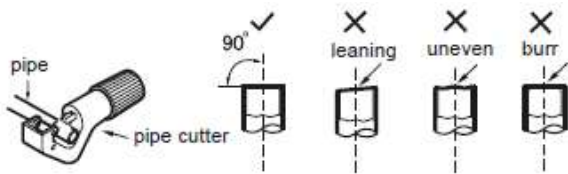

5. Expand the port

Expand the port using a pipe expander.

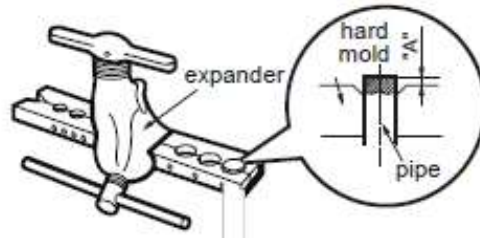

2. Remove burrs

- Remove burrs with a file, ensuring they do not go into the pipe.

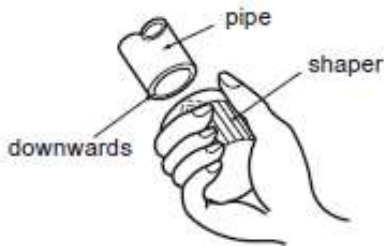

N.B.:

- "A" varies according to diameter:

Outdoor diameter (mm)	A (mm)	
	Max.	Min.
6.35 (1/4")	1.3	0.7
9.52 (3/8")	1.6	1.0
12.7 (1/2")	1.8	1.0
15.88 (5/8")	2.4	2.2

3. Secure an insulating tube

4. Install a union nut

- Remove the union nut on the indoor connecting pipe and outdoor valve. Install the union nut on the pipe.

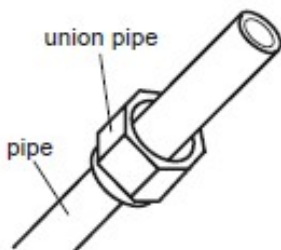

6. Inspection

Check the quality of the expanded port. If defective, expand the port again following the procedure described above.

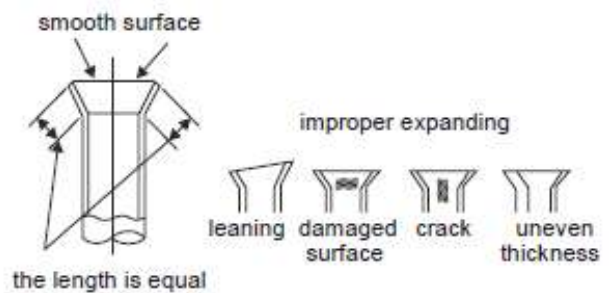

Warnings for the refrigeration system specialist

Here are warnings and safety instructions for the maintenance of systems containing flammable refrigerant (repairs should only be carried out by specialists).

a) Any person involved in the work or in the interruption of a refrigeration circuit must be equipped with PEF (European Refrigerators License) as required by the D.P.R. n. 146/2018 implementing Regulation (EU) no. 517/2014.

b) Maintenance should only be performed as recommended by the equipment manufacturer. Maintenance and repairs that require the assistance of other qualified personnel must be performed under the supervision of the person competent in the use of flammable refrigerants.

Before starting work on systems containing flammable refrigerants, safety checks are required to ensure that the risk of ignition is minimized.

c) Checks to be carried out on systems that use flammable refrigerants:

- the charge must be proportionate to the size of the room in which the units containing refrigerant are installed;
- units and ventilation openings must function properly and are not obstructed;
- if an indirect refrigerant circuit is used, the secondary circuit must be checked for the presence of refrigerant;
- the marking on the equipment must be visible and indelible. Illegible markings and signs must be corrected;
- refrigerant piping or components must be installed in a location where they are unlikely to be exposed to any substance that can corrode the component-containing refrigerant, unless the components are constructed from materials that are inherently resistant to corrosion or are adequately protected against corrosion.

d) Checks on electrical devices

Repair and maintenance of electrical components must include initial safety checks and component inspection procedures. If there is a fault that could compromise safety, do not connect the power supply to the circuit until it is satisfactorily resolved. If the fault cannot be remedied immediately, but operation must continue, a suitable interim solution must be used. This must be reported to the owner of the equipment so that all parties are informed.

Initial security checks include:

- Check that the capacitors are discharged: this must be done safely to avoid the risk of sparks;
- Verify that no electrical components and wiring are exposed while charging, restoring or draining the system;
- Check that there is ground continuity.

e) Check for refrigerant leaks

The area should be checked with an appropriate refrigerant detector before and during work, to ensure that the technician is aware of potentially toxic or flammable atmospheres. Make sure that the leak detection equipment in use is suitable for use with all applicable refrigerants, i.e. non-sparking, properly sealed or intrinsically safe.

Check for R32 refrigerant leaks

Note: Check for refrigerant leakage in an environment where there are no potential sources of ignition. No halogen probe (or any other detector that uses an open flame) should be used.

Leak Detection Method:

For systems with R32 refrigerant, an electronic leak detection tool is available to detect and leak detection should not be conducted in a refrigerant environment. Make sure the leak detector does not become a potential source of ignition and is applicable to the measured refrigerant. The leak detector must be set for the minimum flammable fuel concentration (percentage) of the refrigerant. Calibrate and adjust to the correct gas concentration (no more than 25%) with the refrigerant used.

The fluid used in leak detection is applicable to most refrigerants. But do not use chloride based solvents to prevent the reaction between chlorine and refrigerants and corrosion of copper piping.

If you suspect a leak, remove all fire from the scene or put out the fire.

If the location of the leak is to be welded, then all refrigerants must be recovered or isolate all refrigerants away from the leak site (using the shut-off valve). Before and during soldering, use OFN to purify the entire system.

f) Presence of fire extinguisher

If hot work is to be performed on the refrigeration equipment or any associated part, adequate fire fighting equipment must be available. It is necessary to have a dry powder or CO₂ extinguisher adjacent to the charging area.

g) Ventilated area

Make sure the area is outdoors or is adequately ventilated before breaking into the system or performing any hot work. Continuous ventilation must be present during the period in which the work is being carried out. Ventilation should safely disperse the released refrigerant and preferably expel it to the atmosphere.

h) Controls on refrigeration equipment

When replacing electrical components, they must be fit for purpose and with the correct specifications. The manufacturer's maintenance and service guidelines should always be followed. If in doubt, consult the manufacturer's technical department for assistance.

i) Repairs on sealed components

During repairs to sealed components, all electrical supplies must be disconnected from the equipment being worked on before removing the sealed covers, etc.

If it is absolutely necessary to have an electrical power supply to the equipment during maintenance, then a leak detection device must be placed at the most critical point to warn of a potentially dangerous situation.

Particular attention must be paid to the following to ensure that, by working on the electrical components, the casing is not altered in such a way as to compromise the level of protection. This includes damage to cables, excessive number of connections, terminals not made to original specifications, damage to gaskets, incorrect assembly of cable glands, etc.

- Make sure the appliance is mounted securely.
- Ensure that gaskets or sealing materials are not degraded to the point that they no longer serve the purpose of preventing the entry of flammable atmospheres. Replacement parts must conform to the manufacturer's specifications.

NOTE: The use of silicone sealant can inhibit the effectiveness of some types of leak detection equipment. Intrinsically safe components do not need to be isolated before working on them.

l) Repair of intrinsically safe components

Do not apply permanent inductive or capacitive loads to the circuit without ensuring that it does not exceed the voltage and current allowed for the equipment in use.

The intrinsically safe components are the only ones that can be worked on in the presence of a flammable atmosphere. The test equipment must be of the correct evaluation.

Replace components only with parts specified by the manufacturer. Other parts can cause the refrigerant to ignite in the atmosphere due to a leak.

j) Wiring

Verify that the wiring is not subject to wear, corrosion, excessive pressure, vibration, sharp edges, or other adverse environmental effects.

The control must also take into account the effects of aging or continuous vibrations from sources such as compressors or fans.

k) Deactivation

Before carrying out this procedure, it is essential that the technician is fully familiar with the equipment and all its details. Good practice is recommended that all refrigerants be recovered safely. Before the task is performed, a sample of the oil and refrigerant must be taken in case an analysis is required before reuse of the recovered refrigerant. It is essential that electricity is available before the start of the activity.

A. Become familiar with the equipment and its operation.

B. Electrically isolate the system.

C. Before attempting the procedure, make sure that:

- mechanical handling equipment is available, if required, for handling the refrigerant cylinders;
- all personal protective equipment is available and used correctly;
- the recovery process is supervised at all times by a competent person;

- Recovery equipment and cylinders comply with appropriate standards.
- D. If possible, drain the refrigerant system.
- E. If vacuum is not possible, make a manifold so that the refrigerant can be removed from the various parts of the system.
- F. Make sure the cylinder is placed on the scale before recovery takes place.
- G. Start the recovery machine and operate according to the manufacturer's instructions
- H. Do not overfill the cylinders. (Not more than 80% by volume of liquid charge).
- I. Do not exceed, even temporarily, the maximum working pressure of the cylinder.
- J. When the cylinders have been filled correctly and the process is complete, ensure that the cylinders and equipment are promptly removed from the site and that all isolation valves on the equipment are closed.
- K. Recovered refrigerant should not be charged to another refrigeration system unless it has been cleaned and checked.

l) Labeling

The equipment must be labeled indicating that it has been shut down and drained of refrigerant. The label must be dated and signed. For appliances containing flammable refrigerants, make sure there are labels on the appliance indicating that the appliance contains flammable refrigerant.

Recovery

When removing refrigerant from a system, whether for maintenance or decommissioning, it is recommended that all refrigerants be removed safely.

When transferring refrigerant to cylinders, ensure that only appropriate refrigerant recovery cylinders are used. Make sure the correct number of cylinders are available to maintain full system charge. All cylinders to be used are designated for the recovered refrigerant and labeled for that refrigerant (i.e. special cylinders for recovering refrigerant). The cylinders must be complete with pressure relief valve and relative shut-off valves in good working order. Empty recovery cylinders are evacuated and, if possible, cooled before recovery takes place.

If compressors or compressor oils need to be removed, make sure they have been evacuated to an acceptable level to ensure that flammable refrigerant does not remain within the lubricant. The evacuation process must be carried out before returning the compressor to suppliers. To speed up this process, only electrical heating of the compressor body must be used. When oil is drained from a system, it must be done safely

Work procedure

The work must be carried out according to a controlled procedure in order to minimize the risk of the presence of flammable gas or vapor during the execution of the work.

2. General work area

All maintenance personnel and others working in the local area should be educated on the nature of the work being performed. Work in confined spaces must be avoided. The area around the work area must be sectioned. Ensure that conditions within the area have been secured by the control of flammable material.

3. No ignition sources

No person carrying out work in relation to a refrigeration system involving exposure to piping must use sources of ignition in a way that creates the risk of fire or explosion. All possible sources of ignition, including cigarette smoke, must be kept sufficiently far from the place of installation, repair, removal and disposal, during which the refrigerant may possibly be released into the surrounding space. Before starting work, the area around the equipment must be checked to ensure that there is no risk of flammability or ignition hazards. "No smoking" signs must be displayed.

Removal and evacuation

When breaking into the refrigerant circuit to make repairs or for any other purpose, conventional procedures must be used. However, for flammable refrigerants it is important to follow the best procedures as there is a risk of flammability.

The following procedure must be followed:

- remove the refrigerant;
- purge the circuit with inert gas; evacuate;
- purge again with inert gas;
- open the circuit by cutting or brazing.

The refrigerant charge must be recovered in the correct recovery cylinders.

For appliances containing flammable refrigerants, the system must be flushed with OFN to make the unit safe. You may need to repeat this process several times. Compressed air or oxygen must not be used for purging refrigerant systems.

For appliances containing flammable refrigerants, flushing must be achieved by breaking the vacuum in the system with OFN and continuing to fill until the operating pressure is reached, then discharging to the atmosphere and finally lowering the vacuum. This process must be repeated until there is no more refrigerant in the system. When the final OFN charge is used, the system must be vented to atmospheric pressure to allow the work to be carried out. This operation is absolutely essential if you want to carry out brazing operations on the pipes.

Make sure that the vacuum pump outlet is not close to ignition sources and that ventilation is available.

Charging procedures

In addition to conventional charging procedures, the following requirements must be followed.

- Make sure that contamination of different refrigerants does not occur when using charging equipment. Hoses or lines should be as short as possible to minimize the amount of refrigerant they contain.
- The cylinders must be kept upright.
- Make sure the refrigeration system is grounded before charging the system with refrigerant.
- Label the system when charging is complete (if not already done).
- Be very careful not to overfill the refrigeration system.

Before recharging the system, it must be pressure tested with the appropriate purge gas.

The system must undergo a leak test upon completion of the charge but prior to commissioning. A subsequent leak test must be carried out before leaving the site.

REGULATION (EU) No. 517/2014 - F-GAS

The unit contains R32, a fluorinated greenhouse gas with global warming potential (GWP) = 675. Do not release R32 into the atmosphere.

X3I ECO PLUS 27 SH - Kg. 0,53 = 0,357 Tonn CO₂ equiv.

X3I ECO PLUS 35 SH - Kg. 0,57 = 0,384 Tonn CO₂ equiv.

X3I ECO PLUS 52 SH - Kg. 0,82 = 0,553 Tonn CO₂ equiv.

X3I ECO PLUS 70 SH - Kg. 1,3 = 0,877 Tonn CO₂ equiv.



improve your life

www.argoclima.com

Argoclima assumes no responsibility for any errors or inaccuracies in the content of this manual and reserves the right to make any changes to this manual at any time and without notice, deemed appropriate for any technical or commercial need.