



improve your life

**X3I ECO PLUS**  
**AIR CONDITIONERS**  
**MONOSPLIT R32 WIFI**

**SERVICE MANUAL**

---



**INDOOR UNIT**

**OURDOOR UNIT**

**X3I ECO PLUS 27 HL WF**

**X3I ECO PLUS 27 SH**

**X3I ECO PLUS 35 HL WF**

**X3I ECO PLUS 35 SH**

**X3I ECO PLUS 52 HL WF**

**X3I ECO PLUS 52 SH**

**X3I ECO PLUS 70 HL WF**

**X3I ECO PLUS 70 SH**

Please read this manual carefully before installing and using the air conditioner, and retain for future reference.

# Table of Contents

<b>Part I : Technical Information</b> .....	<b>1</b>
<b>1. Summary</b> .....	<b>1</b>
<b>2. Specifications</b> .....	<b>2</b>
2.1 Specification Sheet.....	2
2.2 Capacity Variation Ratio According to Temperature .....	7
2.3 Cooling and Heating Data Sheet in Rated Frequency.....	9
<b>3.Outline Dimension Diagram</b> .....	<b>10</b>
3.1 Indoor Unit.....	10
3.2 Outdoor Unit.....	11
<b>4.Refrigerant System Diagram</b> .....	<b>14</b>
<b>5.Electrical Part</b> .....	<b>15</b>
5.1 Wiring Diagram .....	15
5.2 PCB Printed Diagram .....	19
<b>6.Function and Control</b> .....	<b>24</b>
6.1 Remote Controller Introduction .....	24
6.2 Brief Description of Models and Functions.....	29
6.3 Ewpe Smart App Operation Manual.....	38
<b>Part II : Installation and Maintenance</b> .....	<b>39</b>
<b>7.Notes for Installation and Maintenance</b> .....	<b>39</b>
<b>8. Installation</b> .....	<b>44</b>
8.1 Installation Dimension Diagram.....	44
8.2 Installation Parts-checking .....	46
8.3 Selection of Installation Location.....	46
8.4 Electric Connection Requirement .....	46

8.5 Installation of Indoor Unit.....	47
8.6 Installation of Outdoor unit.....	49
8.7 Vacuum Pumping and Leak Detection.....	50
8.8 Check after Installation and Test operation.....	51
<b>9. Maintenance .....</b>	<b>52</b>
9.1 Error Code List.....	52
9.2 Procedure of Troubleshooting .....	57
9.3 Troubleshooting for Normal Malfunction .....	71
<b>10. Removal Procedure .....</b>	<b>73</b>
10.1 Removal Procedure of Indoor Unit.....	73
10.2 Removal Procedure of Outdoor Unit.....	78
<b>Appendix .....</b>	<b>97</b>
Appendix 1: Reference Sheet of Celsius and Fahrenheit.....	97
Appendix 2: Configuration of Connection Pipe .....	97
Appendix 3: Pipe Expanding Method.....	98
Appendix 4: List of Resistance for Temperature Sensor.....	99

# 1. Summary

## Indoor Unit:



## Outdoor Unit:

X3I ECO PLUS 27 SH - X3I ECO PLUS 35 SH

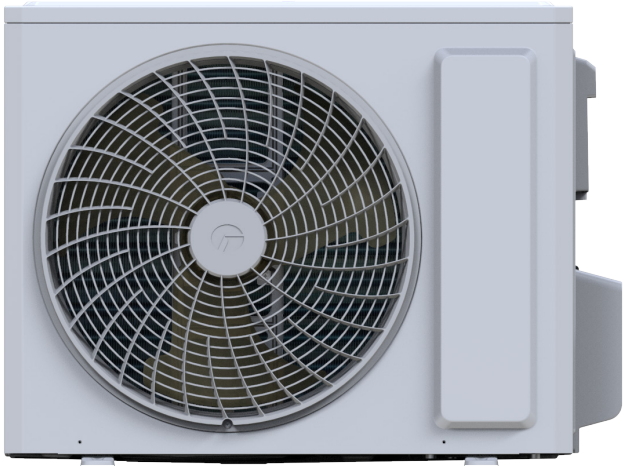

X3I ECO PLUS 52 SH

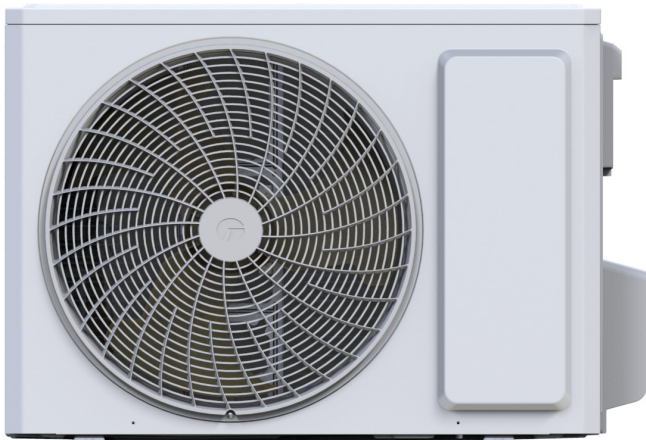

X3I ECO PLUS 70 SH

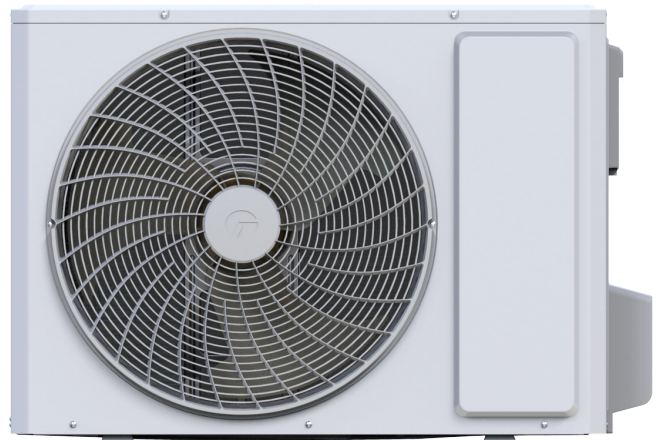

## Remote Controller:



# 2. Specifications

## 2.1 Specification Sheet

Model			X3I ECO PLUS 27 HL WF	
Product Code				
Power Supply	Rated Voltage	V~	220-240	
	Rated Frequency	Hz	50	
	Phases		1	
Power Supply Mode			Outdoor	
Cooling Capacity		W	2700	
Heating Capacity		W	3000	
Cooling Power Input		W	695	
Heating Power Input		W	700	
Cooling Current Input		A	3.1	
Heating Current Input		A	3.2	
Rated Input		W	1400	
Rated Cooling Current		A	6	
Rated Heating Current		A	6.2	
Air Flow Volume		m <sup>3</sup> /h	610/570/540/470/440/420/390	
Dehumidifying Volume		L/h	1.69	
EER		W/W	3.88	
COP		W/W	4.29	
SEER		--	7.5	
SCOP (Warmer/Average/Colder)		--	5.3/4.2/3.4	
Application Area		m <sup>2</sup>	12-18	
Indoor Unit	Model		X3I ECO PLUS 27 HL WF	
	Product Code			
	Fan Type			Cross-flow
	Fan Diameter Length(DXL)		mm	Φ98X633.5
	Cooling Speed		r/min	1200/1100/1050/950/900/850/800
	Heating Speed		r/min	1150/1100/1050/1000/950/900/850
	Fan Motor Power Output		W	20
	Fan Motor RLA		A	0.31
	Fan Motor Capacitor		μF	1.5
	Evaporator Form			Aluminum Fin-copper Tube
	Evaporator Pipe Diameter		mm	Φ5
	Evaporator Row-fin Gap		mm	2-1.4
	Evaporator Coil Length (LXDXW)		mm	635X22.8X306.3
	Swing Motor Model			MP24EB/MP24HF
	Swing Motor Power Output		W	1.5/1.5
	Fuse Current		A	3.15
	Sound Pressure Level		dB (A)	Cooling:38/36/34/31/29/27/25 Heating:38/37/35/34/32/29/28
	Sound Power Level		dB (A)	Cooling:54/48/46/43/41/39/37 Heating:56/49/47/46/44/41/40
	Dimension (WXHXD)		mm	845X289X209
	Dimension of Carton Box (LXWXH)		mm	918X278/364
Dimension of Package (LXWXH)		mm	931X281X379	
Net Weight		kg	10.5	
Gross Weight		kg	12.5	

Outdoor Unit	Outdoor Unit Model		X3I ECO PLUS 27 SH
	Outdoor Unit Product Code		
	Compressor Manufacturer		ZHUHAI LANDA COMPRESSOR CO.,LTD
	Compressor Model		QXF-A082zC170
	Compressor Oil		ZE-G;ES RB68GX or equivalent
	Compressor Type		Rotary
	Compressor LRA.	A	15.00
	Compressor RLA	A	2.56
	Compressor Power Input	W	756.6
	Compressor Overload Protector		/
	Throttling Method		Capillary
	Set Temperature Range	°C	16~30
	Cooling Operation Ambient Temperature Range	°C	-15~50
	Heating Operation Ambient Temperature Range	°C	-15~30
	Condenser Form		Aluminum Fin-copper Tube
	Condenser Pipe Diameter	mm	Φ7
	Condenser Rows-fin Gap	mm	1-1.2
	Condenser Coil Length (LXDXW)	mm	666X19.05X527
	Fan Motor Speed	rpm	900
	Fan Motor Power Output	W	30
	Fan Motor RLA	A	0.40
	Fan Motor Capacitor	μF	/
	Heater Power Input	W	/
	Outdoor Unit Air Flow Volume	m <sup>3</sup> /h	1950
	Fan Type		Axial-flow
	Fan Diameter	mm	Φ400
	Defrosting Method		Automatic Defrosting
	Climate Type		T1
	Isolation		I
	Moisture Protection		IPX4
Permissible Excessive Operating Pressure for the Discharge Side	MPa	4.3	
Permissible Excessive Operating Pressure for the Suction Side	MPa	2.5	
Sound Pressure Level (H/M/L)	dB (A)	50/-/-	
Sound Power Level (H/M/L)	dB (A)	61/-/-	
Dimension(WXHXD)	mm	732X555X330	
Dimension of Carton Box (LXWXH)	mm	791X373X583	
Dimension of Package(LXWXH)	mm	794X376X615	
Net Weight	kg	24.5	
Gross Weight	kg	27	
Refrigerant		R32	
Refrigerant Charge	kg	0.53	
Connection Pipe	Connection Pipe Length	m	5
	Connection Pipe Gas Additional Charge	g/m	16
	Outer Diameter Liquid Pipe	inch	1/4
	Outer Diameter Gas Pipe	inch	3/8
	Max Distance Height	m	10
	Max Distance Length	m	15
Note: The connection pipe applies metric diameter.			

The above data is subject to change without notice. Please refer to the nameplate of the unit.

Outdoor Unit	Outdoor Unit Model		X3I ECO PLUS 35 SH	
	Outdoor Unit Product Code			
	Compressor Manufacturer		ZHUHAI LANDA COMPRESSOR CO.,LTD	
	Compressor Model		FTz-AN108ACBD	
	Compressor Oil		FW68DA or equivalent	
	Compressor Type		Rotary	
	Compressor LRA.	A	/	
	Compressor RLA	A	4.40	
	Compressor Power Input	W	/	
	Compressor Overload Protector		/	
	Throttling Method		Electron expansion valve	
	Set Temperature Range	°C	16~30	
	Cooling Operation Ambient Temperature Range	°C	-15~50	
	Heating Operation Ambient Temperature Range	°C	-15~30	
	Condenser Form		Aluminum Fin-copper Tube	
	Condenser Pipe Diameter	mm	Φ7.94	
	Condenser Rows-fin Gap	mm	1-1.2	
	Condenser Coil Length (LXD <sub>X</sub> W)	mm	666X19.05X527	
	Fan Motor Speed	rpm	900	
	Fan Motor Power Output	W	30	
	Fan Motor RLA	A	0.40	
	Fan Motor Capacitor	μF	/	
	Heater Power Input	W	/	
	Outdoor Unit Air Flow Volume	m <sup>3</sup> /h	1950	
	Fan Type		Axial-flow	
	Fan Diameter	mm	Φ400	
	Defrosting Method		Automatic Defrosting	
	Climate Type		T1	
	Isolation		I	
	Moisture Protection		IPX4	
	Permissible Excessive Operating Pressure for the Discharge Side	MPa	4.3	
	Permissible Excessive Operating Pressure for the Suction Side	MPa	2.5	
Sound Pressure Level (H/M/L)	dB (A)	52/-/-		
Sound Power Level (H/M/L)	dB (A)	63/-/-		
Dimension(WXH <sub>X</sub> D)	mm	732X555X330		
Dimension of Carton Box (LXWXH)	mm	791X373X583		
Dimension of Package(LXWXH)	mm	794X376X598		
Net Weight	kg	24.5		
Gross Weight	kg	27		
Refrigerant		R32		
Refrigerant Charge	kg	0.57		
Connection Pipe	Connection Pipe Length	m	5	
	Connection Pipe Gas Additional Charge	g/m	16	
	Outer Diameter Liquid Pipe	inch	1/4	
	Outer Diameter Gas Pipe	inch	3/8	
	Max Distance Height	m	10	
	Max Distance Length	m	15	
	Note: The connection pipe applies metric diameter.			

The above data is subject to change without notice. Please refer to the nameplate of the unit.

Outdoor Unit	Outdoor Unit Model		X3I ECO PLUS 52 SH
	Outdoor Unit Product Code		
	Compressor Manufacturer		ZHUHAI LANDA COMPRESSOR CO.,LTD
	Compressor Model		QXF-A120zH170A
	Compressor Oil		FW68DA or equivalent
	Compressor Type		Rotary
	Compressor LRA.	A	18.00
	Compressor RLA	A	5.00
	Compressor Power Input	W	1096
	Compressor Overload Protector		HPC115/95U1/KSD115°C
	Throttling Method		Electron expansion valve
	Set Temperature Range	°C	16~30
	Cooling Operation Ambient Temperature Range	°C	-15~50
	Heating Operation Ambient Temperature Range	°C	-15~30
	Condenser Form		Aluminum Fin-copper Tube
	Condenser Pipe Diameter	mm	Φ7
	Condenser Rows-fin Gap	mm	2-1.4
	Condenser Coil Length (LXDXW)	mm	895X38.1X528
	Fan Motor Speed	rpm	880
	Fan Motor Power Output	W	30
	Fan Motor RLA	A	0.40
	Fan Motor Capacitor	μF	/
	Heater Power Input	W	/
	Outdoor Unit Air Flow Volume	m <sup>3</sup> /h	2200
	Fan Type		Axial-flow
	Fan Diameter	mm	Φ420
	Defrosting Method		Automatic Defrosting
	Climate Type		T1
	Isolation		I
	Moisture Protection		IPX4
	Permissible Excessive Operating Pressure for the Discharge Side	MPa	4.3
	Permissible Excessive Operating Pressure for the Suction Side	MPa	2.5
	Sound Pressure Level (H/M/L)	dB (A)	56/-/-
Sound Power Level (H/M/L)	dB (A)	65/-/-	
Dimension(WXHxD)	mm	802X555X350	
Dimension of Carton Box (LXWXH)	mm	869X395X594	
Dimension of Package(LXWXH)	mm	872X398X620	
Net Weight	kg	30.5	
Gross Weight	kg	33	
Refrigerant		R32	
Refrigerant Charge	kg	0.82	
Connection Pipe	Connection Pipe Length	m	5
	Connection Pipe Gas Additional Charge	g/m	16
	Outer Diameter Liquid Pipe	inch	1/4
	Outer Diameter Gas Pipe	inch	1/2
	Max Distance Height	m	10
	Max Distance Length	m	25
Note: The connection pipe applies metric diameter.			

The above data is subject to change without notice. Please refer to the nameplate of the unit.



Outdoor Unit	Outdoor Unit Model		X3I ECO PLUS 70 SH
	Outdoor Unit Product Code		
	Compressor Manufacturer		ZHUHAI LANDA COMPRESSOR CO.,LTD
	Compressor Model		QXFS-M180zX170
	Compressor Oil		FW68DA or equivalent
	Compressor Type		Twin Rotary
	Compressor LRA.	A	35.00
	Compressor RLA	A	3.50
	Compressor Power Input	W	1610
	Compressor Overload Protector		KSD115°C HPC 115/95U1
	Throttling Method		Electron expansion valve
	Set Temperature Range	°C	16~30
	Cooling Operation Ambient Temperature Range	°C	-15~50
	Heating Operation Ambient Temperature Range	°C	-15~30
	Condenser Form		Aluminum Fin-copper Tube
	Condenser Pipe Diameter	mm	Φ7
	Condenser Rows-fin Gap	mm	2-1.4
	Condenser Coil Length (LXDXW)	mm	839X38.1X616
	Fan Motor Speed	rpm	800
	Fan Motor Power Output	W	60
	Fan Motor RLA	A	0.25
	Fan Motor Capacitor	μF	/
	Heater Power Input	W	/
	Outdoor Unit Air Flow Volume	m <sup>3</sup> /h	3600
	Fan Type		Axial-flow
	Fan Diameter	mm	Φ520
	Defrosting Method		Automatic Defrosting
	Climate Type		T1
	Isolation		I
	Moisture Protection		IPX4
	Permissible Excessive Operating Pressure for the Discharge Side	MPa	4.3
	Permissible Excessive Operating Pressure for the Suction Side	MPa	2.5
	Sound Pressure Level (H/M/L)	dB (A)	59/-/-
Sound Power Level (H/M/L)	dB (A)	70/-/-	
Dimension(WXHXD)	mm	958X660X402	
Dimension of Carton Box (LXWXH)	mm	1029X453X715	
Dimension of Package(LXWXH)	mm	1032X456X737	
Net Weight	kg	41.5	
Gross Weight	kg	46	
Refrigerant		R32	
Refrigerant Charge	kg	1.5	
Connection Pipe	Connection Pipe Length	m	5
	Connection Pipe Gas Additional Charge	g/m	40
	Outer Diameter Liquid Pipe	inch	1/4
	Outer Diameter Gas Pipe	inch	5/8
	Max Distance Height	m	10
	Max Distance Length	m	25
Note: The connection pipe applies metric diameter.			

The above data is subject to change without notice. Please refer to the nameplate of the unit.

## 2.2 Capacity Variation Ratio According to Temperature

Heating operation ambient temperature range is -15°C~30°C

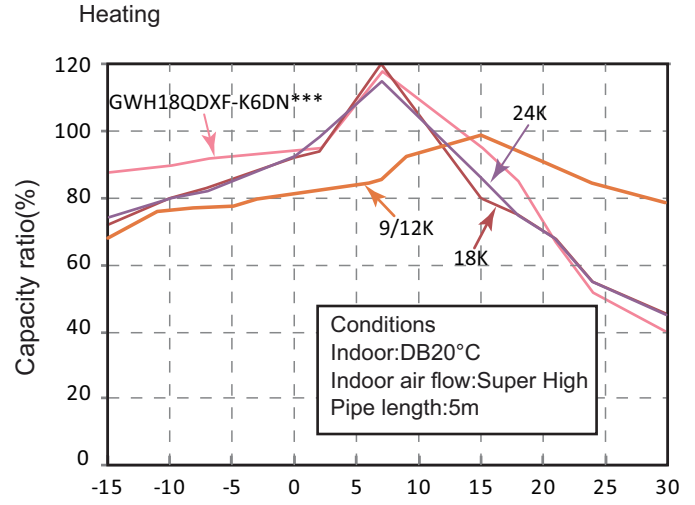
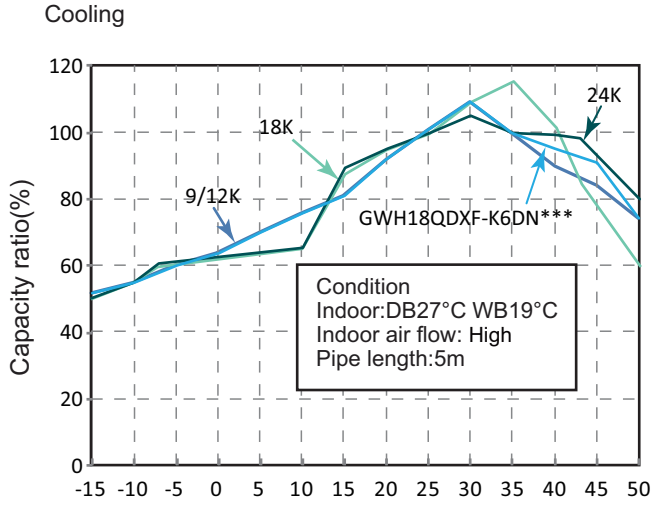

Heating operation ambient temperature range is -25°C~30°C

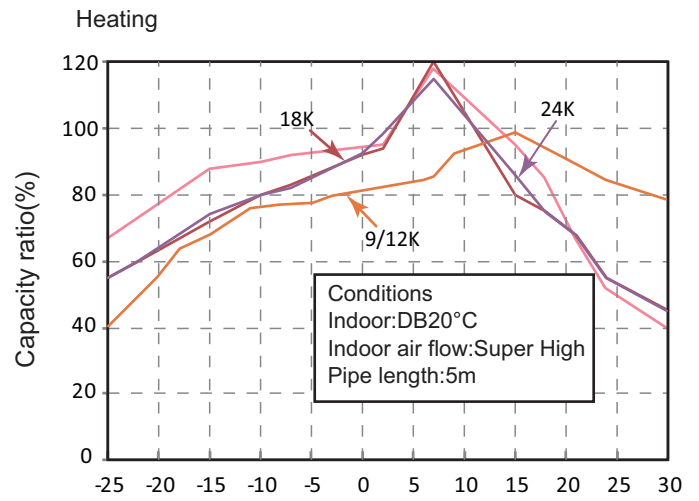
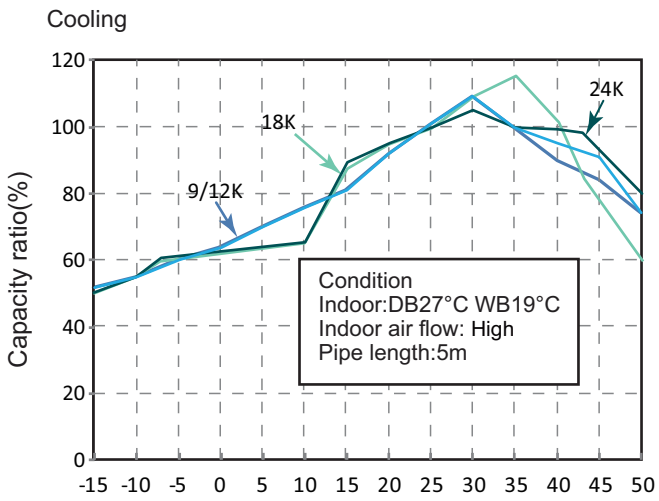

Heating operation ambient temperature range is -15°C~24°C

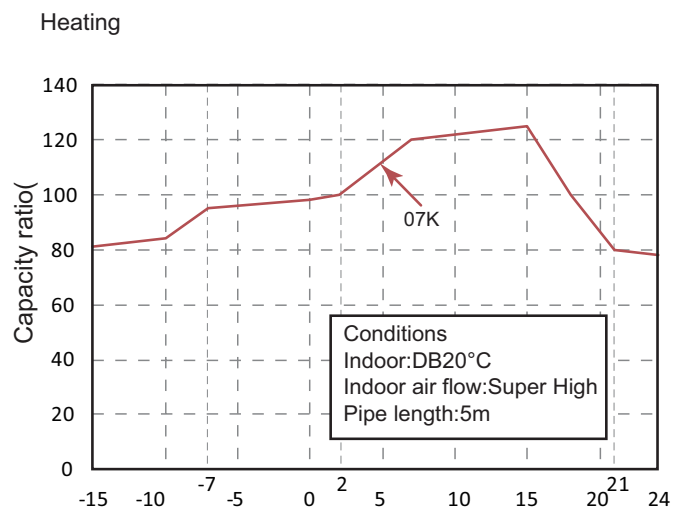
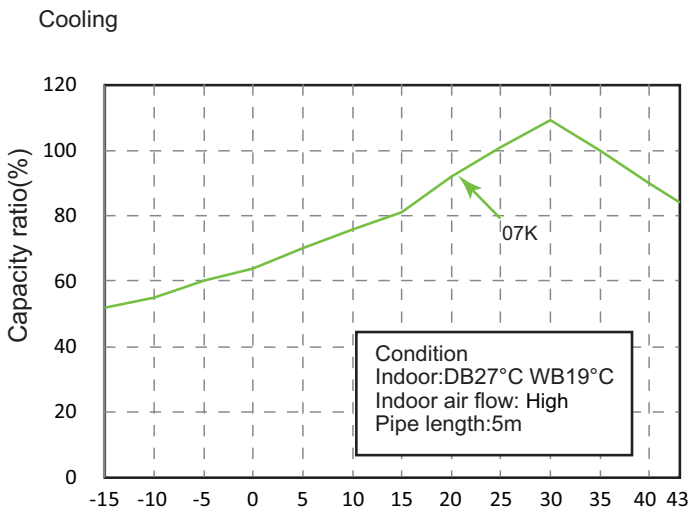
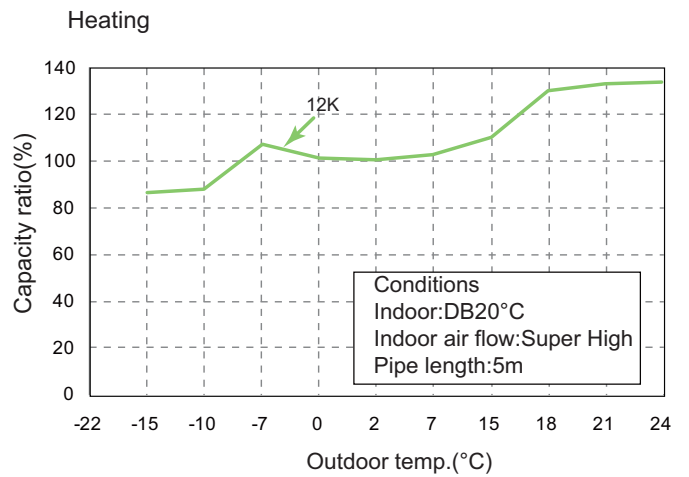
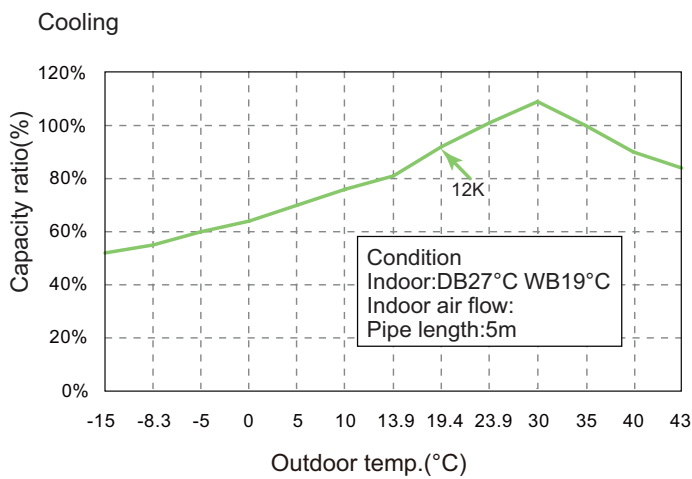
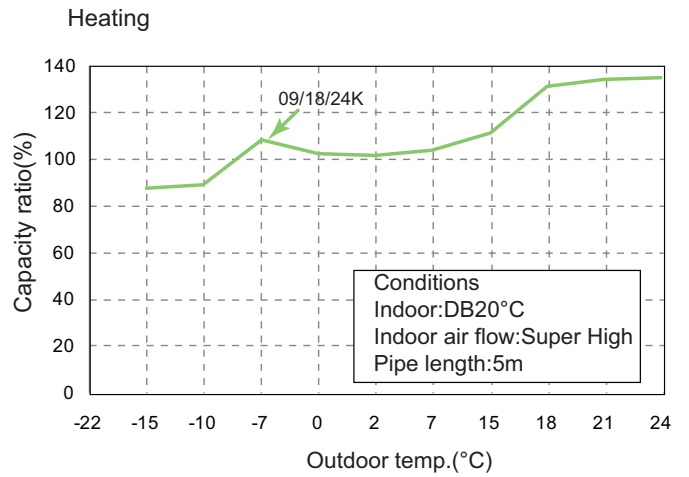
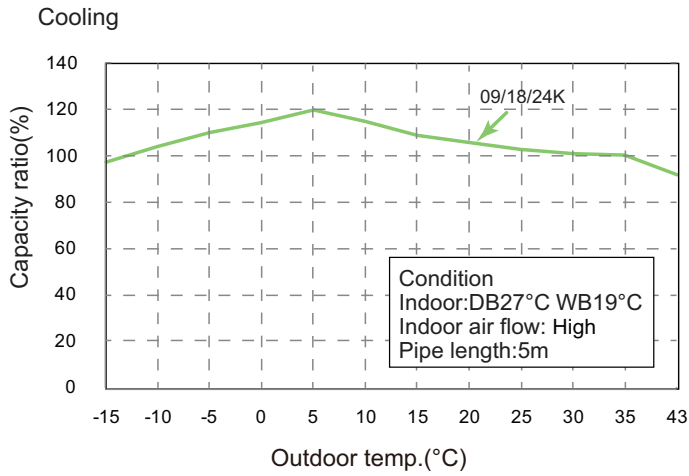

## 2.3 Cooling and Heating Data Sheet in Rated Frequency

Cooling:

Rated cooling condition(°C) (DB/WB)		Model	Pressure of gas pipe connecting indoor and outdoor unit	Inlet and outlet pipe temperature of heat exchanger		Fan speed of indoor unit	Fan speed of outdoor unit
Indoor	Outdoor			P (MPa)	T1 (°C)		
27/19	35/24	09K	0.8 to 1.1	12 to 15	65 to 38	Super High	High
27/19	35/24	12K	0.9 to 1.1	12 to 14	75 to 37	Super High	High
27/19	35/24	18K /24K	0.9 to 1.1	12 to 14	75 to 37	Super High	High

Heating:

Rated cooling condition(°C) (DB/WB)		Model	Pressure of gas pipe connecting indoor and outdoor unit	Inlet and outlet pipe temperature of heat exchanger		Fan speed of indoor unit	Fan speed of outdoor unit
Indoor	Outdoor			P (MPa)	T1 (°C)		
20/-	7/6	09K	2.8 to 3.2	35 to 63	2 to 5	Super High	High
20/-	7/6	12K	2.2 to 2.4	70 to 35	2 to 4	Super High	High

**Instruction:**

T1: Inlet and outlet pipe temperature of evaporator

T2: Inlet and outlet pipe temperature of condenser

P: Pressure at the side of big valve

Connection pipe length: 5 m.

# 3. Outline Dimension Diagram

## 3.1 Indoor Unit

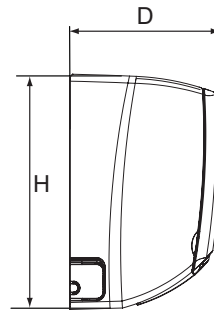
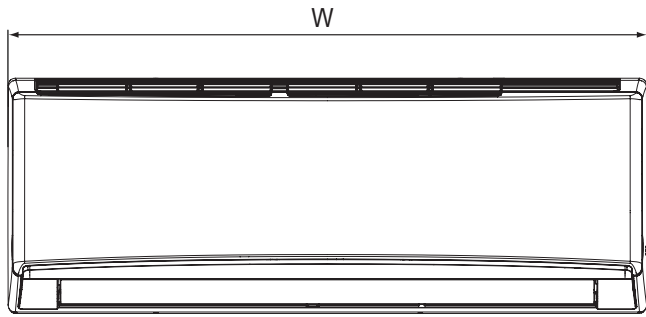

9K - 12K

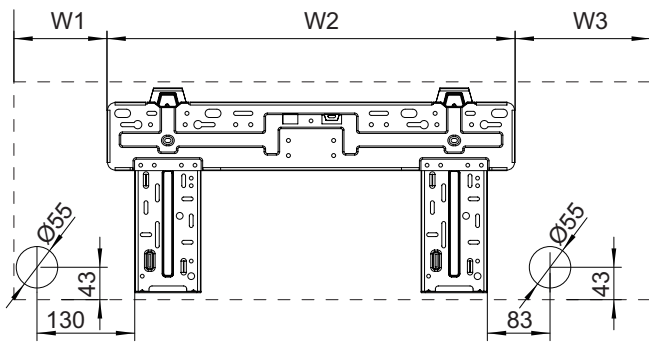

18K

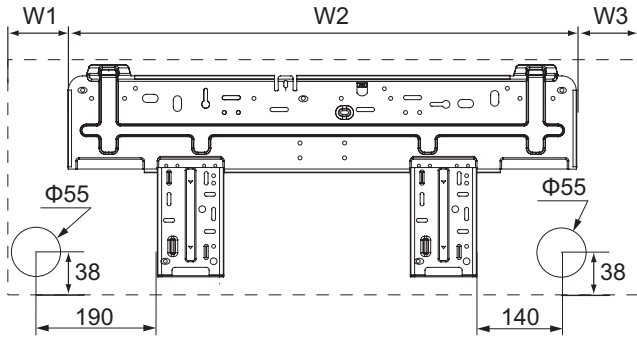

24K

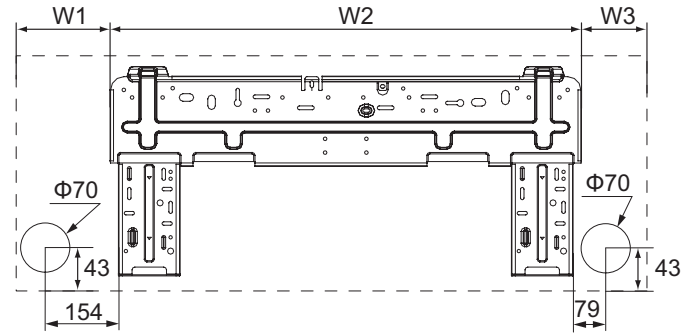

Unit:mm

Model	W	H	D	W1	W2	W3
9K/12K	845	289	209	123	542	180
18K	970	300	224	104	685	181
24K	1078	325	246	206	685	187

## 3.2 Outdoor Unit

X3I ECO PLUS 27 SH - X3I ECO PLUS 35 SH

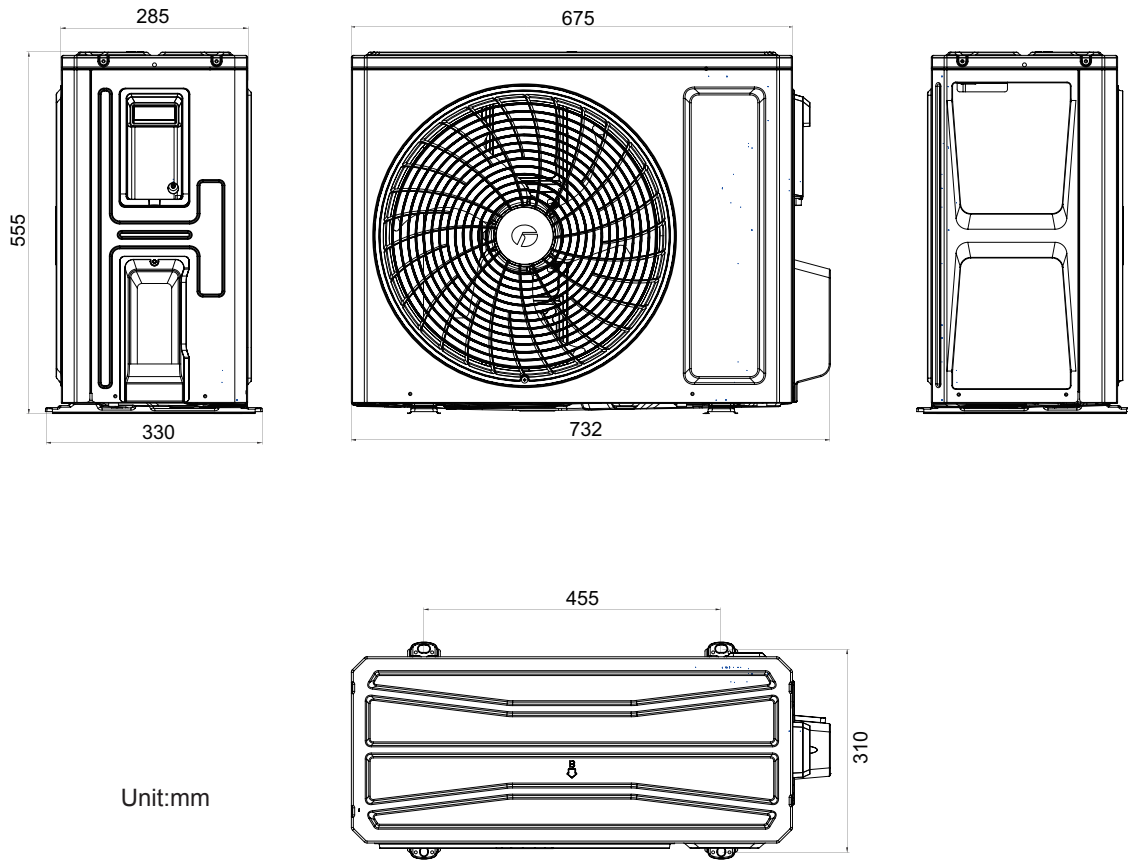

X3I ECO PLUS 52 SH

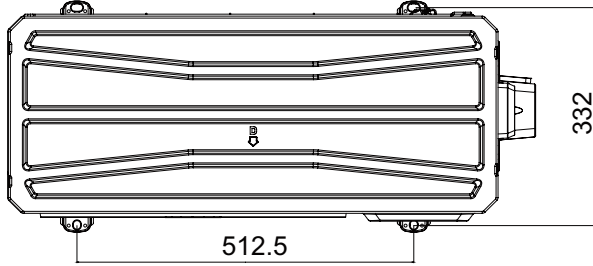
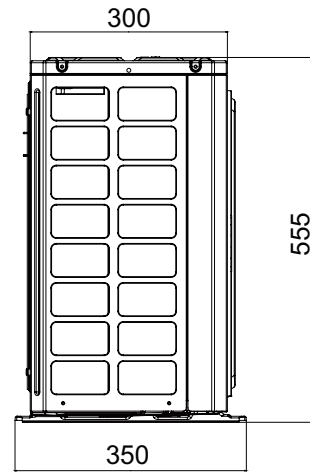
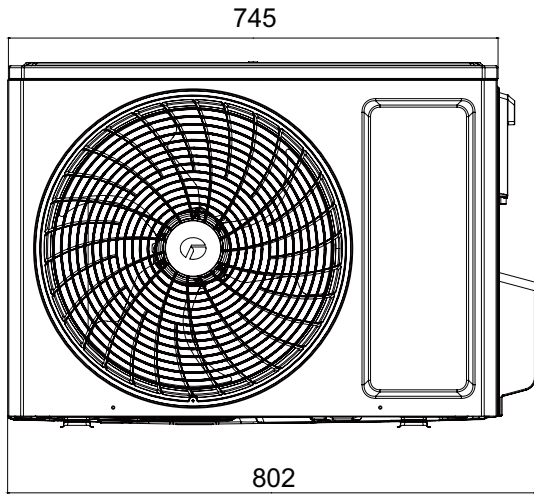

Unit:mm

X3I ECO PLUS 70 SH

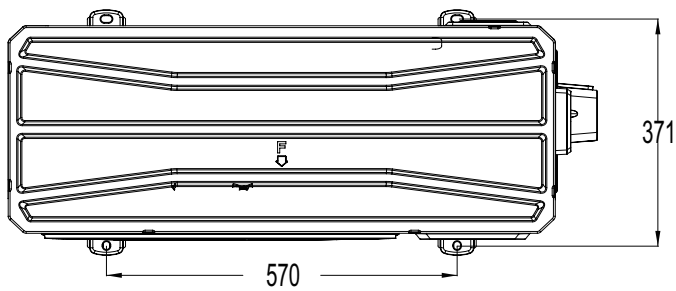
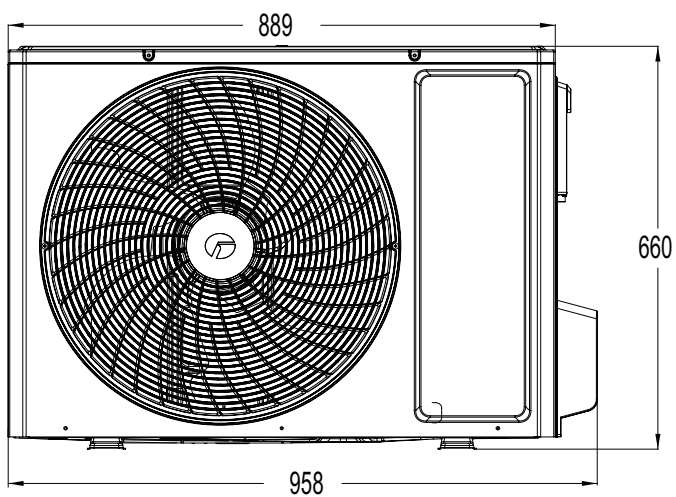
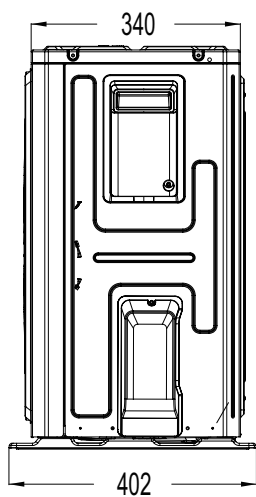

Unit:mm



# 4. Refrigerant System Diagram

X3I ECO PLUS 35 SH X3I ECO PLUS 52 SH X3I ECO PLUS 70 SH

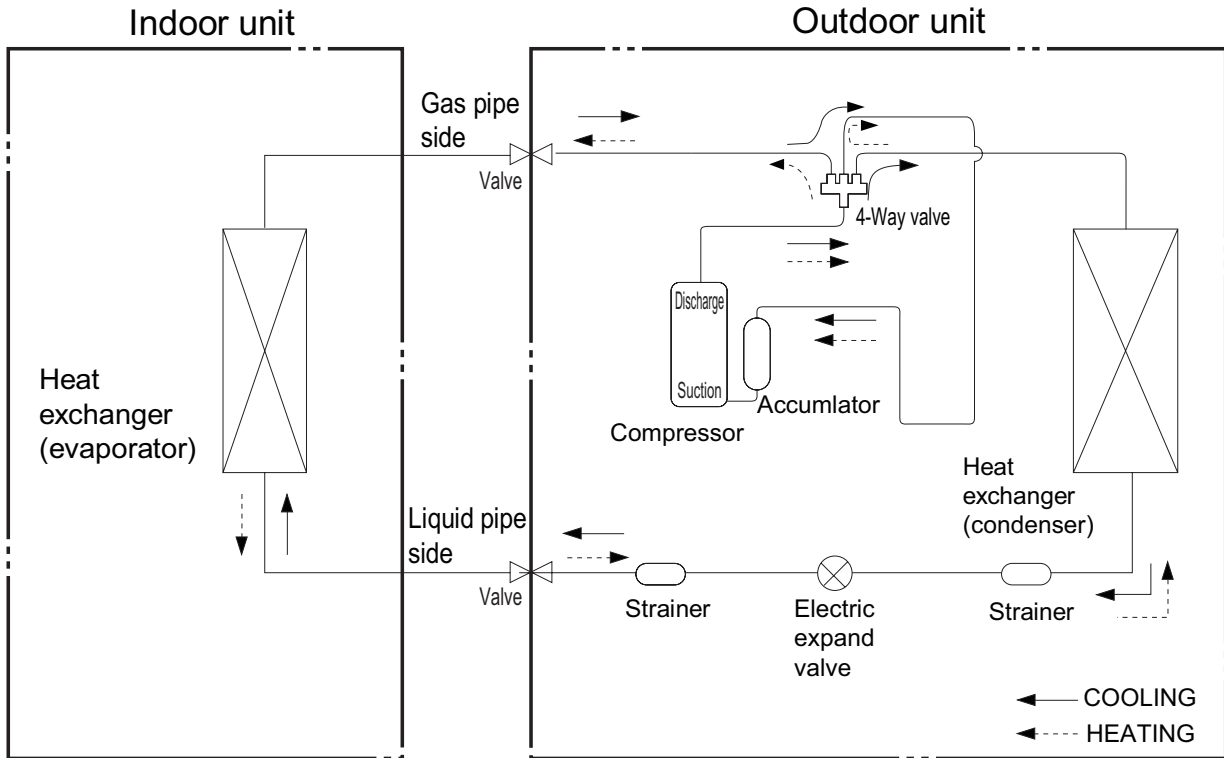

X3I ECO PLUS 27 SH

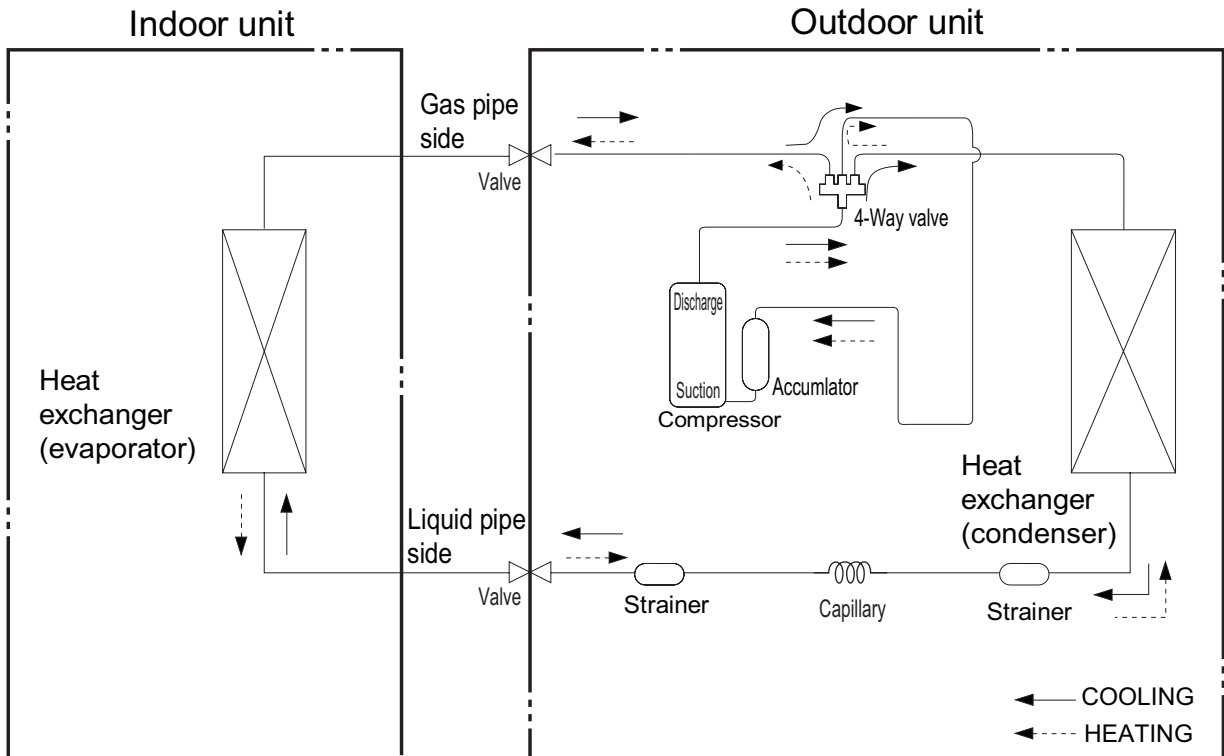

Connection pipe specification:

Liquid pipe: 1/4"

Gas pipe: 3/8" (09/12K)

Gas pipe: 1/2" (18K)

Gas pipe: 5/8" (24K)

# 5. Electrical Part

## 5.1 Wiring Diagram

### •Instruction

Symbol	Symbol Color	Symbol	Symbol Color	Symbol	Name
WH	White	GN	Green	CAP	Jumper cap
YE	Yellow	BN	Brown	COMP	Compressor
RD	Red	BU	Blue		Grounding wire
YEGN	Yellow/Green	BK	Black	/	/
VT	Violet	OG	Orange	/	/

Note: Jumper cap is used to determine fan speed and the swing angle of horizontal lover for this model.

• Indoor Unit

X3I ECO PLUS 27 HL WF

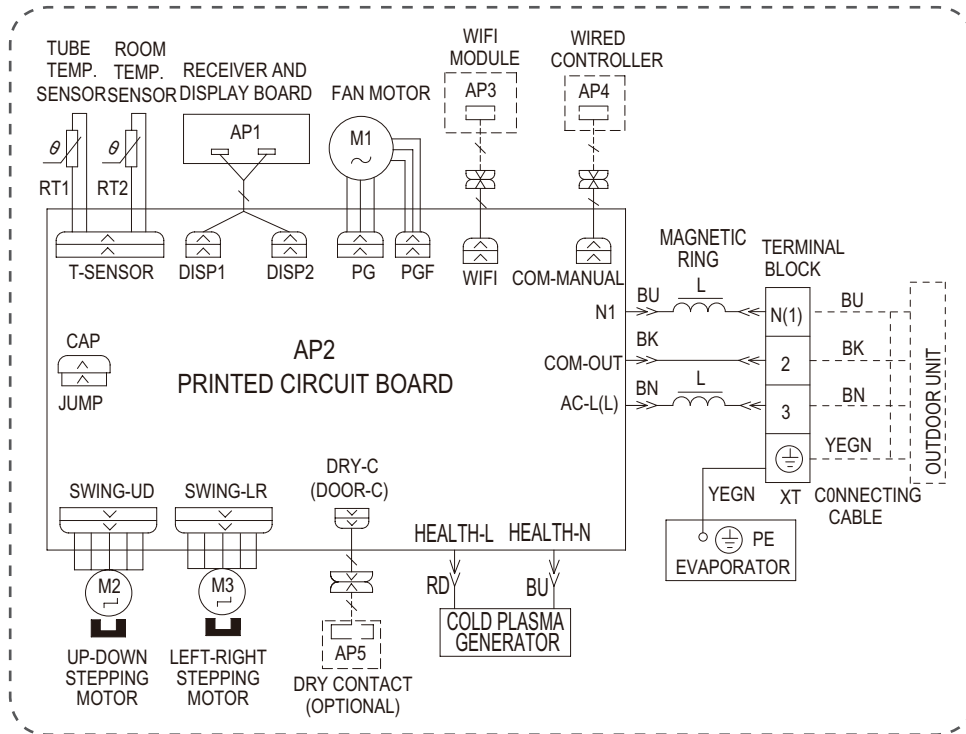

● Outdoor Unit

X3I ECO PLUS 27 SH X3I ECO PLUS 35 SH

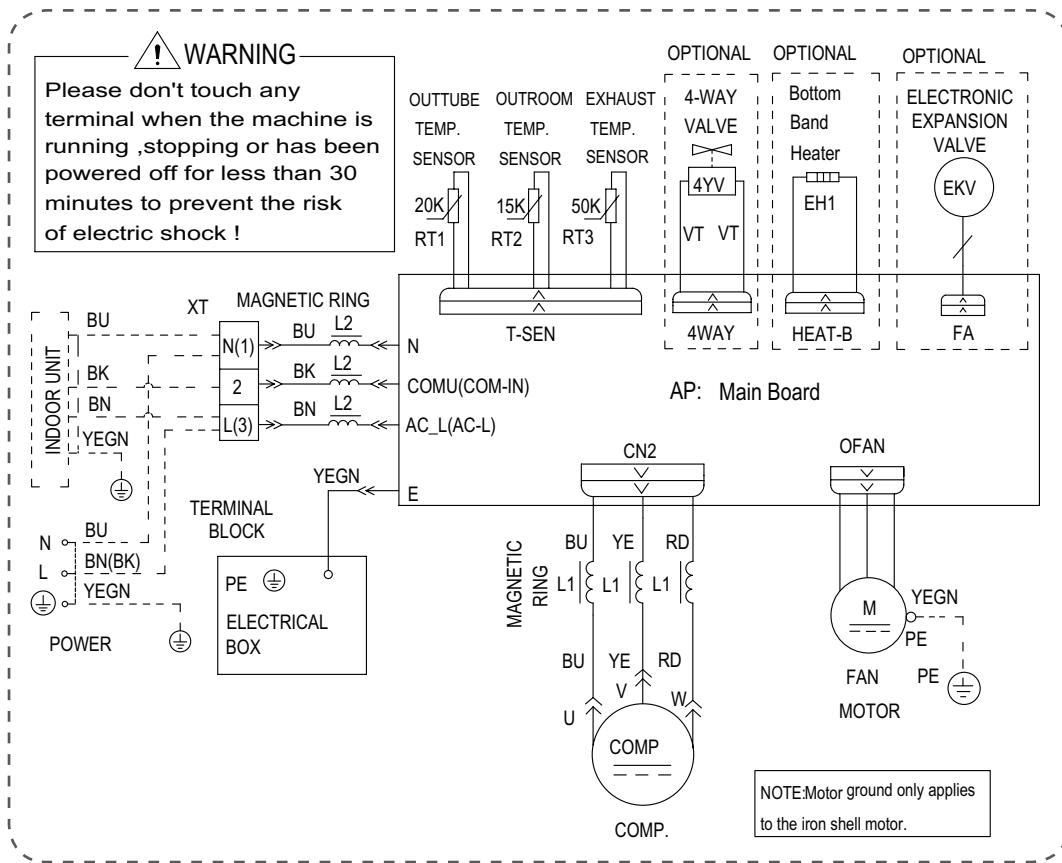

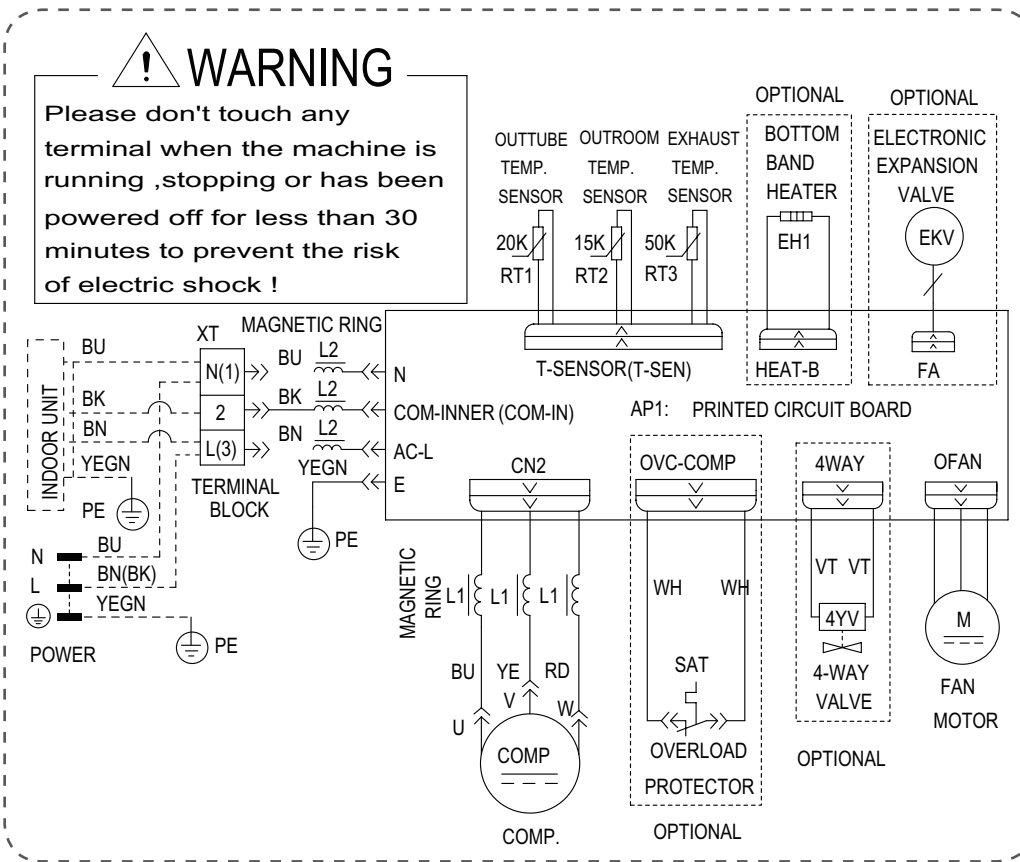

These wiring diagrams are subject to change without notice; please refer to the one supplied with the unit.

## 5.2 PCB Printed Diagram

### Indoor Unit

09/12K/18k

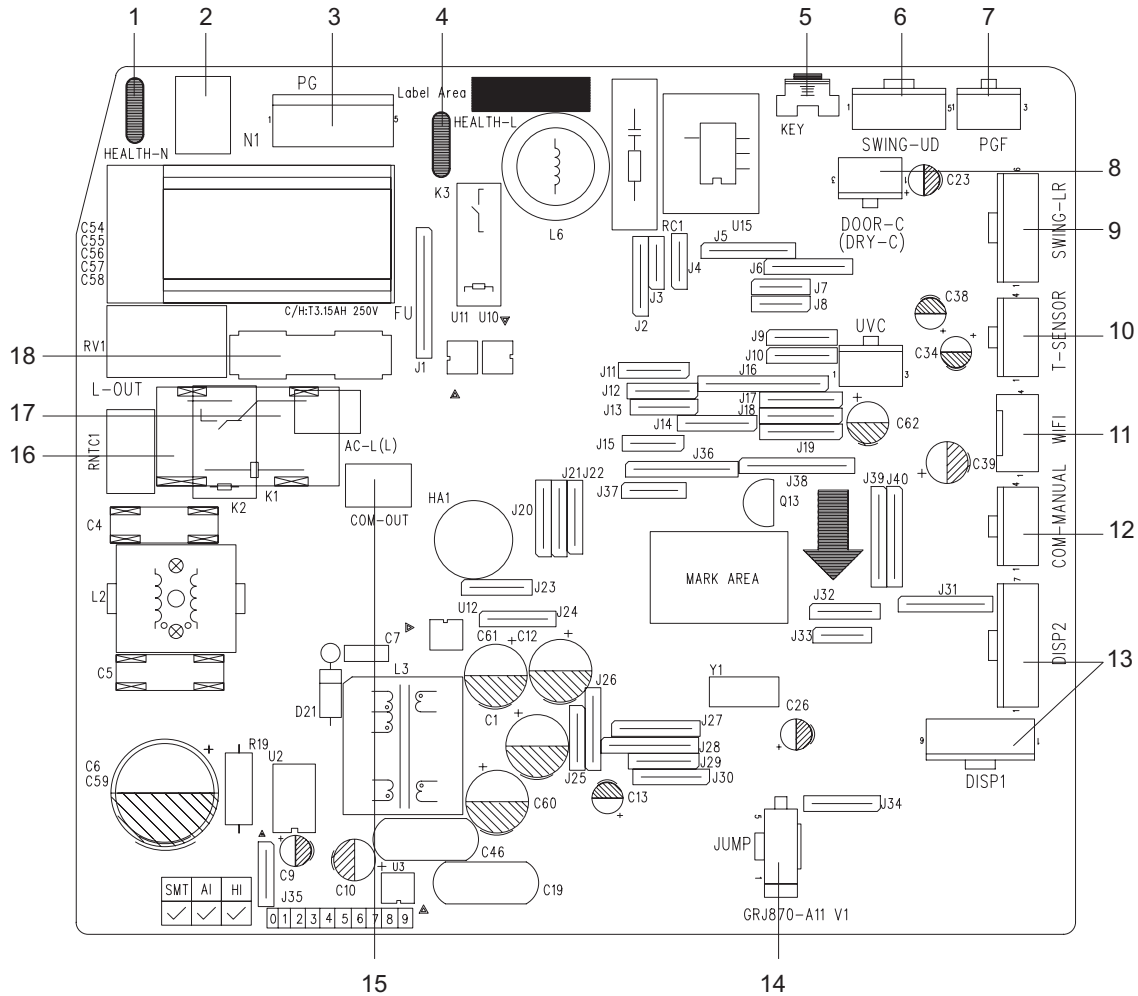

No.	Name	No.	Name
1	Interface of health function neutral wire	10	Terminal of temperature sensor
2	Neutral wire terminal	11	WIFI terminal
3	Motor terminal	12	Wired controller terminal
4	Interface of health function live wire	13	Interface of display board
5	Auto button	14	Jumper cap
6	Up&down swing terminal	15	Communication terminal for indoor unit and outdoor unit
7	Interface of Motor feedback	16	Terminal of live wire used for supplying power for outdoor unit
8	Interface of gate-control	17	Live wire terminal
9	Left&right swing terminal	18	Fuse

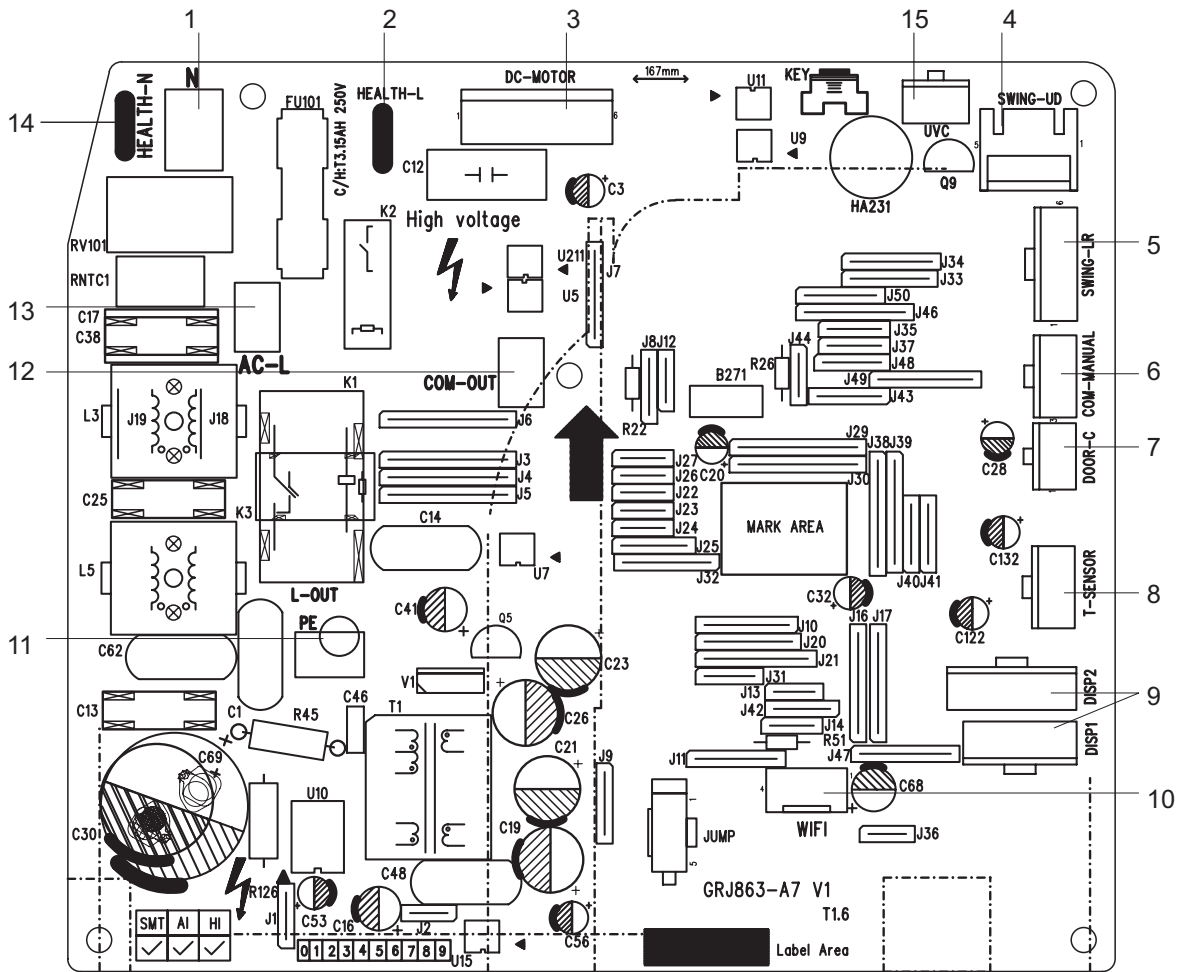

No.	Name	No.	Name
1	Neutral wire	9	Display interface
2	Interface of health function live wire	10	WIFI interface
3	DC fan interface	11	Grounding wire
4	Up&down swing interface	12	Terminal with outdoor unit communication wire
5	Left&right swing interface	13	Live wire interface
6	Interface of wired controller	14	Interface of health function neutral wire
7	Interface of gate control	15	Interface of ultraviolet clean
8	Interface of temperature sensor		

## Outdoor Unit

X3I ECO PLUS 27 SH - X3I ECO PLUS 35 SH

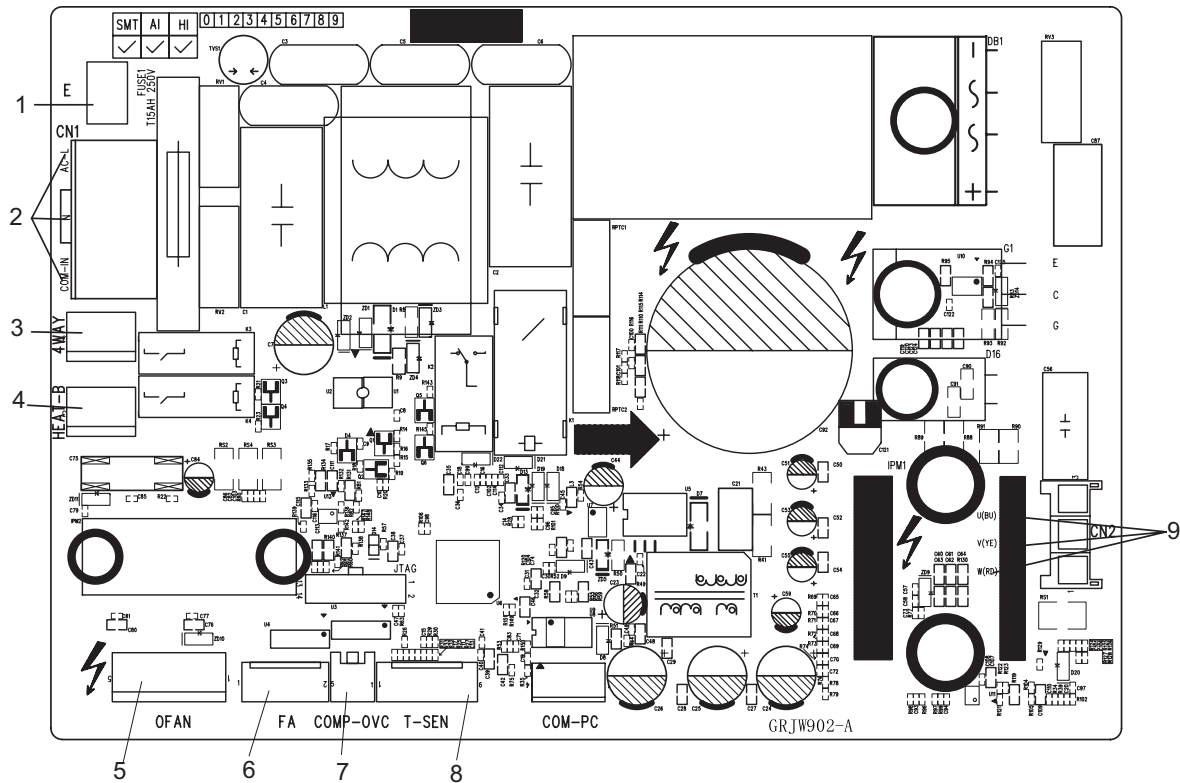

No.	Name
1	Earthing wire
2	Neutral wire, live wire and communication cable
3	4-way valve
4	Electric heating belt of chasssis
5	Outdoor fan
6	Electronic expansion valve
7	Overload
8	Temperature sensor
9	Three-phase terminal of compressor



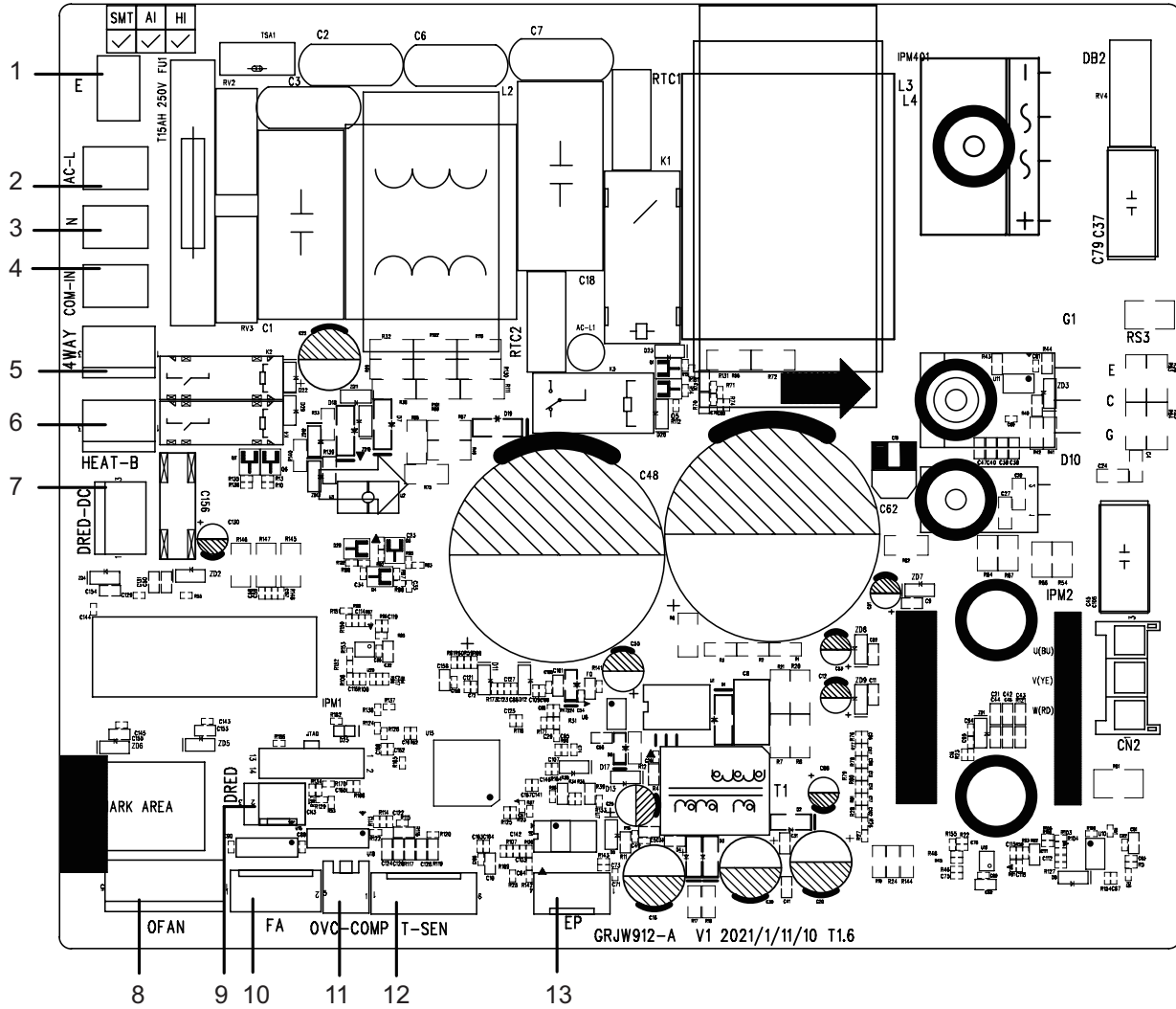

No.	Name	No.	Name
1	Earthing wire	8	Outdoor fan
2	Live wire	9	DRED(Reserved)
3	Neutral wire	10	Electronic expansion valve
4	Communication wire	11	Compressor Overload
5	4-way valve	12	Temperature sensor
6	Electric heating of chassis	13	Compressor
7	DRED-DC(Reserved)		

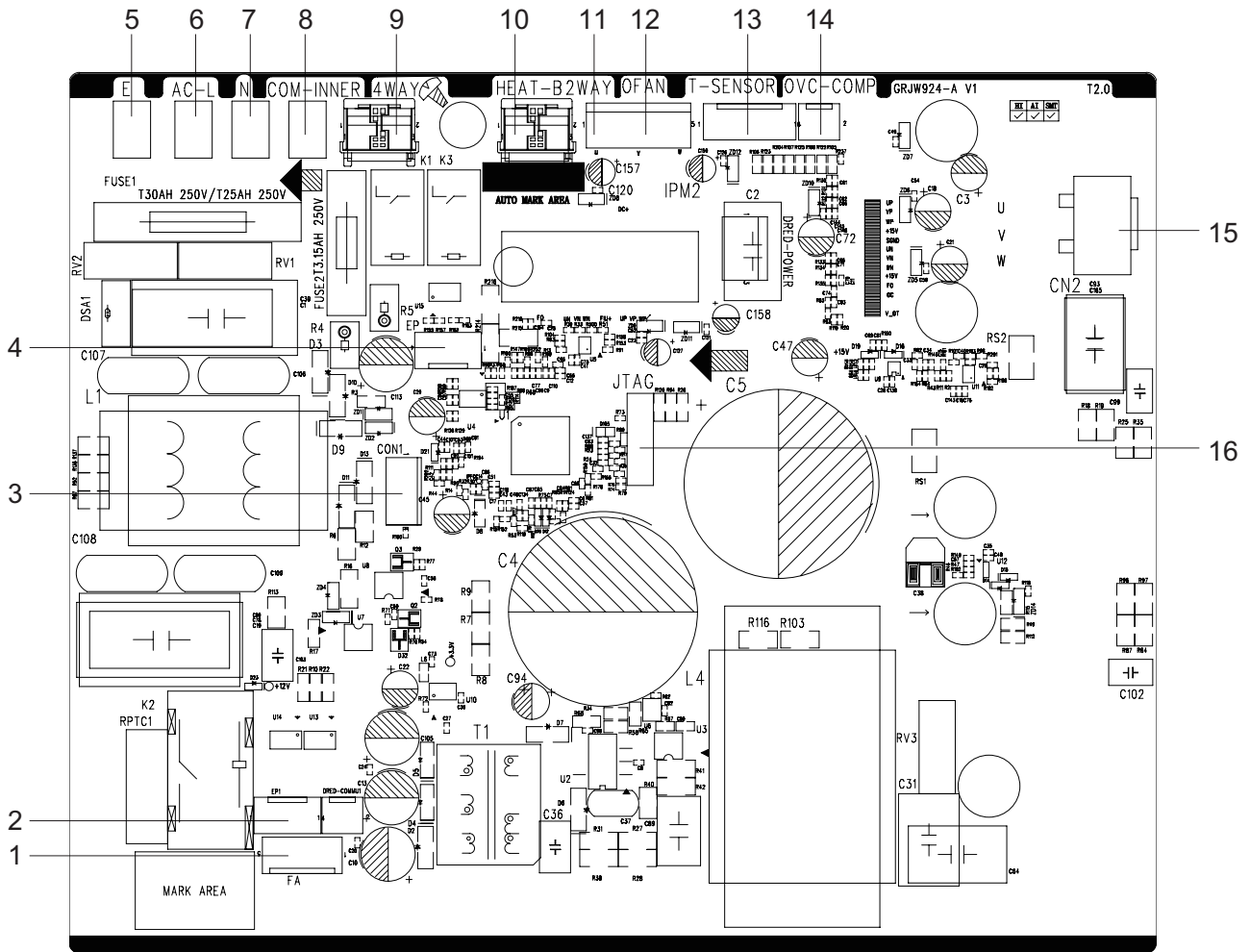

No.	Name	No.	Name
1	Terminal of electronic expansion valve	9	4-way valve
2	E disk(Reserved)	10	Electric heating belt of chassis
3	Computer monitoring interface	11	2-way valve
4	EE flash drive	12	DC motor
5	Grounding wire	13	Temperature sensor
6	Live wire	14	Overload interface of compressor
7	Neutral wire	15	Terminal of compressor
8	Communication wire	16	Interface of program debugs

# 6. Function and Control

## 6.1 Remote Controller Introduction

### Buttons on remote controller



#### NOTE:

- This is a general use remote controller. It could be used for the air conditioner with multifunction. For the functions which the model doesn't have, if press the corresponding button on the remote controller, the unit will keep the original running status.
- After putting through the power, the air conditioner will give out a sound. Power indicator "⏻" is ON. After that, you can operate the air conditioner by using remote controller.
- Under on status, pressing the button on the remote controller, the signal icon "📶" on the display of remote controller will blink once and the air conditioner will give out a "di" sound, which means the signal has been sent to the air conditioner.
- As for the models with functions of WiFi or wired controller, the indoor unit must have been controlled by standard remote controller under auto mode first, and then the function of adjustable temperature under auto mode can be realized by APP or the wired controller.
- This remote controller can adjust the temperature under auto mode. When matching with the unit which is without the function of adjustable temperature under auto mode, the set temperature under auto mode may be invalid, or the displayed set temperature on the unit is not same as that on the remote controller under auto mode.

### Introduction for icons on display screen

	I feel	
	Set fan speed	
	Turbo mode	
	Send signal	
Operation mode		Auto mode
		Cool mode
		Dry mode
		Fan mode
		Heat mode
	Sleep mode	
	8°C heating function	
	Health mode	
	Scavenging function	
	Quiet	
	X-FAN function	
Temp. display type		Set temp.
		Indoor ambient temp.
		Outdoor ambient temp.
	Clock	
	Set temperature	
	WiFi function	
	Set time	
	TIMER ON / TIMER OFF	
	Light	
	Left & right swing	
	Up & down swing	
	Child lock	

#### button

Press this button to turn on the unit. Press this button again to turn off the unit.

#### button

Press this button to select your required operation mode.

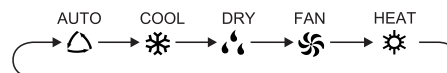

- When selecting auto mode, air conditioner will operate automatically according to the sensed temperature. Press "FAN" button can adjust fan speed. Press "🌀" / "🌀" button can adjust fan blowing angle.
- After selecting cool mode, air conditioner will operate under cool mode. Press "▲" or "▼" button to adjust set temperature. Press "FAN" button to adjust fan speed. Press "🌀" / "🌀" button to adjust fan blowing angle.
- When selecting dry mode, the air conditioner operates at low speed under dry mode. Under dry mode, fan speed can't be adjusted. Press "🌀" / "🌀" button to adjust fan blowing angle.
- When selecting fan mode, the air conditioner will only blow fan, no cooling and no heating. Press "FAN" button to adjust fan speed. Press "🌀" / "🌀" button to adjust fan blowing angle.
- When selecting heat mode, the air conditioner operates under

heat mode. Press "▲" or "▼" button to adjust set temperature. Press "FAN" button to adjust fan speed. Press "↻" / "⌂" button to adjust fan blowing angle.

**NOTE:**

- For preventing cold air, after starting up heat mode, indoor unit will delay 1~5 minutes to blow air (Actual delay time depends on indoor ambient temperature).
- Set temperature range from remote controller: 16~30°C(61~86°F).
- Fan speed: auto, low speed, low-medium speed, medium speed, medium-high speed, high speed.
- Under auto mode, temperature can be displayed; Under auto mode, set temperature can be adjusted.

**FAN button**

This button is used for setting Fan Speed in the sequence that goes from AUTO, , then back to Auto.

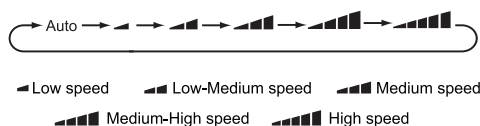

**NOTE:**

- It's low fan speed under dry mode.
- X-FAN function Hold fan speed button for 2s in cool or dry mode, the icon "⊗" is displayed and the indoor fan will continue operation for a few minutes in order to dry the indoor unit even though you have turned off the unit. After energization, X-FAN OFF is defaulted. X-FAN is not available in auto, fan or heat mode. This function indicates that moisture on evaporator of indoor unit will be blown after the unit is stopped to avoid mould.
- Having set X-FAN function on: After turning off the unit by pressing "⏻" button indoor fan will continue running for a few minutes. at low speed. In this period, Hold fan speed button for 2s to stop indoor fan directly.
- Having set X-FAN function off: After turning off the unit by pressing "⏻" button, the complete unit will be off directly.

**TURBO button**

Under cool or heat mode, press this button to turn to quick cool or quick heat mode. "⚡" icon is displayed on remote controller. Press this button again to exit turbo function and "⚡" icon will disappear.

If start this function, the unit will run at super-high fan speed to cool or heat quickly so that the ambient temperature approaches the preset temperature as soon as possible.

**▲ ▼ button**

Press "▲" or "▼" button once increase or decrease set temperature 1°C(°F). Holding "▲" or "▼" button, 2s later, set temperature on remote controller will change quickly. On releasing button after setting is finished, temperature indicator on indoor unit will change accordingly.

When setting TIMER ON, TIMER OFF or CLOCK, press "▲" or

"▼" button to adjust time. (Refer to CLOCK, TIMER ON, TIMER OFF buttons).

**↻ button**

Press this button can select left & right swing angle. Fan blow angle can be selected circularly as below:

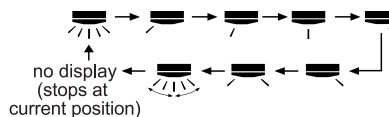

**NOTE:**

- Press this button continuously more than 2s, the main unit will swing back and forth from left to right, and then loosen the button, the unit will stop swinging and present position of guide louver will be kept immediately.
- Under left and right swing mode, when the status is switched from off to , if press this button again 2s later, status will switch to off status directly; if press this button again within 2s, the change of swing status will also depend on the circulation sequence stated above.
- The function is only available for some models.

**↕ button**

Press this button can select up & down swing angle. Fan blow angle can be selected circularly as below:

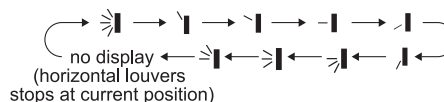



- When selecting "↻", air conditioner is blowing fan automatically. Horizontal louver will automatically swing up & down at maximum angle.
- When selecting "↕", air conditioner is blowing fan at fixed position. Horizontal louver will stop at the fixed position.
- When selecting "↻", air conditioner is blowing fan at fixed angle. Horizontal louver will send air at the fixed angle.
- Hold "↻" button above 2s to set your required swing angle. When reaching your required angle, release the button.

**NOTE:**

- "↻" may not be available. When air conditioner receives this signal, the air conditioner will blow fan automatically.
- Press this button continuously for more than 2s, the main unit will swing back and forth from up to down, and then loosen the button, the unit present position of guide louver will be kept immediately.
- Under up and down swing mode, when the status is switched from off to , if press this button again 2s later, status will switch to off status directly; if press this button again within 2s, the change of swing status will also depend on the circulation sequence stated above.

#### SLEEP button

- Press this button, can select Sleep 1 (  ), Sleep 2 (  ), Sleep 3 (  ) and cancel the Sleep, circulate between these, after electrified, Sleep Cancel is defaulted. Sleep 1 is Sleep mode 1, in Cool modes; sleep status after run for one hour, the main unit setting temperature will increase 1 , two hours, setting temperature increased 2 , then the unit will run at this setting temperature; In Heat mode: sleep status after run for one hour, the setting temperature will decrease 1 , two hours, setting temperature will decrease 2 , then the unit will run at this setting temperature.

- Sleep 2 is sleep mode 2, that is air conditioner will run according to the presetting a group of sleep temperature curve.

- Sleep 3-the sleep curve setting under Sleep mode by DIY;

(1) Under Sleep 3 mode, press "Turbo" button for a long time, remote controller enters into user individuation sleep setting status, at this time, the time of remote controller will display "1hour", the setting temperature "88" will display the corresponding temperature of last setting sleep curve and blink (The first entering will display according to the initial curve setting value of original factory);

(2) Adjust "▲" and "▼" button, could change the corresponding setting temperature, after adjusted, press "Turbo" button for confirmation;

(3) At this time, 1hour will be automatically increased at the timer position on the remote control, (that are "2hours" or "3hours" or "8 hours" ), the place of setting temperature " 88 " will display the corresponding temperature of last setting sleep curve and blink;

(4) Repeat the above step (2)~(3) operation, until 8 hours temperature setting finished, sleep,curve setting finished, at this time, the remote controller will resume the original timer display; temperature display will resume to original setting temperature.

- Sleep 3-the sleep curve setting under Sleep mode by DIY could be inquired: The user could accord to sleep curve setting method to inquire the presetting sleep curve, enter into user individuation sleep setting status, but do not change the temperature, press "Turbo" button directly for confirmation. Note: In the above presetting or enquiry procedure, if continuously within 10s, there is no button pressed, the sleep curve setting within 10s, there is no button pressed , the sleep curve setting status will be automatically quit and resume to display the original displaying. In the presetting or enquiry procedure, press "ON/OFF" button, "Mode" button, " Sleep " button, the sleep curve setting or enquiry status will quit similarly.

#### I FEEL button



Press this button to start I FEEL function and "  " will be displayed on the remote controller. After this function is set, the remote controller will send the detected ambient temperature to the controller and the unit will automatically adjust the indoor temperature according to the detected temperature. Press this

button again to close I FEEL function and " " will disappear.



Please put the remote controller near user when this function is set. Do not put the remote controller near the object of high temperature or low temperature in order to avoid detecting inaccurate ambient temperature. When I FEEL function is turned on, the remote controller should be put within the area where indoor unit can receive the signal sent by the remote controller.

#### TIMER ON / TIMER OFF button

- TIMER ON button

"TIMER ON" button can set the time for timer on. After pressing this button, "  " icon disappears and the word "ON" on remote controller blinks. Press "▲" or "▼" button to adjust TIMER ON setting. After each pressing "▲" or "▼" button. TIMER ON setting will increase or decrease 1min. Holding "▲" or "▼" button, 2s later, the time will change quickly until reaching your required time. Press "TIMER ON" to confirm it. The word "ON" will stop blinking. "  " icon resumes displaying. Cancel TIMER ON: Under the condition that TIMER ON is started up, press "TIMER ON" button to cancel it.



- TIMER OFF button

"TIMER OFF" button can set the time for timer off. After pressing this button, "  " icon disappears and the word "OFF" on remote controller blinks. Press "▲" or "▼" button to adjust TIMER OFF setting. After each pressing "▲" or "▼" button, TIMER OFF setting will increase or decrease 1min. Holding "▲" or "▼" button, 2s later, the time will change quickly until reaching your required time. Press "TIMER OFF" and the word "OFF" will stop blinking. "  " icon resumes displaying. Under the condition that TIMER OFF is started up, press "TIMER OFF" button to cancel it.

#### NOTE:

- Under on and off status, you can set TIMER OFF or TIMER ON simultaneously.
- Before setting TIMER ON or TIMER OFF, please adjust the clock time.
- When turning on TIMER ON or TIMER OFF function, set this function valid all the time and the air conditioner will be turned on or turned off at set temperature every day. "  " button has no affect to setting. If this function is not required, use the remote controller to cancel it.

#### CLOCK button

Press this button to set clock time. "  " icon on remote controller will blink. Press "▲" or "▼" button within 5s to set clock time. Each pressing of "▲" or "▼" button, clock time will increase or decrease 1 minute. If hold "▲" or "▼" button, 2s later, time will change quickly. Release this button when reaching your required time. Press "CLOCK" button to confirm the time. "  " icon stops blinking.

#### NOTE:

- Clock time adopts 24-hour mode.
- The interval between two operations can't exceed 5s. Otherwise, remote controller will quit setting status. Operation for TIMER ON/TIMER OFF is the same.

### QUIET button

Press this button, the Quiet status is under the Auto button Quiet mode (display "🔇" and "AUTO" signal ) and Quiet mode (display "🔇" signal) and Quiet OFF (there is no signal of "🔇" displayed). After powered on, the Quiet OFF is defaulted.

#### NOTE:

- The quiet function is only available for some models.
- The Quiet function can be set up in all modes; Under the Quiet mode, the fan speed is not available.
- When quiet function is selected.

Under cooling mode: indoor fan operates at notch 4 speed. 10 minutes later or when indoor ambient temperature  $\leq 28^{\circ}\text{C}$ , indoor fan will operate at notch 2 speed or quiet mode according to the comparison between indoor ambient temperature and set temperature.

Under heating mode: indoor fan operates at notch 3 speed or quiet mode according to the comparison between indoor ambient temperature and set temperature.

Under dry, fan mode: indoor fan operates at quiet mode.

Under auto mode: the indoor fan operates at the auto quiet mode according to actual cooling, heating or fan mode.

### WiFi button

Press "WiFi" button to turn on WiFi function, "WiFi" icon will be displayed on the remote controller;

Hold "WiFi" button for 5s to turn off WiFi function and "WiFi" icon will disappear.

Under off status, press "MODE" and "WiFi" buttons simultaneously for 1s, WiFi module will restore factory settings.

#### NOTE:

- This function is only available for some models.

### LIGHT button

Press this button to turn off display light on indoor unit. "💡" icon on remote controller disappears.

Press this button again to turn on display light. "💡" icon is displayed.

### 🌿 button

Press this button to turn on or turn off the health and scavenging functions in operation status. Press this button for the first time to start scavenging function; LCD displays "🏠". Press the button for the second time to start health and scavenging functions simultaneously; LCD displays "🏠" and "🌿".

Press this button for the third time to quit health and scavenging functions simultaneously. Press the button for the fourth time to start health function; LCD display "🌿". Press this button again to repeat the operation above.

#### NOTE:

- This function is only available for some models.

### TEMP button

By pressing this button, you can see indoor set temperature, indoor ambient temperature or outdoor ambient temperature on indoor unit's display. The setting on remote controller is selected circularly as below:



- When selecting "🏠" or no display with remote controller, temperature indicator on indoor unit displays set temperature.
- When selecting "🏠🌡️" with remote controller, temperature indicator on indoor unit displays indoor ambient temperature.
- When selecting "🏠🌡️☀️" with remote controller, temperature indicator on indoor unit displays outdoor ambient temperature.

#### NOTE:

- Outdoor temperature display is not available for some models. At that time, indoor unit receives "🏠☀️" signal, while it displays indoor set temperature.
- It's defaulted to display set temperature when turning on the unit. There is no display in the remote controller.
- Only for the models whose indoor unit has dual-8 display.
- When selecting displaying of indoor or outdoor ambient temperature, indoor temperature indicator displays corresponding temperature and automatically turn to display set temperature after three or five seconds.

## Function introduction for combination buttons

### Energy-saving function

Under cooling mode, press "TEMP" and "CLOCK" buttons simultaneously to start up or turn off energy-saving function. When energy-saving function is started up, "SE" will be shown on remote controller, and air conditioner will adjust the set temperature automatically according to e x-factory setting to reach to the best energy-saving effect. Press "TEMP" and "CLOCK" buttons simultaneously again to exit energy-saving function.

#### NOTE:

- Under energy-saving function, fan speed is defaulted at auto speed and it can't be adjusted.
- Under energy-saving function, set temperature can't be adjusted. Press "TURBO" button and the remote controller won't send signal.
- Sleep function and energy-saving function can't operate at the same time. If energy-saving function has been set under cool mode, press sleep button will cancel energy-saving function. If sleep function has been set under cool mode, start up the energy-saving function will cancel sleep function.

### 8°C heating function

Under heat mode, press "TEMP" and "CLOCK" buttons

simultaneously to start up or turn off 8°C heating function. When this function is started up, "⊕" and "8°C" will be shown on remote controller, and the air conditioner keep the heating status at 8°C. Press "TEMP" and "CLOCK" buttons simultaneously again to exit 8°C heating function.

**NOTE:**

- Under 8°C heating function, fan speed is defaulted at auto speed and it can't be adjusted.
- Under 8°C heating function, set temperature can't be adjusted. Press "TURBO" button and the remote controller won't send signal.
- Sleep function and 8°C heating function can't operate at the same time. If 8°C heating function has been set under heat mode, press sleep button will cancel 8 °C heating function. If sleep function has been set under heat mode, start up the 8°C heating function will cancel sleep function.
- Under °F temperature display, the remote controller will display 46°F heating.

**Child lock function**

Press "▲" and "▼" simultaneously to turn on or turn off child lock function. When child lock function is on, "🔒" icon is displayed on remote controller. If you operate the remote controller, the "🔒" icon will blink three times without sending signal to the unit.

**Temperature display switchover function**

Under OFF status, press "▼" and "MODE" buttons simultaneously to switch temperature display between °C and °F.

**Auto clean function**

Under unit off status, hold "MODE" and "FAN" buttons simultaneously for 5s to turn on or turn off the internal clean function. When the internal clean function is turned on, indoor unit displays "CL" .

During the self-cleaning process of evaporator, the unit will perform fast cooling or fast heating. There may be some noise, which is the sound of flowing liquid or thermal expansion or cold shrinkage. The air conditioner may blow cool or warm air, which is a normal phenomenon. During cleaning, please make sure the room is well ventilated to avoid affecting the degree of comfort.

**Replacement of batteries in remote controller**

- 1.Press the back side of remote controller marked with "OPEN", as shown in the fig, and then push out the cover of battery box along the arrow direction.
- 2.Replace two 7# (AAA 1.5V) dry batteries, and make sure the position of "+" polar and "-" polar are correct.
- 3.Reinstall the cover of battery box.

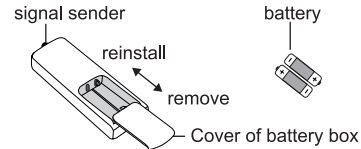

**NOTE:**

- During operation, point the remote control signal sender at the receiving window on indoor unit.
- The distance between signal sender and receiving window should be no more than 8m, and there should be no obstacles between them.
- Signal may be interfered easily in the room where there is fluorescent lamp or wireless telephone; remote controller should be close to indoor unit during operation.
- Replace new batteries of the same model when replacement is required.
- When you don't use remote controller for a long time, please take out the batteries.
- If the display on remote controller is fuzzy or there's no display, please replace batteries.

## 6.2 Brief Description of Models and Functions

### ● Indoor Unit

#### 1. Basic function of system

##### (1) Cooling mode

- (1) Under this mode, fan and swing operates at setting status. Temperature setting range is 16~30°C.
- (2) During malfunction of outdoor unit or the unit is stopped because of protection, indoor unit keeps original operation status.

##### (2)Drying mode

- (1) Under this mode, fan operates at low speed and swing operates at setting status. Temperature setting range is 16~30°C.
- (2) During malfunction of outdoor unit or the unit is stopped because of protection, indoor unit keeps original operation status.
- (3) Protection status is same as that under cooling mode.
- (4) Sleep function is not available for drying mode.

##### (3)Heating mode

- (1) Under this mode, Temperature setting range is 16~30°C.
- (2) Working condition and process for heating mode:  
When turn on the unit under heating mode, indoor unit enters into cold air prevention status. When the unit is stopped or at OFF status, and indoor unit has been started up just now, the unit enters into residual heat-blowing status.

##### (4)Working method for AUTO mode:

1. Working condition and process for AUTO mode:
  - a. Under AUTO mode, standard heating  $T_{\text{preset}}=20^{\circ}\text{C}$  and standard cooling  $T_{\text{preset}}=25^{\circ}\text{C}$ . The unit will switch mode automatically according to ambient temperature.
2. Protection function
  - a. During cooling operation, protection function is same as that under cooling mode.
  - b. During heating operation, protection function is same as that under heating mode.
3. Display: Set temperature is the set value under each condition. Ambient temperature is ( $T_{\text{amb.}}-T_{\text{compensation}}$ ) for heat pump unit and  $T_{\text{amb.}}$  for cooling only unit.
4. If theres I feel function,  $T_{\text{compensation}}$  is 0. Others are same as above.

##### (5)Fan mode

Under this mode, indoor fan operates at set fan speed. Compressor, outdoor fan, 4-way valve and electric heating tube stop operation. Indoor fan can select to operate at high, medium, low or auto fan speed. Temperature setting range is 16~30°C.

#### 2. Other control

##### (1) Buzzer

Upon energization or availably operating the unit or remote controller, the buzzer will give out a beep.

##### (2) Auto button

If press this auto button when turning off the unit, the complete unit will operate at auto mode. Indoor fan operates at auto fan

speed and swing function is turned on. Press this auto button at ON status to turn off the unit.

##### (3) Auto fan

Heating mode: During auto heating mode or normal heating ode, auto fan speed will adjust the fan speed automatically according to ambient temperature and set temperature.

##### (4) Sleep

After setting sleep function for a period of time, system will adjust set temperature automatically.

##### (5) Timer function:

General timer and clock timer functions are compatible by equipping remote controller with different functions.

##### (6) Memory function

memorize compensation temperature, off-peak energization value. Memory content: mode, up&down swing, light, set temperature, set fan speed, general timer (clock timer cant be memorized). After power recovery, the unit will be turned on automatically according to memory content.

##### (7) Health function

During operation of indoor fan, set health function by remote controller. Turn off the unit will also turn off health function. Turn on the unit by pressing auto button, and the health is defaulted ON.

Once compressor is started, it wont stop within 6 mins according to the change of room temp.

##### (8)I feel control mode

After controller received I feel control signal and ambient temperature sent by remote controller, controller will work according to the ambient temperature sent by remote controller.

##### (9)Entry condition for compulsory defrosting function

When turn on the unit under heating ode and set temperature is 16°C (or 16.5°C by remote controller), press “▲, ▼, ▲, ▼▲, ▼(+, -, +, -, +, -)” button successively within 5s and then indoor unit will enter into compulsory defrosting setting status:

- (1) If theres only indoor units controller, it enters into indoor normal defrosting mode.
- (2) If theres indoor units controller and outdoor units controller, indoor unit will send compulsory defrosting mode signal to outdoor unit and then outdoor unit will operate under normal defrosting mode. After indoor unit received the signal that outdoor unit has entered into defrosting status, indoor unit will cancel to send compulsory mode to outdoor unit. If outdoor unit hasnt received feedback signal from outdoor unit after 3min, indoor unit will also cancel to send compulsory defrosting signal.

##### (10)Refrigerant recovery function:

Enter into Freon recovery mode actively: Within 5min after energization, turn on the unit at 16°C under cooling mode, and press light button for 3 times within 3s to enter into Freon recovery mode. Fo is displayed and Freon recovery mode will be sent to outdoor unit.



### **(11) Ambient temperature display control mode**

1. When user set the remote controller to display set temperature (corresponding remote control code: 01), current set temperature will be displayed.

2. Only when remote control signal is switched to indoor ambient temperature display status (corresponding remote control code: 10) from other display status (corresponding remote control code: 00, 01, 11), controller will display indoor ambient temperature for 3s and then turn back to display set temperature.

Under this mode, indoor fan operates at set fan speed. Compressor, outdoor fan, 4-way valve and electric heating tube stop operation. Indoor fan can select to operate at high, medium, low or auto fan speed. Temperature setting range is 16~30°C.

### **(12) Off-peak energization function:**

Adjust compressors minimum stop time. The original minimum stop time is 180s and then we change to:

The time interval between two start-ups of compressor can't be less than  $180+T_s$  ( $0 \leq T \leq 15$ ). T is the variable of controller. That's to say the minimum stop time of compressor is 180s~195s. Read-in T into memory chip when refurbish the memory chip each time. After power recovery, compressor can only be started up after  $180+T$  s at least.

### **(13) SE control mode**

The unit operates at SE status.

### **(14) X-fan mode**

When X-fan function is turned on, after turn off the unit, indoor fan will still operate at low speed for 2min and then the complete unit will be turned off. When x-fan function is turned off, after turn off the unit, the complete unit will be turned off directly.

### **(15) 8°C heating function**

Under heating mode, you can set 8°C heating function by remote controller. The system will operate at 8°C set temperature.

### **(16) Turbo function**

Turbo function can be set under cooling and heating modes. Press Fan Speed button to cancel turbo setting. Turbo function is not available under auto, drying and fan modes.

## ● Outdoor Unit (09/12K)

### 1. Cooling mode:

Working condition and process of cooling mode:

① When Tindoor ambient temperature  $\geq T_{\text{preset}}$ , unit enters into cooling mode. Indoor fan, outdoor fan and compressor start operation. Indoor fan operates according to set fan speed.

② When Tindoor ambient temperature  $\leq T_{\text{preset}} - 2^{\circ}\text{C}$ , compressor stops operation and outdoor fan will stop 30s later. Indoor fan operates according to set fan speed.

③ When  $T_{\text{preset}} - 2^{\circ}\text{C} < \text{Tindoor ambient temperature} < T_{\text{preset}}$ , unit operates according to the previous status.

Under cooling mode, 4-way valve is not energized. Temperature setting range is  $16 \sim 30^{\circ}\text{C}$ . If compressor stops because of malfunction in cooling mode, indoor fan and swing motor will work according to the original status.

### 2. Drying mode

(1) Working condition and process of drying mode

① When Tindoor ambient temperature  $> T_{\text{preset}}$ , unit will be in drying mode. Outdoor fan and compressor start operation while indoor fan will operate at low fan speed.

② When  $T_{\text{preset}} - 2^{\circ}\text{C} \leq \text{Tindoor ambient temperature} \leq T_{\text{preset}}$ , unit operates according to the previous status.

③ When Tindoor ambient temperature  $< T_{\text{preset}} - 2^{\circ}\text{C}$ , compressor stops operation and outdoor fan will stop 30s later.

(2) Under drying mode, 4-way valve is not energized. Temperature setting range is  $16 \sim 30^{\circ}\text{C}$ .

(3) Protection function: same as in cooling mode.

### 3. Fan mode

(1) Under this mode, indoor fan can select different fan speed (except Turbo) or auto fan speed. Compressor, outdoor fan and 4-way valve all stop operation.

(2) In fan mode, temperature setting range is  $16 \sim 30^{\circ}\text{C}$ .

### 4. Heating mode

Working condition and process of heating mode:

① When  $T_{\text{preset}} - (\text{Tindoor ambient temperature} - T_{\text{compensation}}) \geq 1^{\circ}\text{C}$ , unit enters into heating mode. Compressor, outdoor fan and 4-way valve start operation.

② When  $-2^{\circ}\text{C} < T_{\text{preset}} - (\text{Tindoor ambient temperature} - T_{\text{compensation}}) < 1^{\circ}\text{C}$ , unit operates according to the previous status.

③ When  $T_{\text{preset}} - (\text{Tindoor ambient temperature} - T_{\text{compensation}}) \leq -2^{\circ}\text{C}$ , compressor stops operation and outdoor fan will stop 30s later. Indoor fan will be in residual-heat blowing status.

④ When unit is turned off under heating mode or changed to other modes from heating mode, 4-way valve will be power-off 2min after compressor stops working (compressor is in operation status under heating mode).

⑤ When Tindoor ambient temperature  $> 30^{\circ}\text{C}$ , compressor stops operation immediately. Outdoor fan will stop 30s later.

⑥ Under the condition that compressor is turned on, when unit is changed to heating mode from cooling or drying mode, 4-way valve will be energized in 2~3mins delay.

Note: Tcompensation is determined by IDU and ODU. If IDU controls the compensation temperature, then Tcompensation is determined according to the value sent by IDU to ODU; If IDU does not control the compensation temperature, then Tcompensation will default to  $3^{\circ}\text{C}$  by the ODU.

### 5. Freon recovery mode

After the Freon recovery signal from IDU is received, cooling at rated frequency will be forcibly turned on to recover Freon.

Indoor unit will display Fo. If any signal from remote controller is received, unit will exit from Freon recovery mode and indoor unit stops displaying Fo.

### 6. Compulsory defrosting

If unit is turned on under heating mode and set temperature is  $16^{\circ}\text{C}$  (by remote controller), press “▲, ▼, ▲, ▼, ▲, ▼ (+, -, +, -, +, -)” within 5s, unit will enter into compulsory defrosting mode and send the signal to ODU. When the compulsory defrosting signal from ODU is received, IDU will exit from the compulsory defrosting mode and stop sending the signal to ODU.

After ODU receives the compulsory defrosting code, it will start compulsory defrosting. Defrosting frequency and opening angle will be the same as in normal defrosting mode. When compulsory defrosting is finished, the complete unit resumes original status.

### 7. Auto mode

Auto mode is determined by controller of IDU. See IDU logic for details.

### 8. 8°C heating

Set temperature is  $8^{\circ}\text{C}$ . Display board of IDU displays  $8^{\circ}\text{C}$ . Under this mode, “Cold air prevention” function is shielded.

If compressor is operating under this mode, fan speed will adjust according to auto fan speed; if compressor stops operation under this mode, indoor fan will be in residual-heat blowing status.

**When power on, communication light will be blinking in a normal way (after receiving a group of correct signals, blinking stops for 0.2s~0.3s). If theres no communication, communication light will be always on. If other ODU has malfunction, communication light will be on for 1s and off for 1s in a circular way.**

## ● Outdoor Unit(18/24K)

### 1. Input Parameter Compensation and Calibration

#### (1) Check the ambient temperature compensation function Indoor ambient temperature compensation function.

a. In cooling mode, the indoor ambient temperature participating in computing control = (T<sub>indoor ambient temperature</sub> - Δ T<sub>cooling indoor ambient temperature compensation</sub>)

b. In heating mode, the indoor ambient temperature participating in computing control = (T<sub>indoor ambient temperature</sub> - Δ T<sub>heating indoor ambient temperature compensation</sub>)

#### (2) Check effective judgment controls of parameters

Effective judgment function of the outdoor exhaust temperature thermo-bulb When conditions a and b are satisfied, the outdoor exhaust temperature thermo-bulb is judged not to be connected into place, the mainboard of outer units will display failure of the outdoor exhaust temperature thermo-bulb (not connected into place), stop the machine for repairing, and resume the machine by remote controls of ON/OFF.

a. Judgment of exhaust detection temperature change:

After the compressor starts up and runs for 10 minutes, if the compressor frequency  $f \geq 40\text{Hz}$ , and the rising value  $T_{\text{exhaust}}$  ( $T_{\text{exhaust}}$  (after start-up for 10 minutes) -  $T_{\text{exhaust}}$  (before start-up))  $< 2^\circ\text{C}$ , the outdoor exhaust temperature thermo-bulb can be judged not to be connected into place (judging once when the power is on the first time).

b. Comparative judgment of exhaust detection temperature and condenser detection temperature ( $T_{\text{pipe temperature}} = T_{\text{outdoor pipe temperature in cooling mode}}$ ,  $T_{\text{pipe temperature}} = T_{\text{indoor pipe temperature in heating mode}}$ ):

After the compressor starts up and runs for 10 minutes, if the compressor frequency  $f \geq 40\text{Hz}$ , and  $T_{\text{pipe temperature}} \geq (T_{\text{exhaust}} + 3)$ , the outdoor exhaust temperature thermobulb can be judged not to be connected into place (judging once when power is on the first time).

### 2. Basic Functions

#### (1) Cooling Mode

##### 1. Conditions and processes of cooling operation:

(1) If the compressor is shut down, and  $[T_{\text{set up}} - (T_{\text{indoor ambient temperature}} - \Delta T_{\text{cooling indoor ambient temperature compensation}})] \leq 0.5^\circ\text{C}$ , start up the machine for cooling, the cooling operation will start;

(2) During operations of cooling, if  $0^\circ\text{C} \leq [T_{\text{set up}} - (T_{\text{indoor ambient temperature}} - \Delta T_{\text{cooling indoor ambient temperature compensation}})] < 2^\circ\text{C}$ , the cooling operation will be still running;

(3) During operations of cooling, if  $2^\circ\text{C} \leq [T_{\text{set up}} - (T_{\text{indoor ambient temperature}} - \Delta T_{\text{cooling indoor ambient temperature compensation}})]$ , the cooling operation will stop after reaching the temperature point.

##### 2. Temperature setting range

(1) If  $T_{\text{outdoor ambient temperature}} \geq [T_{\text{low-temperature cooling temperature}}]$ , the temperature can be set at: 16~30°C (Cooling at room temperature);

(2) If  $T_{\text{outdoor ambient temperature}} < [T_{\text{low-temperature cooling temperature}}]$ , the temperature can be set at: 25~30°C (Cooling at low temperature),

that is, the minimum setting temperature for outer units judgment is 25°C .

#### (2) Dehumidifying Mode

1. Conditions and processes of dehumidifying operations: Same as the cooling mode;

2. The temperature setting range is: 16~30°C ;

#### (3) Air-supplying Mode

1. The compressor, outdoor fans and four-way valves are switched off;

2. The temperature setting range is: 16~30°C.

#### (4) Heating Mode

1. Conditions and processes of heating operations: (T<sub>indoor ambient temperature</sub> is the actual detection temperature of indoor environment thermo-bulb, T<sub>heating indoor ambient temperature compensation</sub> is the indoor ambient temperature compensation during heating operations)

(1) If the compressor is shut down, and  $[(T_{\text{indoor ambient temperature}} - \Delta T_{\text{heating indoor ambient temperature compensation}}) - T_{\text{set up}}] \leq 0.5^\circ\text{C}$ , start the machine to enter into heating operations for heating;

(2) During operations of heating, if  $0^\circ\text{C} \leq [(T_{\text{indoor ambient temperature}} - \Delta T_{\text{heating indoor ambient temperature compensation}}) - T_{\text{set up}}] < 2^\circ\text{C}$ , the heating operation will be still running;

(3) During operations of heating, if  $2^\circ\text{C} \leq [(T_{\text{indoor ambient temperature}} - \Delta T_{\text{heating indoor ambient temperature compensation}}) - T_{\text{set up}}]$ , the heating operation will stop after reaching the temperature point.

2. The temperature setting range in this mode is: 16~30°C .

### 3. Special Functions

#### Defrosting Control

① Conditions for starting defrosting

After the time for defrosting is judged to be satisfied, if the temperature for defrosting is satisfied after detections for continuous 3minutes, the defrosting operation will start.

② Conditions of finishing defrosting

The defrosting operation can exit when any of the conditions below is satisfied:

③  $T_{\text{outdoor pipe temperature}} \geq (T_{\text{outdoor ambient temperature}} - [T_{\text{temperature 1 of finishing defrosting}}])$ ;

④ The continuous running time of defrosting reaches [t<sub>max. defrosting time</sub>].

### 4. Control Logic

#### (1) Compressor Control

Start the compressor after starting cooling, heating, dehumidifying operations, and the outer fans start for 5s; When the machine is shutdown, in safety stops and when switching to air-supplying mode, the compressor will stop immediately. In all modes: once the compressor starts up, it will not be allowed to stop until having run for the [t<sub>min. compressor running time</sub>] (Note: including cases of shutdown when the temperature point is reached; except the cases requiring stopping the compressor such as fault protection, remote shutdown, mode switching etc.); In all modes: once the compressor stops, it will be allowed be restart after 3-minute delay (Note: The indoor units have a function of power memory, the machine can be restarted after remote shutdown and powering up

again without delay).

### 1. Cooling mode

Start the machine to enter into cooling operation for cooling, the compressor is switched on.

### 2. Dehumidifying mode

Same as the cooling mode.

### 3. Air-supplying mode

The compressor is switched off.

### 4. Heating mode

(1) Start the machine to enter into heating operation for heating, the compressor is switched on.

(2) Defrosting:

a. Defrosting starts: the compressor is shut down, and restarts it after 55-second delay.

b. Defrosting ends: the compressor stops, then starts it after 55-second delay.

### (2) Outer Fans Control

Notes:

Only the outer fans run for at least 80s in each air flow speed can the air flow be switched;

After the outer fans run compulsively in high speed for 80s when the machine starts up, control the air flow according to the logic.

After remote shutdown, safety stops, and when the machine stops after reaching the temperature point, as well as after the compressor stops, extend 1 minute, the outer fans will stop (During the period in the 1 minute, the air flow of outer fans can be changed according to the outdoor ambient temperature changes); When running with force, the outdoor fans shall run in the highest air flow.

### (3) 4-way valve control

1. The 4-way valve control under the modes of Cooling, dehumidification and supplying air: closing;

2. The status of 4-way valve control under the heating mode: getting power;

(1) 4-way valve power control under heating mode

Starts the machine under heating mode, the 4-way valve will get power immediately.

(2) 4-way valve power turn-off control under heating mode

a. When you should turn off the power or switch to other mode under heating mode, the power of 4-way valve will be cut after 2 minutes of the compressor stopped.

b. When all kinds of protection stops, the power of 4-way valve will be cut after delaying 4 minutes.

(3) Defrosting control under heating mode:

a. Defrosting begins: The power of 4-way valve will be cut after 50s of entering into the defrosting compressor.

b. Defrosting stops: The 4-way valve will get power after 50s of exiting the defrosting compressor.

### (4) Evaporator frozen-preventing protection function

At the mode of Cooling, dehumidifying:

Evaporator frozen-preventing protection function is allowed to begin after 6 min of starting the compressor.

#### 1. Starting estimation:

After the compressor stopped working for 180s, if  $T_{\text{inner pipe}} > [T_{\text{frozen-preventing frequency-limited temperature}}]$  (the temperature of hysteresis is 2 ), the machine is only allowed to start for operating, otherwise it should not be started, and should be stopped to treat according to the frozen-preventing protection: Clear the trouble under the mode of power turn-off / heating, and the protection times are not counted.

#### 2. Frequency limited

$[T_{\text{frozen-preventing normal speed frequency-reducing temperature}}] \leq T_{\text{inner pipe}} [T_{\text{frozen-preventing frequency-limited temperature}}]$ , you should limit the frequency raising of compressor.

#### 3. Reducing frequency at normal speed:

If  $[T_{\text{frozen-preventing high speed frequency-reducing temperature}}] \leq T_{\text{inner pipe}} [T_{\text{frozen-preventing normal speed frequency-reducing temperature}}]$ , you should adjust the compressor frequency by reducing 8Hz/90s till the lower limit;

#### 4. Reducing frequency at high speed:

If  $[T_{\text{frozen-preventing power turn-off temperature}}] \leq T_{\text{inner pipe}} [T_{\text{frozen-preventing high speed frequency-reducing temperature}}]$  you should adjust the compressor frequency by reducing 30Hz/90s till the lower limit;

#### 5. Power turn-off:

If the  $T_{\text{inner pipe}} < [T_{\text{frozen-preventing power turn-off temperature}}]$ , then frozen-preventing protect to stop the machine; If  $T_{\text{frozen-preventing frequency-limited temperature}} < T_{\text{inner pipe}}$ , and the compressor has stopped working for 3 minutes, the whole machine should be allowed to operate.

6. If the frozen-preventing protection power turn-off continuously occurs for six times, it should not be resumed automatically, and you should press the ON/OFF button to resume if the fault keeps on. During the process of running, if the running time of compressor exceeds the t evaporator frozen-preventing protection times zero clearing time, the times of frozen-preventing power turn-off should be cleared to recount. The mode of stopping the machine or transferring to supply air will clear the trouble times immediately (if the trouble can not be resumed, mode transferring will not clear it).

### (5) Overload protection function

Overload protection function at the mode of cooling and dehumidifying

#### 1. Starting estimation:

After the compressor stopped working for 180s, if  $T_{\text{outer pipe}} < [T_{\text{Cooling overload frequency-limited temperature}}]$  (the temperature of hysteresis is 2°C), the machine is allowed to start, otherwise it should not be started, and should be stopped to treat according to the overload protection: Clear the trouble at the mode of power turn-off / heating, and the protection times are not counted.

#### 2. Frequency limited

If  $[T_{\text{Cooling overload frequency-limited temperature}}] \leq T_{\text{outer pipe}} [T_{\text{Cooling overload frequency reducing temperature at normal speed}}]$ , you should limit the frequency raising of compressor.

#### 3. Reducing frequency at normal speed and power turn-off:

If  $[T_{\text{Cooling overload frequency reducing temperature at high speed}}] \leq T_{\text{outer pipe}} < [T_{\text{Cooling overload power turn-off temperature}}]$ , you should adjust the compressor frequency by reducing 8Hz/90s till the lower limit; After it was

running 90s at the lower limit, if  $[T_{\text{Cooling overload frequency reducing temperature at normal speed}}] \leq T_{\text{outer pipe}}$ , then Cooling overload protects machine stopping;

#### 4. Reducing frequency at high speed and stop machine:

If  $[T_{\text{Cooling overload frequency reducing temperature at high speed}}] \leq T_{\text{outer pipe}}$   $[T_{\text{Cooling overload power turn-off temperature}}]$ , you should adjust the compressor frequency by reducing 30Hz/90s till the lower limit; After it was running 90s at the lower limit, if  $[T_{\text{Cooling overload frequency reducing temperature at normal speed}}] \leq [T_{\text{outer pipe}}]$ , then Cooling overload protects machine stopping;

#### 5. Power turn-off:

If the  $[T_{\text{Cooling overload power turn-off temperature}}] \leq T_{\text{outer pipe}}$ , then Cooling overload protects machine stopping; If  $[T_{\text{outer pipe}}] < [T_{\text{Cooling overload frequency-limited temperature}}]$  and the compressor has been stopped working for 3 minutes, the machine should be allowed to operate.

6. If the Cooling overload protection power turn-off continuously occurs for six times, it should not be resumed automatically, and you should press the ON/OFF button to resume if the fault keeps on. During the process of running, if the running time of compressor exceeds the t overload protection times zero clearing time, the times of overload protection power turn-off should be cleared to recount. The mode of stopping the machine or transferring to supply air will clear the trouble times immediately (if the trouble can not be resumed, transferring mode will not clear it).

### Overload protection function at the mode of heating

#### Starting estimation :

After the compressor stopped working for 180s, if T inner pipe T heating overload frequency-limited temperature (the temperature of hysteresis is 2 ), the machine is allowed to start, otherwise it should not be started, and should be stopped to treat according to the overload protection:

Clear the trouble at the mode of power turn-off / heating, and the protection times are not counted.

#### 1. Frequency limited

If  $[T_{\text{heating overload frequency-limited temperature}}] \leq T_{\text{inner pipe}} < [T_{\text{heating overload frequency reducing temperature at normal speed}}]$ , you should limit the frequency raising of compressor.

#### 2. Reducing frequency at normal speed and stopping machine:

If  $[T_{\text{heating overload frequency reducing temperature at normal speed}}] \leq T_{\text{inner pipe}} < [T_{\text{heating overload frequency reducing temperature at high speed}}]$ , you should adjust the compressor frequency by reducing 8Hz/90s till the lower limit; After it was running 90s at the lower limit, if  $T_{\text{heating overload frequency reducing temperature at normal speed}} \leq T_{\text{inner pipe}}$ , then overload protects machine stopping;

#### 3. Reducing frequency at high speed and power turn-off:

If  $[T_{\text{heating overload frequency reducing temperature at high speed}}] \leq T_{\text{inner pipe}} < [T_{\text{heating overload power turn-off temperature}}]$ , you should adjust the compressor frequency by reducing 30Hz/90s till the lower limit; After it was running 90s at the lower limit, if T heating overload frequency reducing temperature at normal speed  $\leq T_{\text{outer pipe}}$ , then Cooling overload protects machine stopping;

#### 4. Power turn-off:

If the  $[T_{\text{heating overload power turn-off temperature}}] \leq T_{\text{inner pipe}}$ , then overload protects machine stopping; If T inner pipe T heating overload frequency-limited temperature and the compressor has been stopped working for 3 minutes, the machine should be allowed to operate.

5. If the overload protection power turn-off continuously occurs for six times, it should not be resumed automatically, and you should press the ON/OFF button to resume if the fault keeps on. During the process of running, if the running time of compressor exceeds the t overload protection times zero clearing time, the times of overload protection power turn-off should be cleared to recount. The mode of stopping the machine or transferring to supply air will clear the trouble times immediately (if the trouble can not be resumed, transferring mode will not clear it). Protective function for discharge temperature of compressor

#### 1. Starting estimation:

After the compressor stopped working for 180s, if  $T_{\text{Discharge}} < T_{\text{Discharge limited temperature}}$  (the temperature of hysteresis is 2°C ), the machine is allowed to start, otherwise it should not be started, and should be stopped to treat according to the discharge temperature:

The machine should be stopped or transferred to supply air, the trouble should be cleared immediately, and the protection times are not counted.

#### 2. Frequency limited

If  $[T_{\text{limited frequency temperature during discharging}}] \leq T_{\text{Discharge}} < [T_{\text{frequency reducing temperature at normal speed during discharging}}]$ , you should limit the frequency raising of compressor.

#### 3. Reducing frequency at normal speed and stopping machine:

If  $[T_{\text{frequency reducing temperature at normal speed during discharging}}] \leq T_{\text{Discharge}} < [T_{\text{frequency reducing temperature at high speed during discharging}}]$ , you should adjust the compressor frequency by reducing 8Hz/90s till the lower limit; After it was running 90s at the lower limit, if  $[T_{\text{frequency reducing temperature at normal speed during discharging}}] \leq T_{\text{Discharge}}$ , you should discharge to protect machine stopping;

#### 4. Reducing frequency at high speed and power turn-off:

If  $[T_{\text{frequency reducing temperature at high speed during discharging}}] \leq T_{\text{Discharge}} < [T_{\text{stop temperature during discharging}}]$ , you should adjust the compressor frequency by reducing 30Hz/90s till the lower limit; After it was running 90s at the lower limit, if  $[T_{\text{frequency reducing temperature at normal speed during discharging}}] \leq T_{\text{Discharge}}$ , you should discharge to protect machine stopping;

#### 5. Power turn-off:

If the  $[T_{\text{Power turn-off temperature during discharging}}] \leq T_{\text{Discharge}}$ , you should discharge to protect machine stopping; If  $[T_{\text{Discharge}}] < [T_{\text{limited frequency temperature during discharging}}]$  and the compressor has been stopped for 3 minutes, the machine should be allowed to operate.

6. If the discharging temperature protection of compressor continuously occurs for six times, it should not be resumed automatically, and you should press the ON/OFF button to resume. During the process of running, if the running time of

compressor exceeds the  $t_{\text{Protection times clearing of discharge}}$ , the discharge protection is cleared to recount. Stopped or transferred to supply air mode will clear the trouble times immediately (if the trouble can not be resumed, mode transferring also will not clear it).

### 7. Frequency limited

If  $[I_{\text{Limited frequency when overcurrent}}] \leq [I_{\text{AC Electric current}}] < [I_{\text{frequency reducing when overcurrent}}]$ , you should limit the frequency raising of compressor.

### 8. Reducing frequency:

If  $[I_{\text{Frequency reducing when overcurrent}}] \leq [I_{\text{AC Electric current}}]$  Power turn-off when overcurrent, you should reduce the compressor frequency till the lower limit or exit the frequency reducing condition;

### 9. Power turn-off:

If  $[I_{\text{Power turn-off machine when overcurrent}}] \leq [I_{\text{AC Electric current}}]$ , you should carry out the overcurrent stopping protection; If  $I_{\text{AC Electric current}} < [T_{\text{Limited frequency when overcurrent}}]$  and the compressor has been stopped for 3 minutes, the machine should be allowed to operate.

10. If the overcurrent protection continuously occurs for six times, it should not be resumed automatically, and you should press the ON/OFF button to resume. During the process of running, if the running time of compressor exceeds the  $[t_{\text{Protection times clearing of over current}}]$ , the discharge protection is cleared to recount.

### (6)Voltage sag protection

After start the compressor, if the time of DC link Voltage sag  $[U_{\text{Sagging protection voltage}}]$  is measured to be less than  $t_{\text{Voltage sag protection time}}$ , the machine should be stop at once, hand on the voltage sag trouble, reboot automatically after 30 minutes.

### (7)Communication fault

When you have not received any correct signal from the inner machine in three minutes, the machine will stop for communication fault. When you have not received any correct signal from driver IC (aim to the controller for the separating of main control IC and driver IC), and the machine will stop for communication fault. If the communication is resumed, the machine will be allowed to operate.

### (8)Module protection

Testing the module protective signal immediately after started, once the module protective signal is measured, stop the machine with module protection immediately. If the module protection is resumed, the machine will be allowed to operate. If the module protection continuously occurs for three times, it should not be resumed automatically, and you should press the ON/OFF button to resume. If the running time of compressor exceeds the  $[t_{\text{Protection times clearing of module}}]$ , the module protection is cleared to recount.

### (9)Module overheating protection

#### 1. Starting estimation:

After the compressor stopped working for 180s, if  $T_{\text{Module}} < [T_{\text{Module frequency limited temperature}}]$  (the temperature of hysteresis is 2), the machine is allowed to start, otherwise it should not be started, and should be stopped to treat according to the module overheating protection: The machine should be stopped or transferred to supply air, the trouble should be cleared immediately, and the protection times are not counted.

### 2. Frequency limited

If  $[T_{\text{Limited frequency temperature of module}}] \leq T_{\text{Module}} < [T_{\text{frequency reducing temperature at normal speed of module}}]$ , you should limit the frequency raising of compressor.

### 3. Reducing frequency at normal speed and power turn-off:

If  $[T_{\text{frequency reducing temperature at normal speed of module}}] \leq T_{\text{Module}} < [T_{\text{frequency reducing temperature at high speed of module}}]$ , you should adjust the compressor frequency by reducing 8Hz/90s till the lower limit; After it was running 90s at the lower limit, if  $[T_{\text{frequency reducing temperature at normal speed of module}}] \leq T_{\text{Module}}$ , you should stop the machine for module overheating protection;

### 4. Reducing frequency at high speed and power turn-off:

If  $[T_{\text{frequency reducing temperature at high speed of module}}] \leq T_{\text{Module}} < [T_{\text{Power turn-off temperature of module}}]$  you should adjust the compressor frequency by reducing 30Hz/90s till the lower limit; After it was running 90s at the lower limit, if  $[T_{\text{frequency reducing temperature at normal speed of module}}] \leq T_{\text{Module}}$ , you should stop the machine for module overheating protection;

### 5. Power turn-off:

If the  $[T_{\text{Power turn-off temperature of module}}] \leq T_{\text{Module}}$ , you should stop the machine for module overheating protection; If  $T_{\text{Module}} < [T_{\text{Limited frequency temperature of module}}]$  and the compressor has been stopped for 3 minutes, the machine should be allowed to operate.

6. If protection continuously occurs for six times, it should not be resumed automatically, and you should press the ON/OFF button to resume. During the process of running, if the running time of compressor exceeds the  $[t_{\text{Protection times clearing of module}}]$ , the discharge protection is cleared to recount. Stopped or transferred to supply air mode will clear the trouble times immediately (if the trouble can not be resumed, mode transferring also will not clear it).

### (10)Compressor overloads protection

If you measure the compressor overload switch action in 3s, the compressor should be stopped for overloading. The machine should be allowed to operate after overload protection was measured to resume. If the overloading protection continuously occurs for three times, it should not be resumed automatically, and you should press the ON/OFF button to resume. The protection times of compressor is allowed to clear after the compressor run  $[t_{\text{Protection times clearing of compressor overloading}}]$  30 minutes.

### (11)Phase current overcurrent protection of compressor

During the running process of compressor, you could measure the phase current of the compressor, and control it according to the following steps:

#### 1. Frequency limited

If  $[I_{\text{Limited frequency phase current}}] \leq [I_{\text{Phase current T frequency reducing phase current}}]$ , you should limit the frequency raising of compressor.

#### 2. Reducing Frequency

If  $[I_{\text{Frequency Reducing Phase Current}}] \leq [I_{\text{Phase Current}}] < [I_{\text{Power Turn-Off Phase Current}}]$ , the compressor shall continue to reduce frequency till the lowest frequency limit or out of the condition of reducing frequency;

#### 3. Power turn-off

If  $[I_{\text{Phase Current}}] \geq [I_{\text{Power Turn-Off Phase Current}}]$ , the compressor phase current shall stop working for overcurrent protection; if  $[I_{\text{Phase Current}}] \leq [I_{\text{Frequency Reducing Phase Current}}]$ , and the compressor have stopped working for 3 min, the machine shall be allowed to operate;

4. If the overcurrent protection of compressor phase current continuously occurs for six times, it should not be resumed automatically, and you should press the ON/OFF button to resume. During the process of running, if the running time of compressor exceeds the [t<sub>Clearing Time of Compressor Phase Current Times</sub>], the overcurrent protection is cleared to recount.

#### (12) Starting-up Failure Protection for Compressor

Stop the compressor after it's starting-up fails, restart it after 20s if the fault doesn't show, and if they are all failing for the successive start 3 times, it shall be reported as Starting-up Failure, and then restart it after 3 min. When it still not be able to operate through carry out the above process for 5 times, it is available if press ON/OFF. And the compressor should be cleared the times after it run 2 min.

#### (13) Out-of-Step Protection for Compressor

The out-of-step protection signal should be detected immediately after starting-up compressor, and once find the out-of-step protection signal, the out-of-step protection shall be stopped; if it can run for lasting power turn-off 3 min, the machine shall be allowed to operate. If it still can't run automatically when the out-of-step protection for compressor happens to stop working for 6 times in succession, it needs to press ON/OFF to operate. And if the running time is more than 10 min, the power turn-off times for out-of-step protection shall be cleared and recounted.

#### (14) Voltage Abnormity Protection for DC Bus

To detect voltage abnormity protection for dc bus after completing the pre-charge:

##### 1. Over-High Voltage Protection for DC Bus:

If it found the DCbus voltage  $U_{DC} > [U_{DC \text{ Jiekuangchun Protection}}]$ , turn off PFC and stop the compressor at once, and it shall show the DC over-high voltage failure; it should clear out the failure when the voltage dropped to  $U_{DC} < [U_{DC \text{ Jiekuangchun Recovery}}]$  and the compressor stopped for 3 min.

##### 2. Over-Low Voltage Protection for DC Bus:

If it found the DC bus voltage  $U_{DC} < [U_{DC \text{ Wantuochun Protection}}]$ , turn off PFC and stop the compressor at once, and it shall show the DC over-low voltage; and it should clear out the failure when the voltage raised to  $U_{DC} > [U_{DC \text{ Wantuochun Recovery}}]$  and the compressor stopped for 3 min.

##### 3. To detect voltage abnormity protect for DC bus when getting electricity:

If it found the DC bus voltage  $U_{DC} > [U_{DC \text{ Over-High Voltage}}]$ , turn off the relay at once, and shows voltage abnormity failure for DC Bus. And the failure can't recover except to break off and get the electricity.

#### (15) Abnormity Protection for Four-way Valve

Under the model of heating operation in good condition: the compressor is detected  $[T_{\text{Inner Tube}} < (T_{\text{Inner Ring}} - T_{\text{Abnormity Temperature Difference For Four-Way Valve Reversion}})]$ , during the running, it should be regarded as four-way valve reversion abnormity. And then it can run if stop the reversion abnormity protection for four-way valve 3 min; and if it still can't run when the reversion abnormity protection for four-way valve happens to stop working for 3 times in succession, it is

available if presses ON/OFF.

Attention: the protection shall be shielded during the testing mode and defrosting process, and it shall be cleared out the failure and it's times immediately when turning off or delivering wind / cooling / dehumidifying mode conversed (the inverted mode Don't clear out the failure when it can't recover to operate).

#### (16) PFC Protection

1. After start up the PFC, it should detect the protection signal of PFC immediately; under the condition of PFC protection, it should turn off the PFC and compressor at one time;
2. It shows the failure is cleared out if PFC Protection stopped working 3 min and recovers to run automatically;
3. If it still can't run when it occurs PFC protection for 3 times in succession, it is available if presses ON/OFF; and clear the PFC Protection times when start up PFC for 10min.

#### (17) Failure Detection for Sensor

1. Outdoor Ambient Sensor: detect the failure of sensor at all times.
2. Outdoor Tube Sensor: You should not detect the failure of outdoor tube sensor within 10 minutes heating operation compressor except the defrosting, and you could detect it at other time.
3. Outdoor Exhaust Sensor:
  - (a) The compressor only detect the sensor failure after it start up 3 min in normal mode;
  - (b) It should detect the exhaust sensor failure immediately in the testing mode.
4. Module Temperature Sensor:
  - (a) Short-Circuit Detection: the compressor should be detected immediately when the module temperature sensor occurs short-circuits;
  - (b) Open-Circuit Detection: the compressor should be detected on open-circuit when it runs 3min (it neednt 30s avoiding the module over-heated).
  - (c) Detect the sensor failure at all times in the testing mode.
5. Disposal for Sensor Protection
  - (1) When the short-circuit of sensor is detected within 30s, It is regarded as the temperature of sensor over-high (or infinitely high), and now according to the over-high sensor, the machine should carry out the corresponding protection to stop working, and show the corresponding temperature shutdown protection and sensor failure at the same time (for example: the compressor stops immediately when the outdoor tube sensor short-circuit, and the machine shall show the overload protection and outdoor tube sensor failure).
  - (2) When the open-circuit of sensor is detected within 30s, The protection shall be stopped and it shall show the corresponding sensor failure.
6. Electric Heating Function of Chassis
  - (1) When  $T_{\text{outdoor amb.}} \leq 0^{\circ}\text{C}$ , the electric heating of chassis will operate;
  - (2) When  $T_{\text{outdoor amb.}} > 2^{\circ}\text{C}$ , the electric heating of chassis will stop operation;

(3) When  $0^{\circ}\text{C} < T_{\text{outdoor amb.}} \leq 2^{\circ}\text{C}$ , the electric heating of chassis will keep original status.

#### 7. Electric Heating Function of Compressor

(1) When  $T_{\text{outdoor amb.}} \leq -5^{\circ}\text{C}$ , compressor stops operation, while the electric heating of compressor starts operation;

(2) When  $T_{\text{outdoor amb.}} > -2^{\circ}\text{C}$ , the electric heating of compressor stops operation;

(3) When  $-5^{\circ}\text{C} < T_{\text{outdoor amb.}} \leq -2^{\circ}\text{C}$ , the electric heating of compressor will keep original status.



## 6.3 Ewpe Smart App Operation Manual

### Control Flow Chart

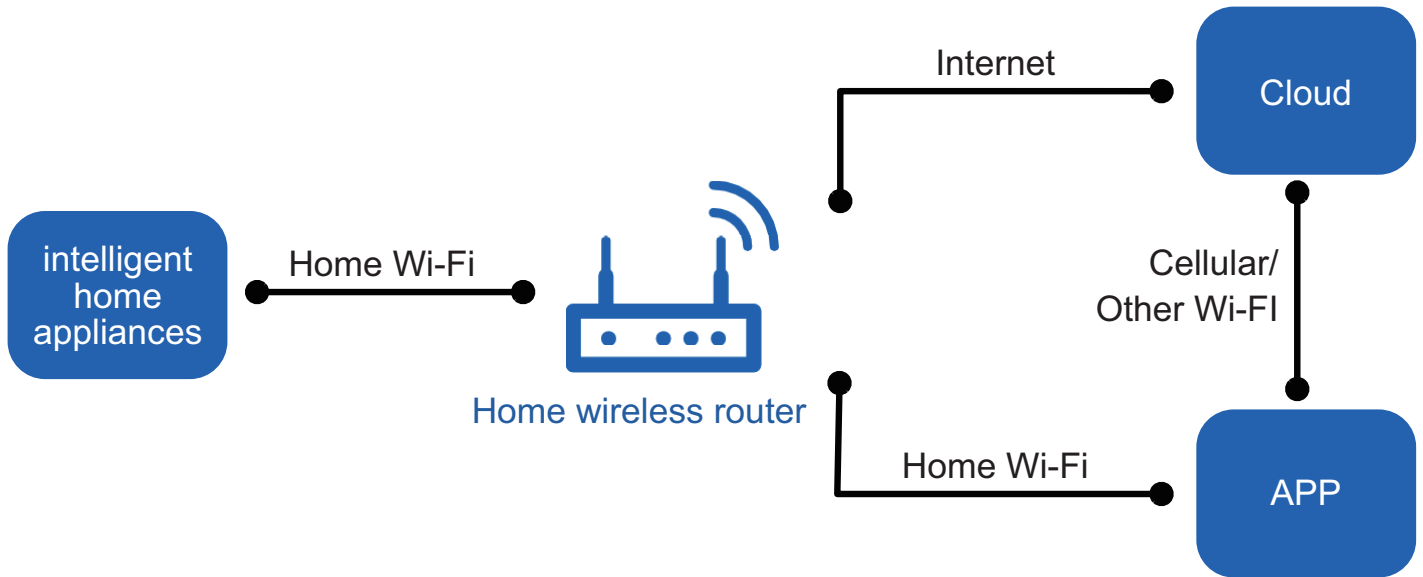

### Operating Systems

Requirement for User's smart phone:



iOS system  
Support iOS7.0 and  
above version



Android system  
Support Android 4.4 and  
above version

### Download and installation



App Download Linkage

Scan the QR code or search "Ewpe Smart" in the application market to download and install it. When "Ewpe Smart" App is installed, register the account and add the device to achieve long-distance control and LAN control of smart home appliances. For more information, please refer to "Help" in App.

# 7. Notes for Installation and Maintenance

## Safety Precautions: Important!

Please read the safety precautions carefully before installation and maintenance.

The following contents are very important for installation and maintenance.

Please follow the instructions below.

- The installation or maintenance must accord with the instructions.
- Comply with all national electrical codes and local electrical codes.
- Pay attention to the warnings and cautions in this manual.
- All installation and maintenance shall be performed by distributor or qualified person.
- All electric work must be performed by a licensed technician according to local regulations and the instructions given in this manual.
- Be caution during installation and maintenance. Prohibit incorrect operation to prevent electric shock, casualty and other accidents.



## WARNINGS

### Electrical Safety Precautions:

1. Cut off the power supply of air conditioner before checking and maintenance.
2. The air condition must apply specialized circuit and prohibit share the same circuit with other appliances.
3. The air conditioner should be installed in suitable location and ensure the power plug is touchable.
4. Make sure each wiring terminal is connected firmly during installation and maintenance.
5. Have the unit adequately grounded. The grounding wire cant be used for other purposes.
6. Must apply protective accessories such as protective boards, cable-cross loop and wire clip.
7. The live wire, neutral wire and grounding wire of power supply must be corresponding to the live wire, neutral wire and grounding wire of the air conditioner.
8. The power cord and power connection wires cant be pressed by hard objects.
9. If power cord or connection wire is broken, it must be replaced by a qualified person.
10. If the power cord or connection wire is not long enough, please get the specialized power cord or connection wire from the manufacture or distributor. Prohibit prolong the wire by yourself.

11. For the air conditioner without plug, an air switch must be installed in the circuit. The air switch should be all-pole parting and the contact parting distance should be more than 3mm.

12. Make sure all wires and pipes are connected properly and the valves are opened before energizing.

13. Check if there is electric leakage on the unit body. If yes, please eliminate the electric leakage.

14. Replace the fuse with a new one of the same specification if it is burnt down; dont replace it with a cooper wire or conducting wire.

15. If the unit is to be installed in a humid place, the circuit breaker must be installed.

### Installation Safety Precautions:

1. Select the installation location according to the requirement of this manual.(See the requirements in installation part)
2. Handle unit transportation with care; the unit should not be carried by only one person if it is more than 20kg.
3. When installing the indoor unit and outdoor unit, a sufficient fixing bolt must be installed; make sure the installation support is firm.
4. Ware safety belt if the height of working is above 2m.
5. Use equipped components or appointed components during installation.
6. Make sure no foreign objects are left in the unit after finishing installation.

### Refrigerant Safety Precautions:

1. When refrigerant leaks or requires discharge during installation, maintenance, or disassembly, it should be handled by certified professionals or otherwise in compliance with local laws and regulations.
- 2.Avoid contact between refrigerant and fire as it generates poisonous gas; Prohibit prolong the connection pipe by welding.
3. Apply specified refrigerant only. Never have it mixed with any other refrigerant. Never have air remain in the refrigerant line as it may lead to rupture or other hazards.
4. Make sure no refrigerant gas is leaking out when installation is completed.
5. If there is refrigerant leakage, please take sufficient measure to minimize the density of refrigerant.
6. Never touch the refrigerant piping or compressor without wearing glove to avoid scald or frostbite.

**Improper installation may lead to fire hazard, explosion, electric shock or injury.**

# Safety Precautions for Installing and Relocating the Unit:

To ensure safety, please be mindful of the following precautions.

## WARNINGS

**1. When installing or relocating the unit, be sure to keep the refrigerant circuit free from air or substances other than the specified refrigerant.**

Any presence of air or other foreign substance in the refrigerant circuit will cause system pressure rise or compressor rupture, resulting in injury.

**2. When installing or moving this unit, do not charge the refrigerant which is not comply with that on the nameplate or unqualified refrigerant.**

Otherwise, it may cause abnormal operation, wrong action, mechanical malfunction or even series safety accident.

**3. When refrigerant needs to be recovered during relocating or repairing the unit, be sure that the unit is running in cooling mode. Then, fully close the valve at high pressure side (liquid valve). About 30-40 seconds later, fully close the valve at low pressure side (gas valve), immediately stop the unit and disconnect power. Please note that the time for refrigerant recovery should not exceed 1 minute.**

If refrigerant recovery takes too much time, air may be sucked in and cause pressure rise or compressor rupture, resulting in injury.

**4. During refrigerant recovery, make sure that liquid valve and gas valve are fully closed and power is disconnected before detaching the connection pipe.**

If compressor starts running when stop valve is open and connection pipe is not yet connected, air will be sucked in and cause pressure rise or compressor rupture, resulting in injury.

**5. When installing the unit, make sure that connection pipe is securely connected before the compressor starts running.**

If compressor starts running when stop valve is open and connection pipe is not yet connected, air will be sucked in and cause pressure rise or compressor rupture, resulting in injury.

**6. Prohibit installing the unit at the place where there may be leaked corrosive gas or flammable gas.**

If there leaked gas around the unit, it may cause explosion and other accidents.

**7. Do not use extension cords for electrical connections. If the electric wire is not long enough, please contact a local service center authorized and ask for a proper electric wire.**

Poor connections may lead to electric shock or fire.

**8. Use the specified types of wires for electrical connections between the indoor and outdoor units. Firmly clamp the wires so that their terminals receive no external stresses.**

Electric wires with insufficient capacity, wrong wire connections and insecure wire terminals may cause electric shock or fire.

## Safety Precautions for Refrigerant

- To realize the function of the air conditioner unit, a special refrigerant circulates in the system. The used refrigerant is the fluoride R32, which is specially cleaned. The refrigerant is flammable and odorless. Furthermore, it can lead to explosion under certain conditions. But the flammability of the refrigerant is very low. It can be ignited only by fire.
- Compared to common refrigerants, R32 is a nonpolluting refrigerant with no harm to the ozone layer. The influence upon the greenhouse effect is also lower. R32 has got very good thermodynamic features which lead to a really high energy efficiency. The units therefore need a less filling.

### WARNING:

- Do not use means to accelerate the defrosting process or to clean, other than those recommended by the manufacturer. Should repair be necessary, contact your nearest authorized Service Centre. Any repairs carried out by unqualified personnel may be dangerous. The appliance shall be stored in a room without continuously operating ignition sources. (for example: open flames, an operating gas appliance or an operating electric heater.)
- Do not pierce or burn.
- Appliance shall be installed, operated and stored in a room with a floor area larger than  $Xm^2$ .
- Appliance filled with flammable gas R32. For repairs, strictly follow manufacturer's instructions only. Be aware that refrigerants do not contain odor.
- Read specialist's manual.

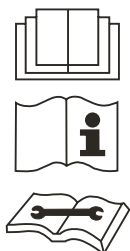

## Safety Operation of Flammable Refrigerant

### Qualification requirement for installation and maintenance man

- All the workmen who are engaged in the refrigeration system should bear the valid certification awarded by the authoritative organization and the qualification for dealing with the refrigeration system recognized by this industry. If it needs other technician to maintain and repair the appliance, they should be supervised by the person who bears the qualification for using the flammable refrigerant.
- It can only be repaired by the method suggested by the equipment's manufacturer.

## Installation notes

- The air conditioner is not allowed to use in a room that has running fire (such as fire source, working coal gas stove, operating heater).
- It is not allowed to drill hole or burn the connection pipe.
- The air conditioner must be installed in a room that is larger than the minimum room area. The minimum room area is shown on the nameplate or following table a.
- Leak test is a must after installation.

table a - Minimum room area ( m<sup>2</sup> )

Charge amount (kg)	floor location	window mounted	wall mounted	ceiling mounted
≤1.2	/	/	/	/
1.3	14.5	5.2	1.6	1.1
1.4	16.8	6.1	1.9	1.3
1.5	19.3	7	2.1	1.4
1.6	22	7.9	2.4	1.6
1.7	24.8	8.9	2.8	1.8
1.8	27.8	10	3.1	2.1
1.9	31	11.2	3.4	2.3
2	34.3	12.4	3.8	2.6
2.1	37.8	13.6	4.2	2.8
2.2	41.5	15	4.6	3.1
2.3	45.4	16.3	5	3.4
2.4	49.4	17.8	5.5	3.7
2.5	53.6	19.3	6	4

## Maintenance notes

- Check whether the maintenance area or the room area meet the requirement of the nameplate.
  - Its only allowed to be operated in the rooms that meet the requirement of the nameplate.
- Check whether the maintenance area is well-ventilated.
  - The continuous ventilation status should be kept during the operation process.
- Check whether there is fire source or potential fire source in the maintenance area.
  - The naked flame is prohibited in the maintenance area; and the “no smoking” warning board should be hanged.
- Check whether the appliance mark is in good condition.
  - Replace the vague or damaged warning mark.

## Welding

- If you should cut or weld the refrigerant system pipes in the process of maintaining, please follow the steps as below:
  - a. Shut down the unit and cut power supply
  - b. Eliminate the refrigerant
  - c. Vacuuming
  - d. Clean it with N<sub>2</sub> gas
  - e. Cutting or welding

f. Carry back to the service spot for welding

- Make sure that there isn't any naked flame near the outlet of the vacuum pump and it's well-ventilated.
- The refrigerant should be recycled into the specialized storage tank.

#### **Filling the refrigerant**

- Use the refrigerant filling appliances specialized for R32. Make sure that different kinds of refrigerant won't contaminate with each other.
- The refrigerant tank should be kept upright at the time of filling refrigerant.
- Stick the label on the system after filling is finished (or haven't finished).
- Don't overfilling.
- After filling is finished, please do the leakage detection before test running; another time of leak detection should be done when it's removed.

#### **Safety instructions for transportation and storage**

- Please use the flammable gas detector to check before unload and open the container.
- No fire source and smoking.
- According to the local rules and laws.

# Main Tools for Installation and Maintenance



Level meter



Measuring tape



Screw driver



Impact drill



Drill head



Electric drill



Electroprobe



Universal meter



Torque wrench



Open-end wrench



Inner hexagon spanner



Electronic leakage detector



Vacuum pump



Pressure meter



Pipe pliers



Pipe pliers



Pipe cutter



Pipe expander



Pipe bender



Soldering appliance



Refrigerant container



Electronic scale

# 8. Installation

## 8.1 Installation Dimension Diagram

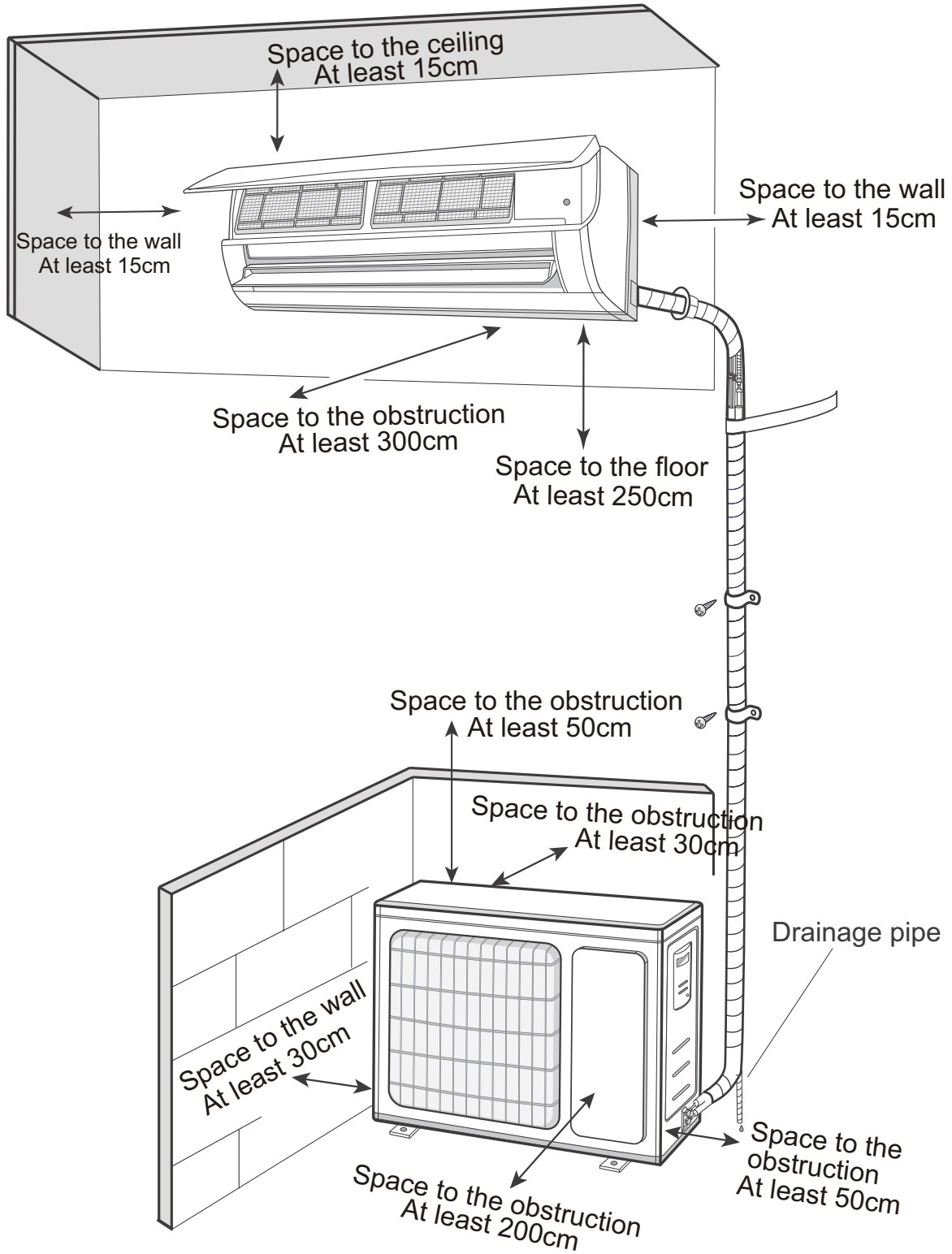

## Installation Procedures

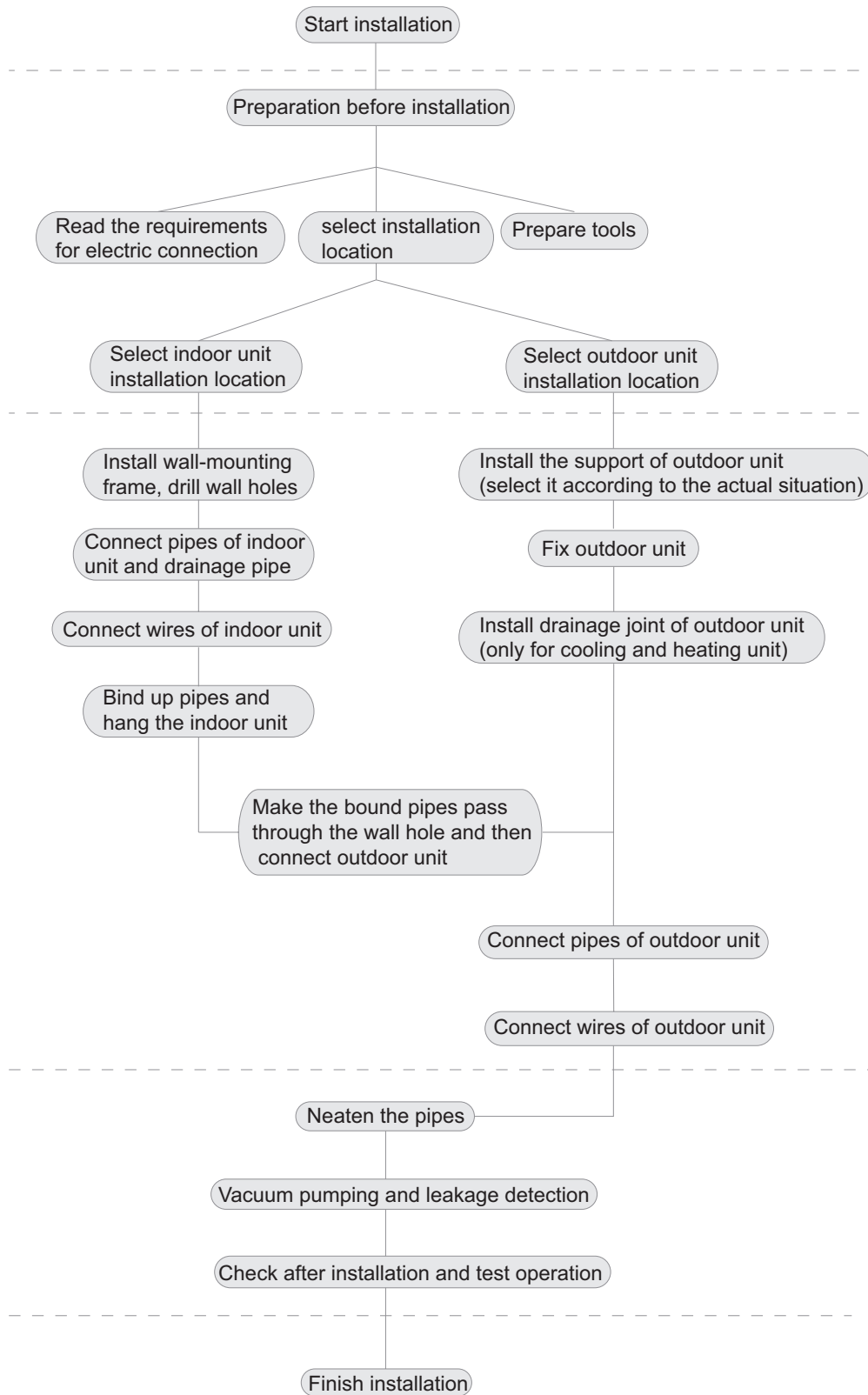

Note: this flow is only for reference; please find the more detailed installation steps in this section.



## 8.2 Installation Parts-checking

No.	Name
1	Indoor unit
2	Outdoor unit
3	Connection pipe
4	Drainage pipe
5	Wall-mounting frame
6	Connecting cable(power cord)
7	Wall pipe
8	Sealing gum
9	Wrapping tape
10	Support of outdoor unit
11	Fixing screw
12	Drainage plug(cooling and heating unit)
13	Owners manual, remote controller

### ⚠ Note:

- 1.Please contact the local agent for installation.
- 2.Dont use unqualified power cord.

## 8.3 Selection of Installation Location

### 1. Basic Requirement:

Installing the unit in the following places may cause malfunction. If it is unavoidable, please consult the local dealer:

- (1) The place with strong heat sources, vapors, flammable or explosive gas, or volatile objects spread in the air.
- (2) The place with high-frequency devices (such as welding machine, medical equipment).
- (3) The place near coast area.
- (4) The place with oil or fumes in the air.
- (5) The place with sulfured gas.
- (6) Other places with special circumstances.
- (7) The appliance shall not be installed in the laundry.
- (8) It's not allowed to be installed on the unstable or motive base structure(such as truck) or in the corrosive environment (such as chemical factory).

### 2. Indoor Unit:

- (1) There should be no obstruction near air inlet and air outlet.
- (2) Select a location where the condensation water can be dispersed easily and wont affect other people.
- (3) Select a location which is convenient to connect the outdoor unit and near the power socket.
- (4) Select a location which is out of reach for children.
- (5) The location should be able to withstand the weight of indoor unit and wont increase noise and vibration.
- (6) The appliance must be installed 2.5m above floor.
- (7) Dont install the indoor unit right above the electric appliance.
- (8) Please try your best to keep way from fluorescent lamp.

### 3. Outdoor Unit:

- (1) Select a location where the noise and outflow air emitted by the outdoor unit will not affect neighborhood.
- (2) The location should be well ventilated and dry, in which the outdoor unit wont be exposed directly to sunlight or strong wind.
- (3) The location should be able to withstand the weight of outdoor unit.
- (4) Make sure that the installation follows the requirement of installation dimension diagram.
- (5) Select a location which is out of reach for children and far away from animals or plants.If it is unavoidable, please add fence for safety purpose.

## 8.4 Electric Connection Requirement

### 1. Safety Precaution

- (1) Must follow the electric safety regulations when installing the unit.
- (2) According to the local safety regulations, use qualified power supply circuit and air switch.
- (3) Make sure the power supply matches with the requirement of air conditioner. Unstable power supply or incorrect wiring may result in electric shock,fire hazard or malfunction. Please install proper power supply cables before using the air conditioner.
- (4) Properly connect the live wire, neutral wire and grounding wire of power socket.
- (5) Be sure to cut off the power supply before proceeding any work related to electricity and safety.
- (6) Do not put through the power before finishing installation.
- (7) If the supply cord is damaged, it must be replaced by the manufacturer, its service agent or similarly qualified persons in order to avoid a hazard .
- (8) The temperature of refrigerant circuit will be high, please keep the interconnection cable away from the copper tube.
- (9) The appliance shall be installed in accordance with national wiring regulations.

### 2. Grounding Requirement:

- (1) The air conditioner is the first class electric appliance.It must be properly grounding with specialized grounding device by a professional.

Please make sure it is always grounded effectively,otherwise it may cause electric shock.

- (2) The yellow-green wire in air conditioner is grounding wire, which cant be used for other purposes.
- (3) The grounding resistance should comply with national electric safety regulations.
- (4) The appliance must be positioned so that the plug is accessible.
- (5) An all-pole disconnection switch having a contact separation of at least 3mm in all poles should be connected in fixed wiring.
- (6) Including an air switch with suitable capacity, please note the following table. Air switch should be included magnet buckle and heating buckle function, it can protect the circuit-short and overload. (Caution: please do not use the fuse only for protect the circuit)

Model	Air switch capacity	Power cord
09/12K	10A	3G1.0
18K	16A	3G1.5
24K	25A	3G2.5

## 8.5 Installation of Indoor Unit

### 1. Choosing Installation location

Recommend the installation location to the client and then confirm it with the client.

### 2. Install Wall-mounting Frame

(1) Hang the wall-mounting frame on the wall; adjust it in horizontal position with the level meter and then point out the screw fixing holes on the wall.

(2) Drill the screw fixing holes on the wall with impact drill (the specification of drill head should be the same as the plastic expansion particle) and then fill the plastic expansion particles in the holes.

(3) Fix the wall-mounting frame on the wall with tapping screws and then check if the frame is firmly installed by pulling the frame. If the plastic expansion particle is loose, please drill another fixing hole nearby.

### 3. Install Wall-mounting Frame

(1) Choose the position of piping hole according to the direction of outlet pipe. The position of piping hole should be a little lower than the wall-mounted frame, shown as below. (As show in Fig.1)

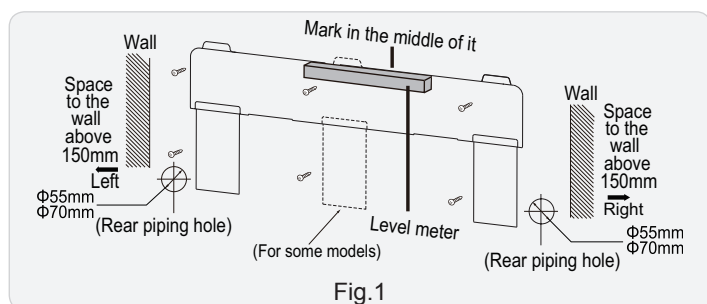

(2) Open a piping hole with the diameter of  $\Phi 55\text{mm}$  or  $\Phi 70\text{mm}$  on the selected outlet pipe position. In order to drain smoothly, slant the piping hole on the wall slightly downward to the outdoor side with the gradient of  $5-10^\circ$ . (As show in Fig.2)

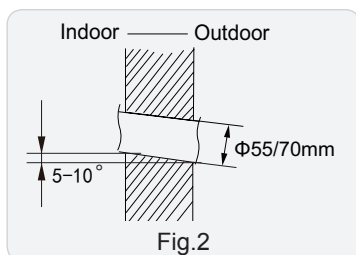

#### ⚠ Note:

Pay attention to dust prevention and take relevant safety measures when opening the hole.

### 4. Outlet Pipe

(1) The pipe can be led out in the direction of right, rear right, left or rear left. (As show in Fig.3)

(2) When selecting leading out the pipe from left or right, please cut off the corresponding hole on the bottom case. (As show in Fig.4)

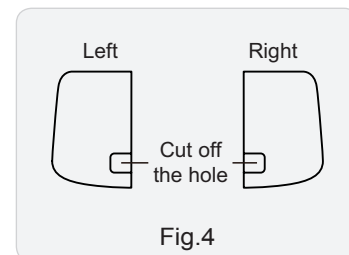
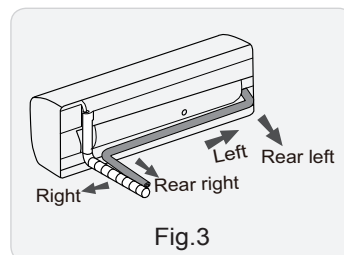

### 5. Connect the Pipe of Indoor Unit

(1) Aim the pipe joint at the corresponding bellmouth. (As show in Fig.5)

(2) Pretightening the union nut with hand.

(3) Adjust the torque force by referring to the following sheet. Place the open-end wrench on the pipe joint and place the torque wrench on the union nut. Tighten the union nut with torque wrench. (As show in Fig.6)

(4) Wrap the indoor pipe and joint of connection pipe with insulating pipe, and then wrap it with tape. (As show in Fig.7)

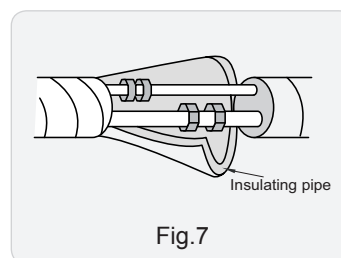
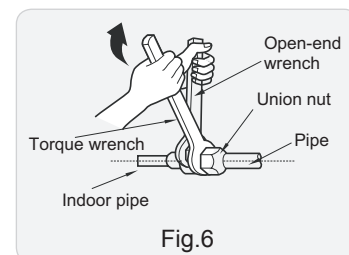
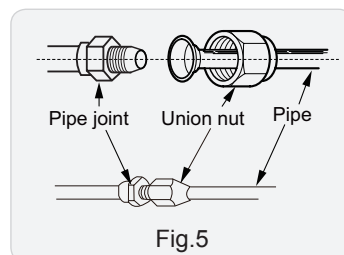

Refer to the following table for wrench moment of force:

Piping size	Tightening torque(N·m)
1/4"	15~20
3/8"	30~40
1/2"	45~55
5/8"	60~65
3/4"	70~75

## 6. Install Drain Hose

(1) Connect the drain hose to the outlet pipe of indoor unit.(As show in Fig.8)

(2) Bind the joint with tape.(As show in Fig.9)

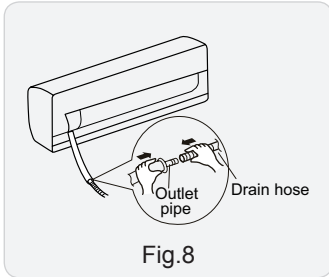

Fig.8

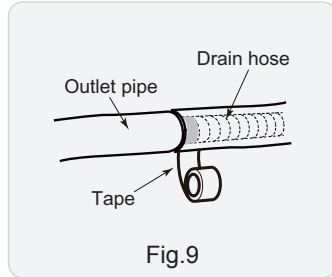

Fig.9

### ⚠ Note:

(1) Add insulating pipe in the indoor drain hose in order to prevent condensation.

(2) The plastic expansion particles are not provided.

(As show in Fig.10)

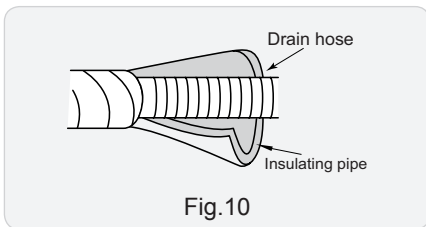

Fig.10

## 7. Connect Wire of Indoor Unit

(1) Open the panel, remove the screw on the wiring cover and then take down the cover.(As show in Fig.11)

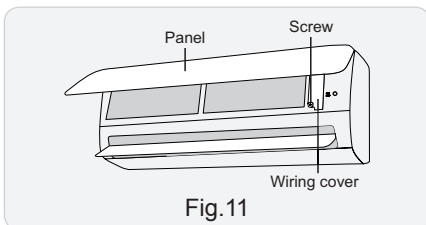

Fig.11

(2) Make the power connection wire go through the cable-cross hole at the back of indoor unit and then pull it out from the front side.(As show in Fig.12)

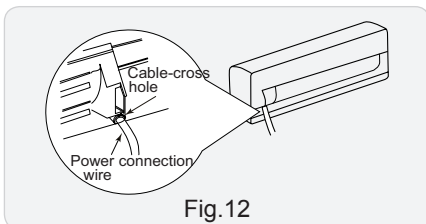

Fig.12

(3) Remove the wire clip; connect the power connection wire signal control wire (only for cooling and heating unit) to the wiring terminal according to the color; tighten the screw and then fix the power connection wire with wire clip.(As show in Fig.13)

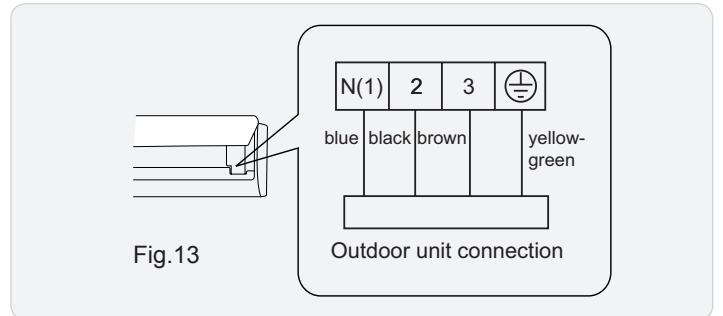

Fig.13

Note: The wiring connect is for reference only, please refer to the actual one.

(4) Put wiring cover back and then tighten the screw.

(5) Close the panel.

### ⚠ Note:

(1) All wires of indoor unit and outdoor unit should be connected by a professional.

(2) If the length of power connection wire is insufficient, please contact the supplier for a new one. Avoid extending the wire by yourself.

(3) For the air conditioner with plug, the plug should be reachable after finishing installation.

(4) For the air conditioner without plug, an air switch must be installed in the line. The air switch should be all-pole parting and the contact parting distance should be more than 3mm.

## 8. Bind up Pipe

(1) Bind up the connection pipe, power cord and drain hose with the band.(As show in Fig.14)

(2) Reserve a certain length of drain hose and power cord for installation when binding them. When binding to a certain degree, separate the indoor power and then separate the drain hose.(As show in Fig.15)

(3) Bind them evenly.

(4) The liquid pipe and gas pipe should be bound separately at the end.

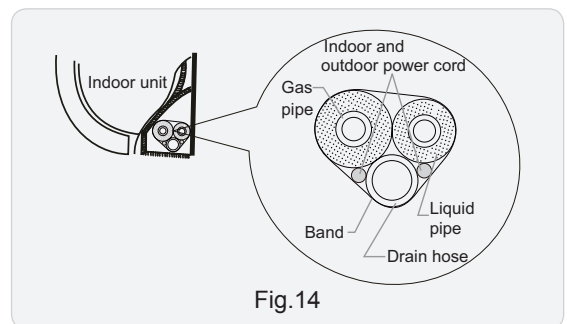

Fig.14

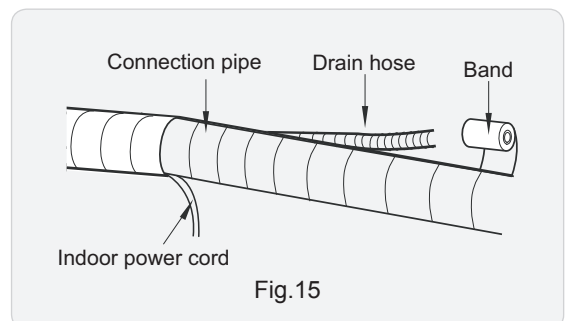

Fig.15

**⚠ Note:**

- (1) The power cord and control wire cant be crossed or winding.
- (2) The drain hose should be bound at the bottom.

**9. Hang the Indoor Unit**

- (1) Put the bound pipes in the wall pipe and then make them pass through the wall hole.
- (2) Hang the indoor unit on the wall-mounting frame.
- (3) Stuff the gap between pipes and wall hole with sealing gum.
- (4) Fix the wall pipe.(As show in Fig.16)
- (5) Check if the indoor unit is installed firmly and closed to the wall.(As show in Fig.17)

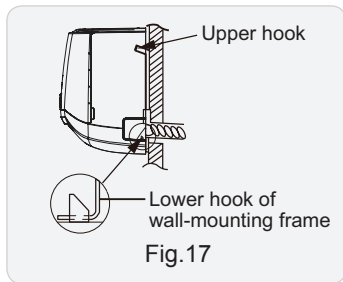
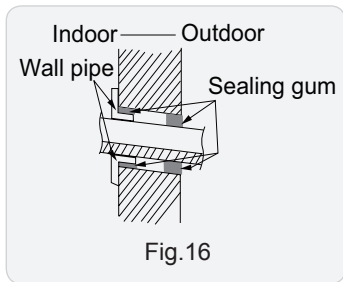

**⚠ Note:**

Do not bend the drain hose too excessively in order to prevent blocking.

**8.6 Installation of Outdoor unit**

**1. Fix the Support of Outdoor Unit(Select it according to the actual installation situation)**

- (1) Select installation location according to the house structure.
- (2) Fix the support of outdoor unit on the selected location with expansion screws.

**⚠ Note:**

- (1) Take sufficient protective measures when installing the outdoor unit.
- (2) Make sure the support can withstand at least four times the unit weight.
- (3) The outdoor unit should be installed at least 3cm above the floor in order to install drain joint.(As show in Fig.18)
- (4) For the unit with cooling capacity of 2300W~5000W, 6 expansion screws are needed; for the unit with cooling capacity of 6000W~8000W, 8 expansion screws are needed; for the unit with cooling capacity of 10000W~16000W, 10 expansion screws are needed.

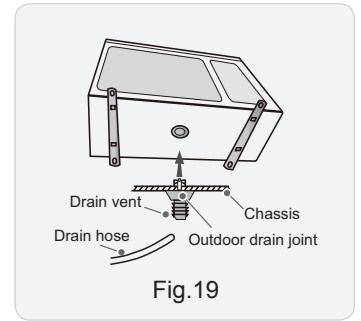
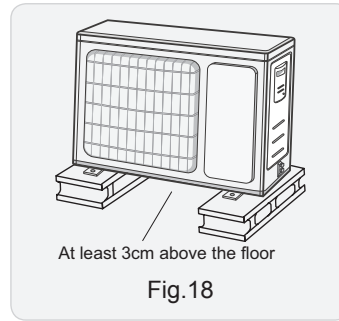

**2. Install Drain Joint(Only for cooling and heating unit)**

- (1) Connect the outdoor drain joint into the hole on the chassis.
  - (2) Connect the drain hose into the drain vent.
- (As show in Fig.19)

**3. Fix Outdoor Unit**

- (1) Place the outdoor unit on the support.
  - (2) Fix the foot holes of outdoor unit with bolts.
- (As show in Fig.20)

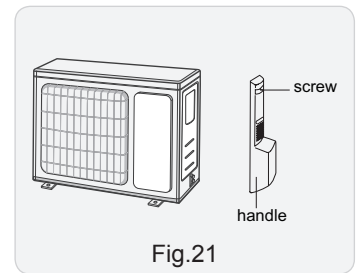
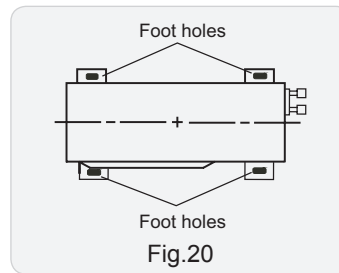

**4. Connect Indoor and Outdoor Pipes**

- (1) Remove the screw on the right handle of outdoor unit and then remove the handle.(As show in Fig.21)

**NOTE:**

- When there're multiple cables passing through it, the cross-hole of handle should be knocked off and eliminate the sharp burrs for avoid damaging the cables.
- Only applicable for some models.

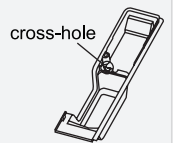

- (2) Remove the screw cap of valve and aim the pipe joint at the bellmouth of pipe.(As show in Fig.22)

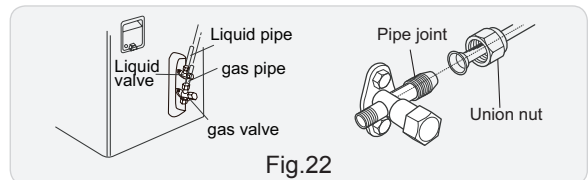

- (3) Pretightening the union nut with hand.
- (4) Tighten the union nut with torque wrench .

Refer to the following table for wrench moment of force :

Piping size	Tightening torque(N·m)
1/4"	15~20
3/8"	30~40
1/2"	45~55
5/8"	60~65
3/4"	70~75

## 5. Connect Outdoor Electric Wire

(1) Remove the wire clip; connect the power connection wire and signal control wire (only for cooling and heating unit) to the wiring terminal according to the color; fix them with screws.(As show in Fig.23)

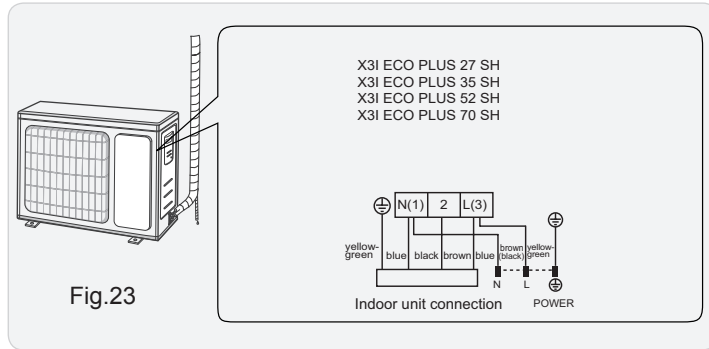

Fig.23

Note: the wiring connect is for reference only, please refer to the actual one.

(2) Fix the power connection wire and signal control wire with wire clip (only for cooling and heating unit).

### ⚠ Note:

(1) After tightening the screw, pull the power cord slightly to check if it is firm.

(2) Never cut the power connection wire to prolong or shorten the distance.

## 6. Neaten the Pipes

(1) The pipes should be placed along the wall, bent reasonably and hidden possibly. Min. semidiameter of bending the pipe is 10cm.

(2) If the outdoor unit is higher than the wall hole, you must set a U-shaped curve in the pipe before pipe goes into the room, in order to prevent rain from getting into the room.(As show in Fig.24)

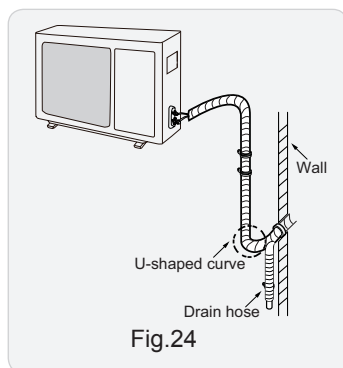

Fig.24

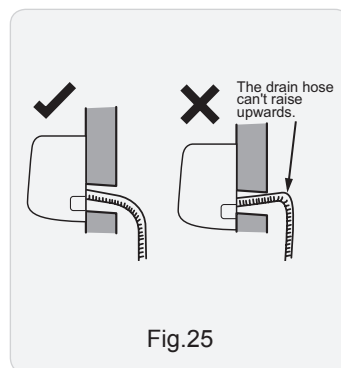

Fig.25

### ⚠ Note:

(1) The through-wall height of drain hose shouldnt be higher than the outlet pipe hole of indoor unit.(As show in Fig.25)

(2) Slant the drain hose slightly downwards. The drain hose cant be curved, raised and fluctuant, etc.(As show in Fig.26)

(3) The water outlet cant be placed in water in order to drain smoothly.(As show in Fig.27)

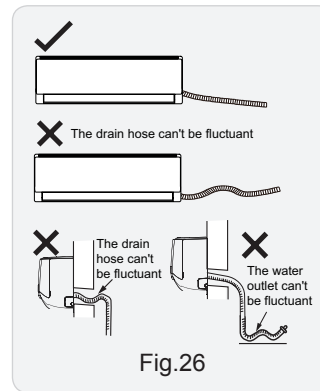

Fig.26

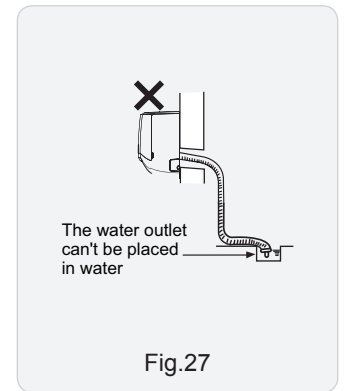

Fig.27

## 8.7 Vacuum Pumping and Leak Detection

### 1. Use Vacuum Pump

(1) Remove the valve caps on the liquid valve and gas valve and the nut of refrigerant charging vent.

(2) Connect the charging hose of piezometer to the refrigerant charging vent of gas valve and then connect the other charging hose to the vacuum pump.

(3) Open the piezometer completely and operate for 10-15min to check if the pressure of piezometer remains in -0.1MPa.

(4) Close the vacuum pump and maintain this status for 1-2min to check if the pressure of piezometer remains in -0.1MPa. If the pressure decreases, there may be leakage.

(5) Remove the piezometer, open the valve core of liquid valve and gas valve completely with inner hexagon spanner.

(6) Tighten the screw caps of valves and refrigerant charging vent.(As show in Fig.28)

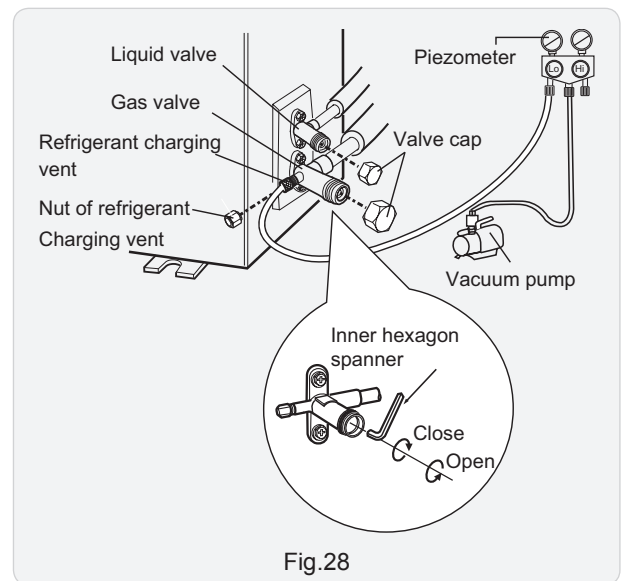

Fig.28

### 2. Leakage Detection

(1) With leakage detector:

Check if there is leakage with leakage detector.

(2) With soap water:

If leakage detector is not available, please use soap water for leakage detection. Apply soap water at the suspected position and keep the soap water for more than 3min. If there are air bubbles coming out of this position, there's a leakage.

## 8.8 Check after Installation and Test operation

### 1. Check after Installation

Check according to the following requirement after finishing installation.

NO.	Items to be checked	Possible malfunction
1	Has the unit been installed firmly?	The unit may drop, shake or emit noise.
2	Have you done the refrigerant leakage test?	It may cause insufficient cooling (heating) capacity.
3	Is heat insulation of pipeline sufficient?	It may cause condensation and water dripping.
4	Is water drained well?	It may cause condensation and water dripping.
5	Is the voltage of power supply according to the voltage marked on the nameplate?	It may cause malfunction or damage the parts.
6	Is electric wiring and pipeline installed correctly?	It may cause malfunction or damage the parts.
7	Is the unit grounded securely?	It may cause electric leakage.
8	Does the power cord follow the specification?	It may cause malfunction or damage the parts.
9	Is there any obstruction in air inlet and air outlet?	It may cause insufficient cooling (heating) capacity.
10	The dust and sundries caused during installation are removed?	It may cause malfunction or damaging the parts.
11	The gas valve and liquid valve of connection pipe are open completely?	It may cause insufficient cooling (heating) capacity.
12	Is the inlet and outlet of piping hole been covered?	It may cause insufficient cooling(heating) capacity or waster eletricity.

### 2. Test Operation

(1) Preparation of test operation

- The client approves the air conditioner installation.
- Specify the important notes for air conditioner to the client.

(2) Method of test operation

- Put through the power, press ON/OFF button on the remote controller to start operation.
- Press MODE button to select AUTO, COOL, DRY, FAN and HEAT to check whether the operation is normal or not.
- If the ambient temperature is lower than 16 °C , the air conditioner cant start cooling.

# 9. Maintenance

## 9.1 Error Code List

Malfunction Name	Display Method of Indoor Unit (Error Code)	A/C Status	Possible Causes(For specific maintenance method, please refer to the following procedure of troubleshooting)
High pressure protection of system	E1	During cooling and drying operation, except indoor fan operates, all loads stop operation. During heating operation, the complete unit stops.	Possible reasons: 1. Refrigerant was superabundant; 2. Poor heat exchange (including filth blockage of heat exchanger and bad radiating environment ); Ambient temperature is too high.
Antifreezing protection for evaporator	E2		Not the error code. It's the status code for the operation.
System block or refrigerant leakage	E3	The Dual-8 Code Display will show E3 until the low pressure switch stop operation.	1.Low-pressure protection 2.Low-pressure protection of system 3.Low-pressure protection of compressor
High discharge temperature protection of compressor	E4	During cooling and drying operation, compressor and outdoor fan stop while indoor fan operates. During heating operation, all loads stop.	Please refer to the malfunction analysis (discharge protection, overload).
Overcurrent protection	E5	During cooling and drying operation, compressor and outdoor fan stop while indoor fan operates. During heating operation, all loads stop.	1. Supply voltage is unstable; 2. Supply voltage is too low and load is too high; 3. Evaporator is dirty.
Communication Malfunction	E6	During cooling operation, compressor stops while indoor fan motor operates. During heating operation, the complete unit stops.	Refer to the corresponding malfunction analysis.
High temperature resistant protection	E8	During cooling operation: compressor will stop while indoor fan will operate. During heating operation, the complete unit stops.	Refer to the malfunction analysis (overload, high temperature resistant).
EEPROM malfunction	EE	During cooling and drying operation, compressor will stop while indoor fan will operate; During heating operation, the complete unit will stop	Replace outdoor control panel AP1
Limit/decrease frequency due to high temperature of module	EU	All loads operate normally, while operation frequency for compressor is decreased	Discharging after the complete unit is de-energized for 20mins, check whether the thermal grease on IPM Module of outdoor control panel AP1 is sufficient and whether the radiator is inserted tightly. If its no use, please replace control panel AP1.
Malfunction protection of jumper cap	C5	Wireless remote receiver and button are effective, but can not dispose the related command	1. No jumper cap insert on mainboard. 2. Incorrect insert of jumper cap. 3. Jumper cap damaged. 4. Abnormal detecting circuit of mainboard.
Leak/low gas refrigerant	F0	In cooling and dehumidification : with the exception of the indoor unit fan motor, everything else doesn't work. In heating, the unit stops completely.	Low refrigerant gas quantity or gas leak
Indoor ambient temperature sensor is open/short circuited	F1	During cooling and drying operation, indoor unit operates while other loads will stop; during heating operation, the complete unit will stop operation.	1. Loosening or bad contact of indoor ambient temp. sensor and mainboard terminal. 2. Components in mainboard fell down leads short circuit. 3. Indoor ambient temp. sensor damaged.(check with sensor resistance value chart) 4. Mainboard damaged.
Indoor evaporator temperature sensor is open/short circuited	F2	AC stops operation once reaches the setting temperature. Cooling, drying: internal fan motor stops operation while other loads stop operation; heating: AC stop operation	1. Loosening or bad contact of Indoor evaporator temp. sensor and mainboard terminal. 2. Components on the mainboard fall down leads short circuit. 3. Indoor evaporator temp. sensor damaged.(check temp. sensor value chart for testing) 4. Mainboard damaged.

Outdoor ambient temperature sensor is open/short circuited	F3	During cooling and drying operating, compressor stops while indoor fan operates; During heating operation, the complete unit will stop operation	Outdoor temperature sensor hasn't been connected well or is damaged. Please check it by referring to the resistance table for temperature sensor)
Outdoor condenser temperature sensor is open/short circuited	F4	During cooling and drying operation, compressor stops while indoor fan will operate; During heating operation, the complete unit will stop operation.	Outdoor temperature sensor hasn't been connected well or is damaged. Please check it by referring to the resistance table for temperature sensor)
Outdoor discharge temperature sensor is open/short circuited	F5	During cooling and drying operation, compressor will stop after operating for about 3 mins, while indoor fan will operate; During heating operation, the complete unit will stop after operating for about 3 mins.	1. Outdoor temperature sensor hasn't been connected well or is damaged. Please check it by referring to the resistance table for temperature sensor) 2. The head of temperature sensor hasn't been inserted into the copper tube
Limit/decrease frequency due to overload	F6	All loads operate normally, while operation frequency for compressor is decreased	Refer to the malfunction analysis (overload, high temperature resistant)
Decrease frequency due to overcurrent	F8	All loads operate normally, while operation frequency for compressor is decreased	The input supply voltage is too low; System pressure is too high and overload
Decrease frequency due to high air discharge	F9	All loads operate normally, while operation frequency for compressor is decreased	Overload or temperature is too high; Refrigerant is insufficient; Malfunction of electric expansion valve (EKV)
Limit/decrease frequency due to antifreezing	FH	All loads operate normally, while operation frequency for compressor is decreased	Poor air-return in indoor unit or fan speed is too low
Voltage for DC bus-bar is too high	PH	During cooling and drying operation, compressor will stop while indoor fan will operate; During heating operation, the complete unit will stop operation.	1. Measure the voltage of position L and N on wiring board (XT), if the voltage is higher than 265VAC, turn on the unit after the supply voltage is increased to the normal range. 2. If the AC input is normal, measure the voltage of electrolytic capacitor C on control panel (AP1), if its normal, there's malfunction for the circuit, please replace the control panel (AP1)
Voltage of DC bus-bar is too low	PL	During cooling and drying operation, compressor will stop while indoor fan will operate; During heating operation, the complete unit will stop	1. Measure the voltage of position L and N on wiring board (XT), if the voltage is higher than 150VAC, turn on the unit after the supply voltage is increased to the normal range. 2. If the AC input is normal, measure the voltage of electrolytic capacitor C on control panel (AP1), if its normal, there's malfunction for the circuit, please replace the control panel (AP1)
Compressor Min frequency in test state	P0		Showing during min. cooling or min. heating test
Compressor rated frequency in test state	P1		Showing during nominal cooling or nominal heating test
Compressor maximum frequency in test state	P2		Showing during max. cooling or max. heating test
Compressor intermediate frequency in test state	P3		Showing during middle cooling or middle heating test
Overcurrent protection of phase current for compressor	P5	During cooling and drying operation, compressor will stop while indoor fan will operate; During heating operation, the complete unit will stop operation.	Refer to the malfunction analysis (IPM protection, loss of synchronism protection and overcurrent protection of phase current for compressor).
Charging malfunction of capacitor	PU	During cooling and drying operation, compressor will stop while indoor fan will operate; During heating operation, the complete unit will stop	Refer to the part three—charging malfunction analysis of capacitor



Malfunction of module temperature sensor circuit	P7	During cooling and drying operation, compressor will stop while indoor fan will operate; During heating operation, the complete unit will stop	Replace outdoor control panel AP1
Module high temperature protection	P8	During cooling operation, compressor will stop while indoor fan will operate; During heating operation, the complete unit will stop	After the complete unit is de-energized for 20mins, check whether the thermal grease on IPM Module of outdoor control panel AP1 is sufficient and whether the radiator is inserted tightly. If its no use, please replace control panel AP1.
Overload protection for compressor	H3	During cooling and drying operation, compressor will stop while indoor fan will operate; During heating operation, the complete unit will stop operation.	1. Wiring terminal OVC-COMP is loosened. In normal state, the resistance for this terminal should be less than 1ohm. 2.Refer to the malfunction analysis ( discharge protection, overload)
IPM protection	H5	During cooling and drying operation, compressor will stop while indoor fan will operate; During heating operation, the complete unit will stop operation.	Refer to the malfunction analysis (IPM protection, loss of synchronism protection and overcurrent protection of phase current for compressor.
Malfunction of zero-cross detection circuit	U8	The complete unit stops	1.Power supply is abnormal; 2.Detection circuit of indoor control mainboard is abnormal.
Internal motor (fan motor) do not operate	H6	Internal fan motor, external fan motor, compressor and electric heater stop operation,guide louver stops at present location.	1. Bad contact of DC motor feedback terminal. 2. Bad contact of DC motor control end. 3. Fan motor is stalling. 4. Motor malfunction. 5. Malfunction of mainboard revdetecting circuit.
Desynchro-nizing of compressor	H7	During cooling and drying operation, compressor will stop while indoor fan will operate; During heating operation, the complete unit will stop operation.	Refer to the malfunction analysis (IPM protection, loss of synchronism protection and overcurrent protection of phase current for compressor.
PFC protection	HC	During cooling and drying operation, compressor will stop while indoor fan will operate; During heating operation, the complete unit will stop operation.	Refer to the malfunction analysis
Outdoor DC fan motor malfunction	L3	Outdoor DC fan motor malfunction lead to compressor stop operation,	DC fan motor malfunction or system blocked or the connector loosed
power protection	L9	compressor stop operation and Outdoor fan motor will stop 30s latter , 3 minutes latter fan motor and compressor will restart	To protect the electronical components when detect high power
Indoor unit and outdoor unit doesnt match	LP	compressor and Outdoor fan motor cant work	Indoor unit and outdoor unit doesnt match
Failure start-up	LC	During cooling and drying operation, compressor will stop while indoor fan will operate; During heating operation, the complete unit will stop operation.	Refer to the malfunction analysis
Defrosting	Heating indicator off for 0.5s and then blinks for 10s	Defrosting will occur in heating mode. Compressor will operate while indoor fan will stop operation.	Not the error code. It's the status code for the operation
The four-way valve is abnormal	U7	If this malfunction occurs during heating operation, the complete unit will stop operation.	1.Supply voltage is lower than AC175V; 2.Wiring terminal 4V is loosened or broken; 3.4V is damaged, please replace 4V.

Malfunction of phase current detection circuit for compressor	U1	During cooling and drying operation, compressor will stop while indoor fan will operate; During heating operation, the complete unit will stop	Replace outdoor control panel AP1
Malfunction of voltage dropping for DC busbar	U3	During cooling and drying operation, compressor will stop while indoor fan will operate; During heating operation, the complete unit will stop	Supply voltage is unstable
Malfunction of complete units current detection	U5	During cooling and drying operation, the compressor will stop while indoor fan will operate; During heating operating, the complete unit will stop operation.	Theres circuit malfunction on outdoor units control panel AP1, please replace the outdoor units control panel AP1.
Cold air prevention protection	E9		Not the error code. It's the status code for the operation.
Refrigerant recovery mode	Fo		Refrigerant recovery. The Serviceman operates it for maintenance.
Malfunction of detecting plate(WIFI)	JF	Loads operate normally, while the unit can't be normally controlled by APP.	1.Main board of indoor unit is damaged; 2.Detection board is damaged; 3.The connection between indoor unit and detection board is not good;
Undefined outdoor unit error	oE	Cool: compressor and outdoor fan stops operation, while indoor fan operates; Heat: compressor, outdoor fan and indoor fan stop operation.	1. Outdoor ambient temperature exceeds the operation range of unit (eg: less than- 20°C or more than 60°C for cooling; more than 30°C for heating); 2. Failure startup of compressor? 3. Are wires of compressor not connected tightly? 4. Is compressor damaged? 5. Is main board damaged?

## Analysis or processing of some of the malfunction display:

### 1. Compressor discharge protection

Possible causes: shortage of refrigerant; blockage of air filter; poor ventilation or air flow short pass for condenser; the system has noncondensing gas (such as air, water etc.); blockage of capillary assy (including filter); leakage inside four-way valve causes incorrect operation; malfunction of compressor; malfunction of protection relay; malfunction of discharge sensor; outdoor temperature too high.

Processing method: refer to the malfunction analysis in the above section.

### 2. Low voltage overcurrent protection

Possible cause: Sudden drop of supply voltage.

### 3.Communication malfunction

Processing method: Check if communication signal cable is connected reliably.

### 4. Sensor open or short circuit

Processing method: Check whether sensor is normal, connected with the corre sponding position on the controller and if damage of lead wire is found.

### 5. Compressor over load protection

Possible causes: insufficient or too much refrigerant; blockage of capillary and increase of suction temp.; improper running of compressor, burning in or stuck of bearing, damage of discharge valve; malfunction of protector.

Processing method: adjust refrigerant amount; replace the capillary; replace the compressor; use universal meter to check if the contactor of compress or is fine when it is not overheated, if not replace the protector.

### 6. System malfunction

i.e.overload protection.When tube temperature(Check the temperature of outdoor heat exchanger when cooling and check the temperatur e of indoor heat exchanger when heating) is too high, protection will be activated.

Possible causes: Outdoor temperature is too high when cooling; insufficient outdoor air circulation; refrigerant flow malfunction.

please refer to the malfunction analysis in the previous section for handling method .

### 7. IPM module protection

Processing method:Once the module malfunction happens,if it persists for a long time and can not be selfcanceled, cut off the power and turn off the unit,and then re-energize the unit again after about 10 min.After repeating the procedure for sever times, if the malfunction still exists,replace the module.

If malfunction occurs, corresponding code will display and the unit will resume normal until protection or malfunction disappears.

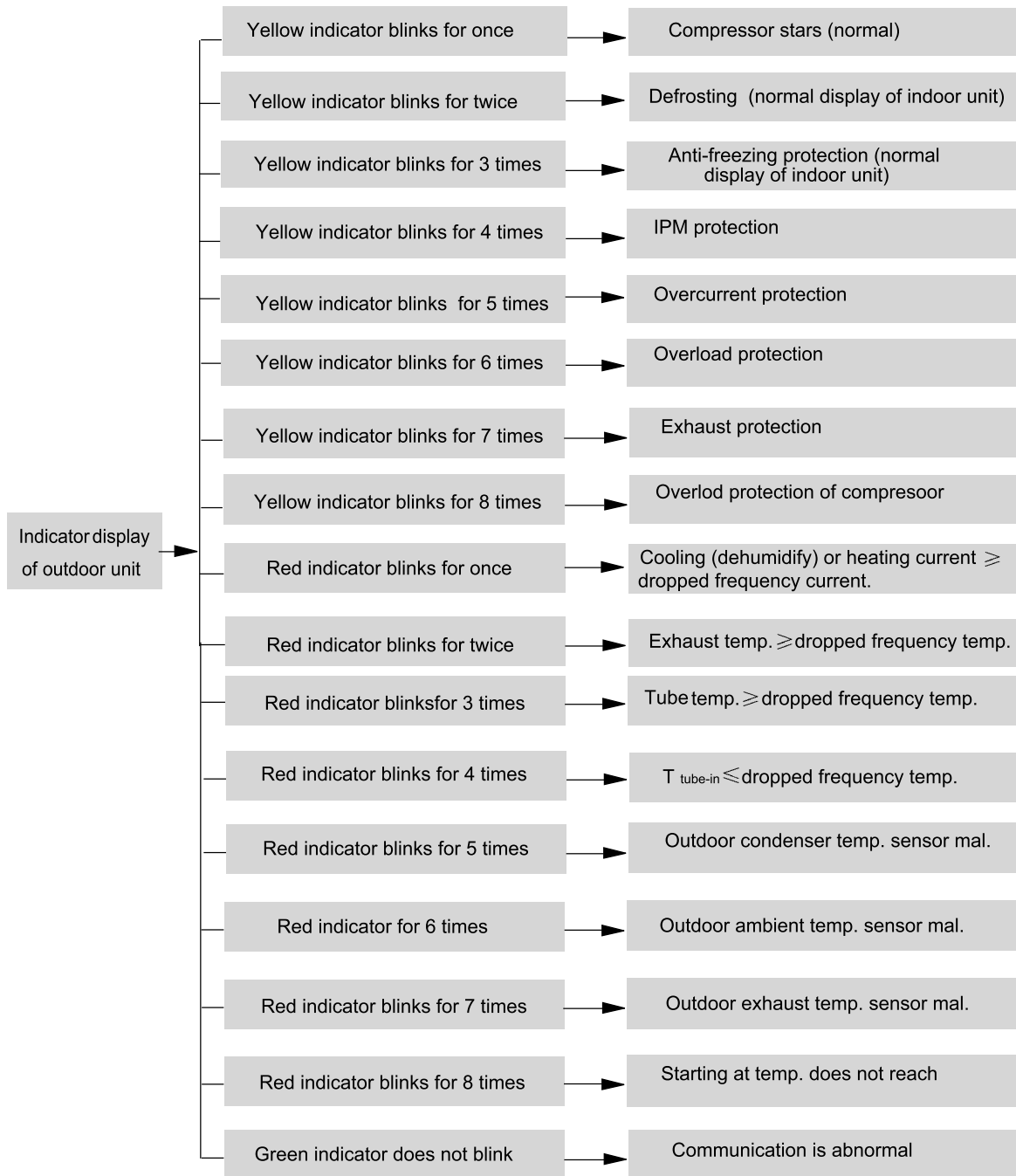

## 9.2 Procedure of Troubleshooting

### ●Indoor unit:

#### 1. Malfunction of Temperature Sensor F1, F2

Main detection points:

- Is the wiring terminal between the temperature sensor and the controller loosened or poorly contacted?
- Is there short circuit due to trip-over of the parts?
- Is the temperature sensor broken?
- Is mainboard broken?

Malfunction diagnosis process:

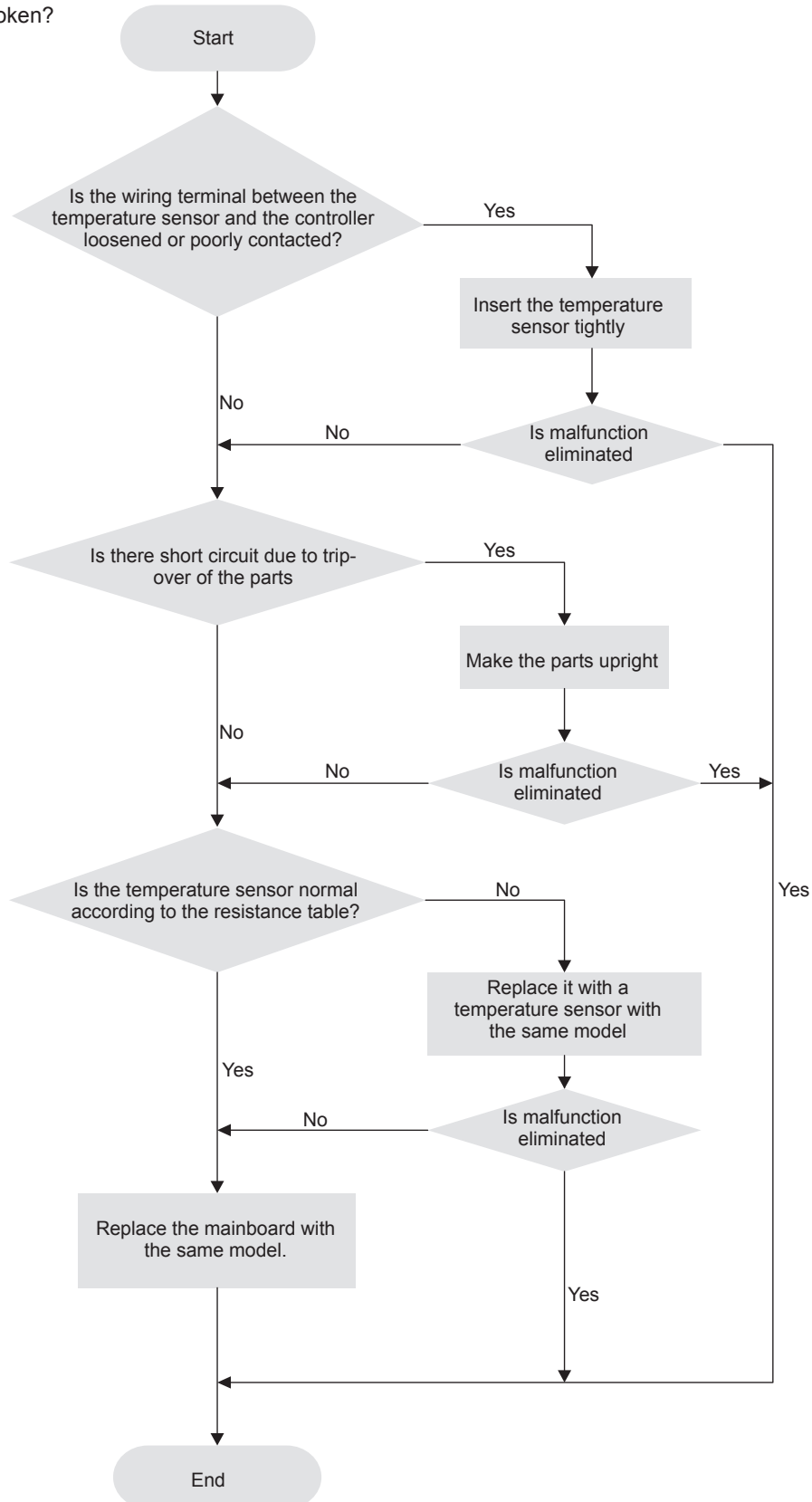

## 2. Malfunction of Blocked Protection of IDU Fan Motor H6

Main detection points:

- SmoothlyIs the control terminal of PG motor connected tightly?
- SmoothlyIs the feedback interface of PG motor connected tightly?
- The fan motor can't operate?
- The motor is broken?
- Detectioncircuit of the mainboard is defined abnormal?

Malfunction diagnosis process:

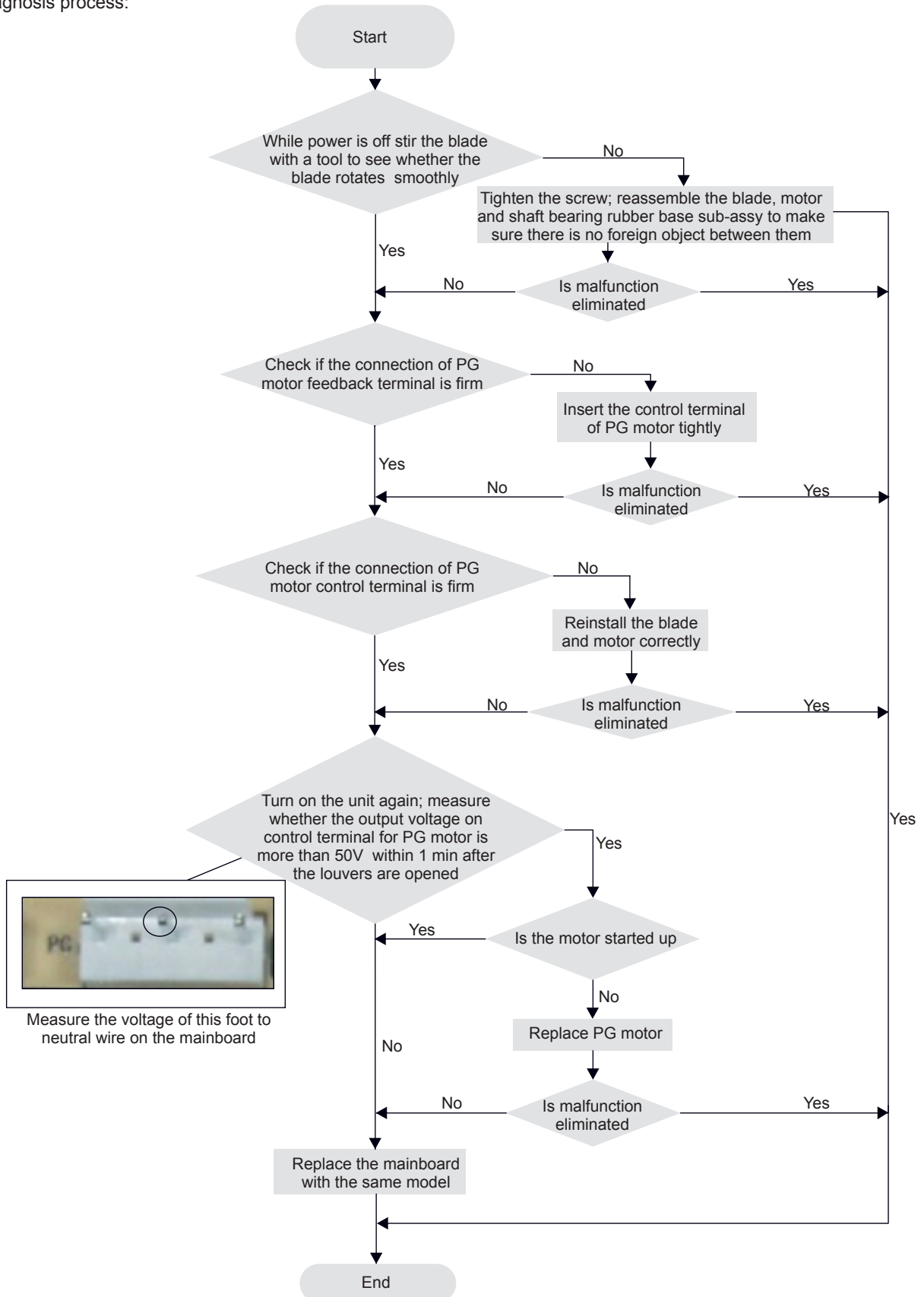

### 3. Malfunction of Protection of Jumper Cap C5

Main detection points:

- Is there jumper cap on the mainboard?
- Is the jumper cap inserted correctly and tightly?
- The jumper is broken?
- The motor is broken?
- Detection circuit of the mainboard is defined abnormal?

Malfunction diagnosis process:

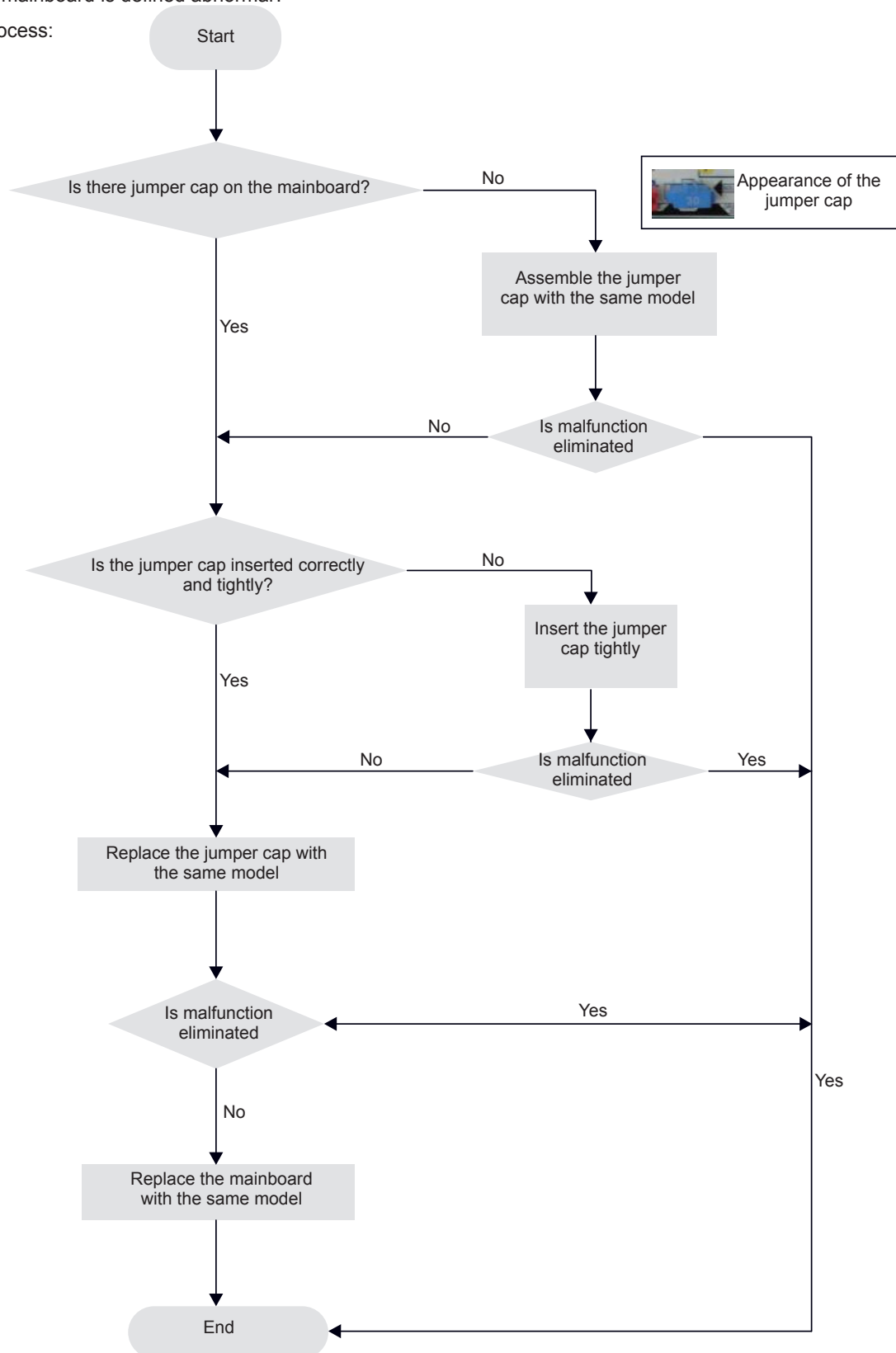

#### 4. Malfunction of Zero-crossing Inspection Circuit Malfunction of the IDU Fan Motor U8

Main detection points:

- Instant energization after de-energization while the capacitor discharges slowly?
- The zero-cross detection circuit of the mainboard is defined abnormal?

Malfunction diagnosis process:

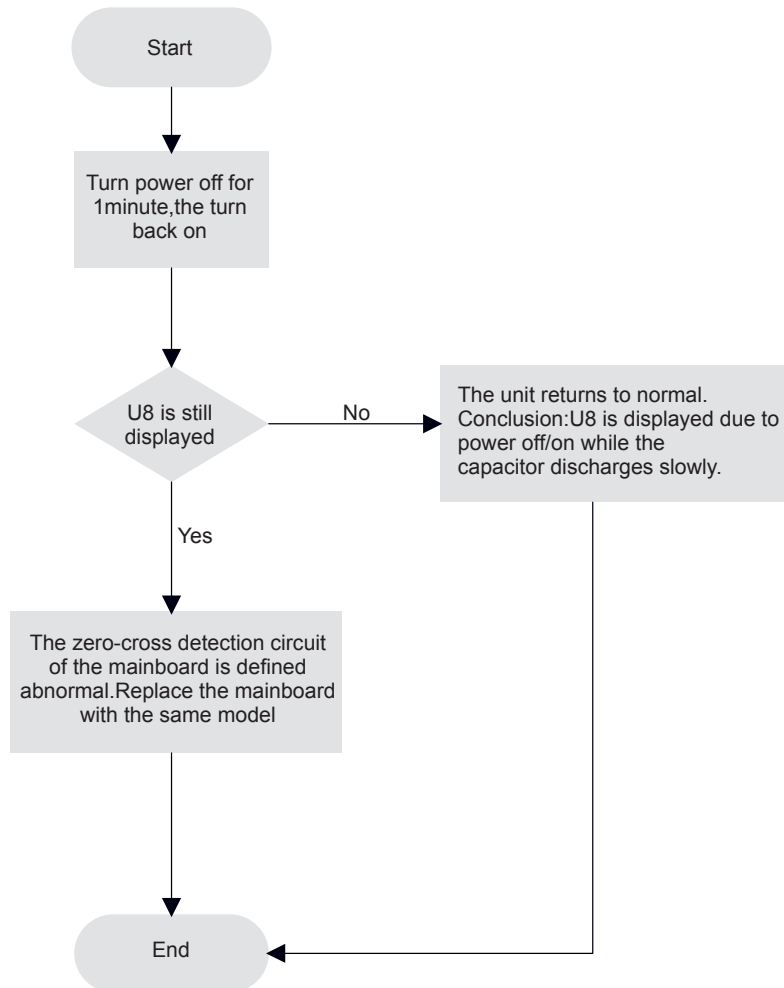

## 5. High Temperature and Overload Protection (AP1 below means control board of outdoor unit) E8

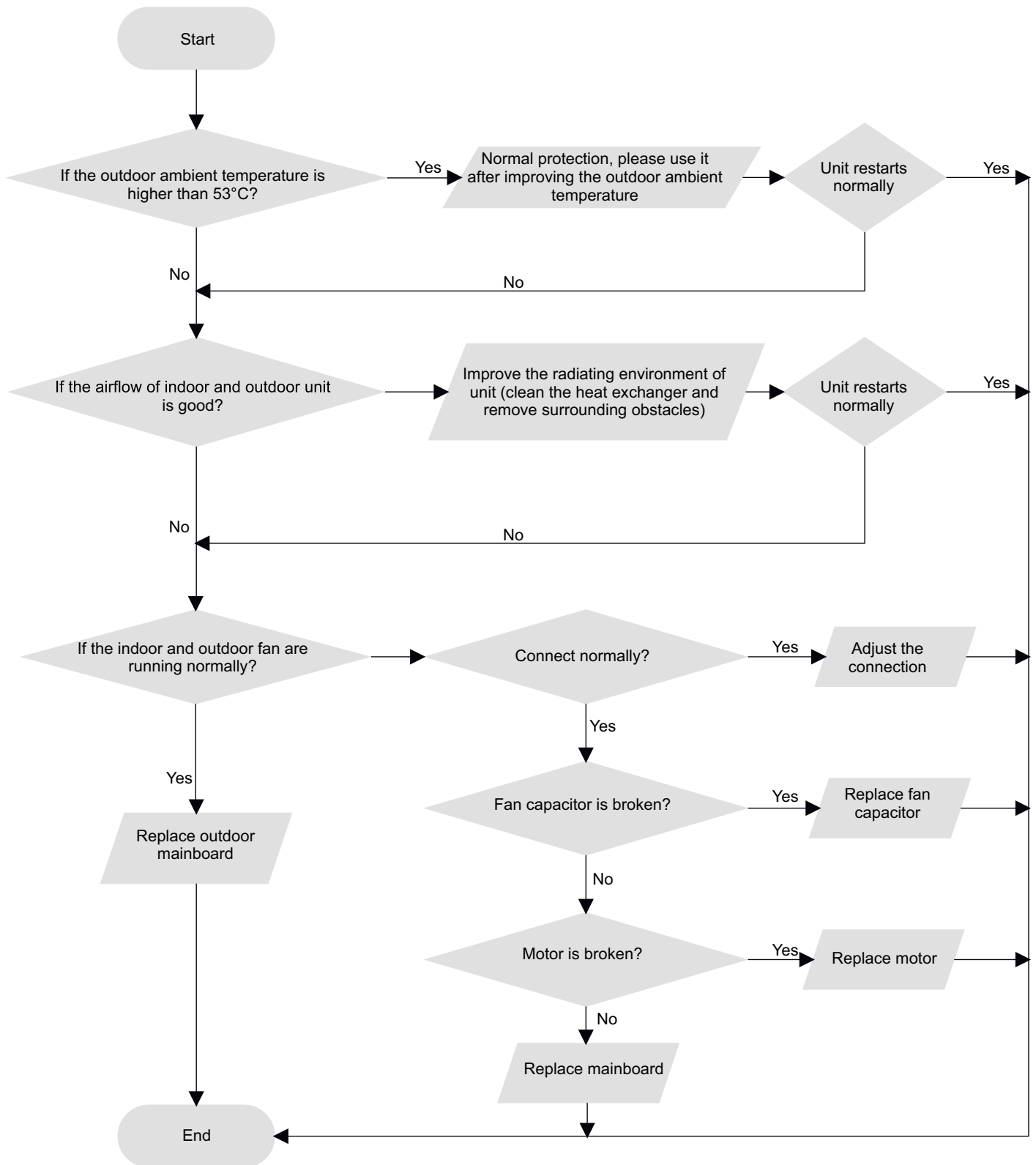



## 6. Malfunction of detecting plate(WIFI) JF

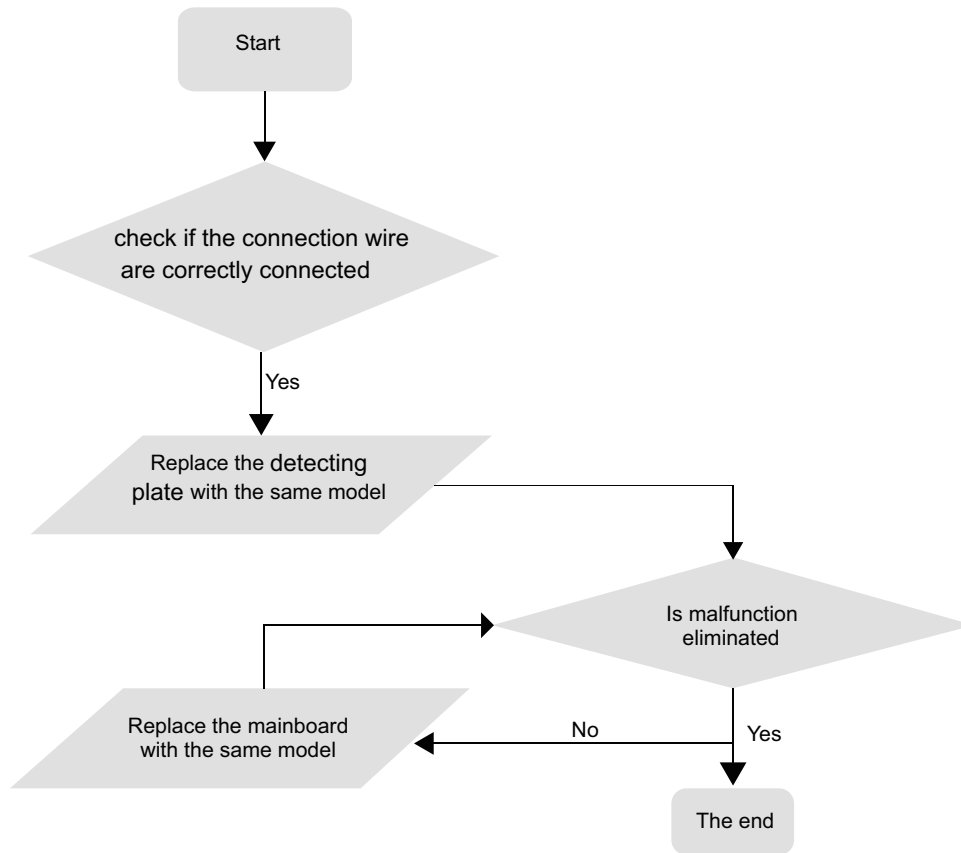

●Outdoor unit:

1.Capacity charging malfunction (outdoor unit malfunction) (AP1 below is control board of outdoor unit)

Main detection point:

- Detect if the voltage of L and N terminal of wiring board is between 210AC-240AC by alternating voltage meter;
- Is reactor (L) well connected? Is connection wire loosened or pull-out? Is reactor (L) damaged?

Malfunction diagnosis process:

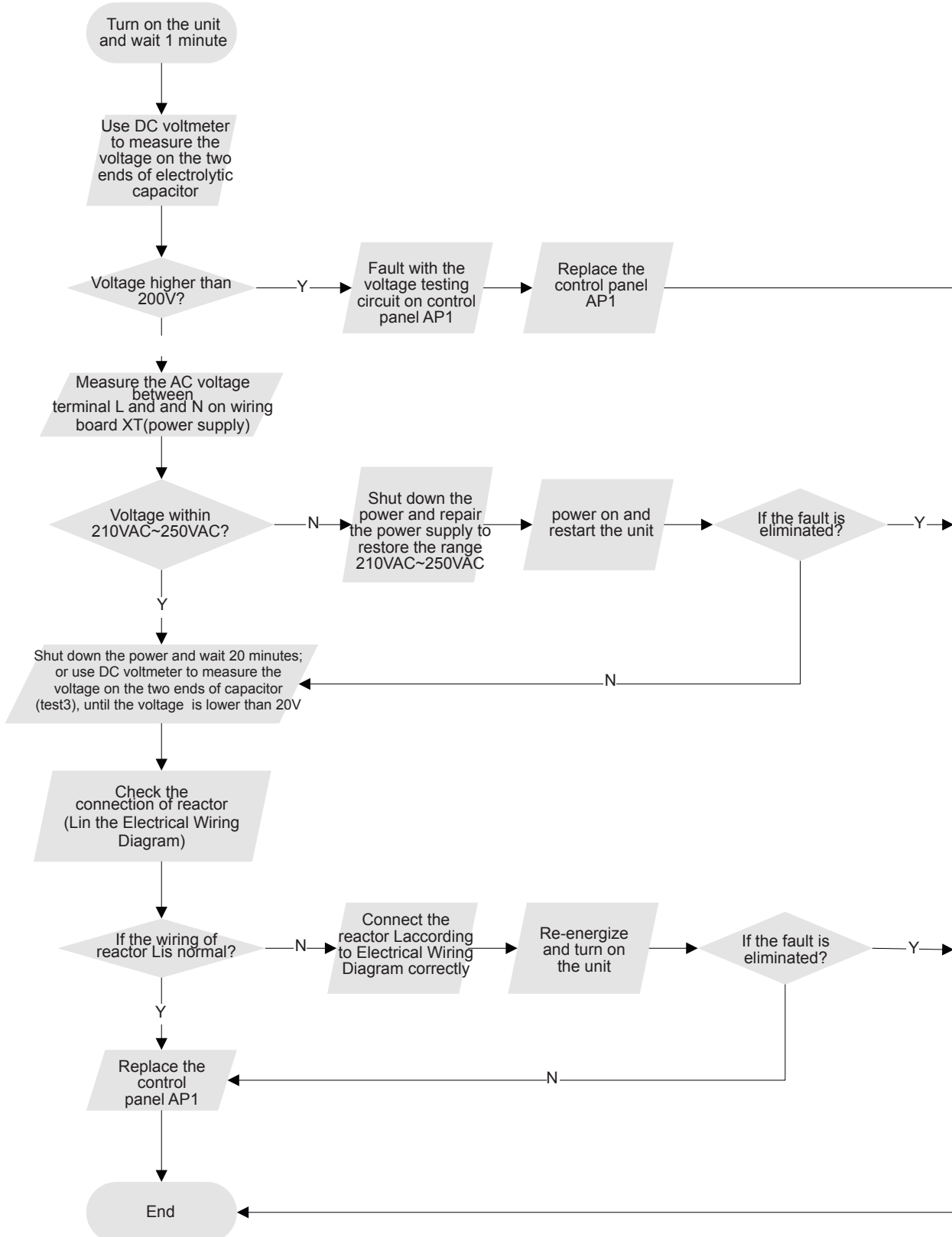

## 2.Diagnosis for anti-high temperature, overload protection (AP1 below is control board of outdoor unit)

Main detection point:

- If the outdoor ambient temperature is in normal range;
- If the indoor and outdoor fan is running normal;
- If the radiating environment of indoor and outdoor unit is well.

Malfunction diagnosis process:

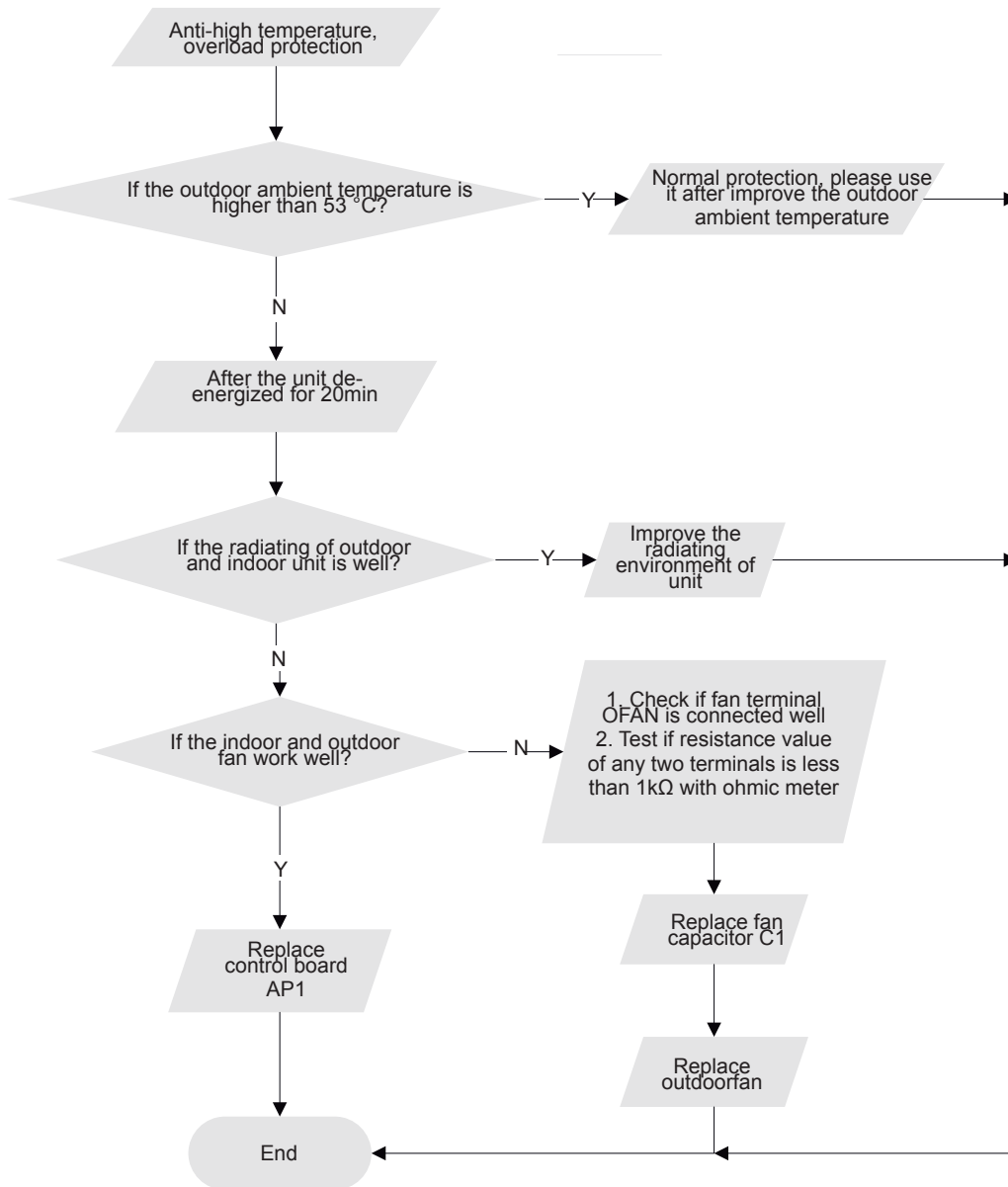

**3. IPM protection, phase current overcurrent (the control board as below indicates the control board of outdoor unit) H5/P5**

Mainly detect:

- (1) Compressor COMP terminal (2) voltage of power supply (3) compressor (4) Refrigerant-charging volume (5) air outlet and air inlet of outdoor/indoor unit

Troubleshooting:

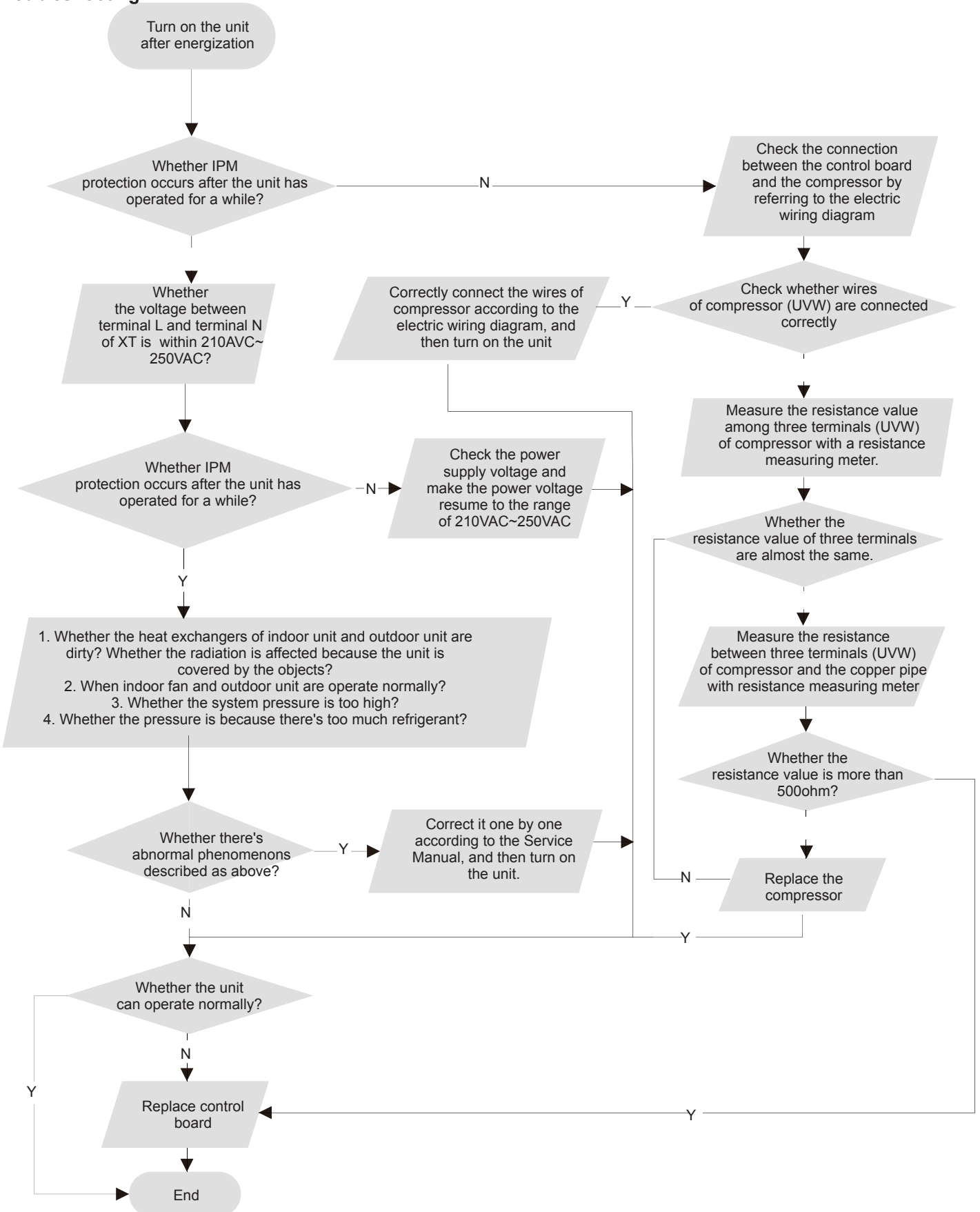

#### 4. Start-up failure (following AP1 for outdoor unit control board)

Mainly detect:

- Whether the compressor wiring is connected correct?
- Is compressor broken?
- Is time for compressor stopping enough?

Fault diagnosis process:

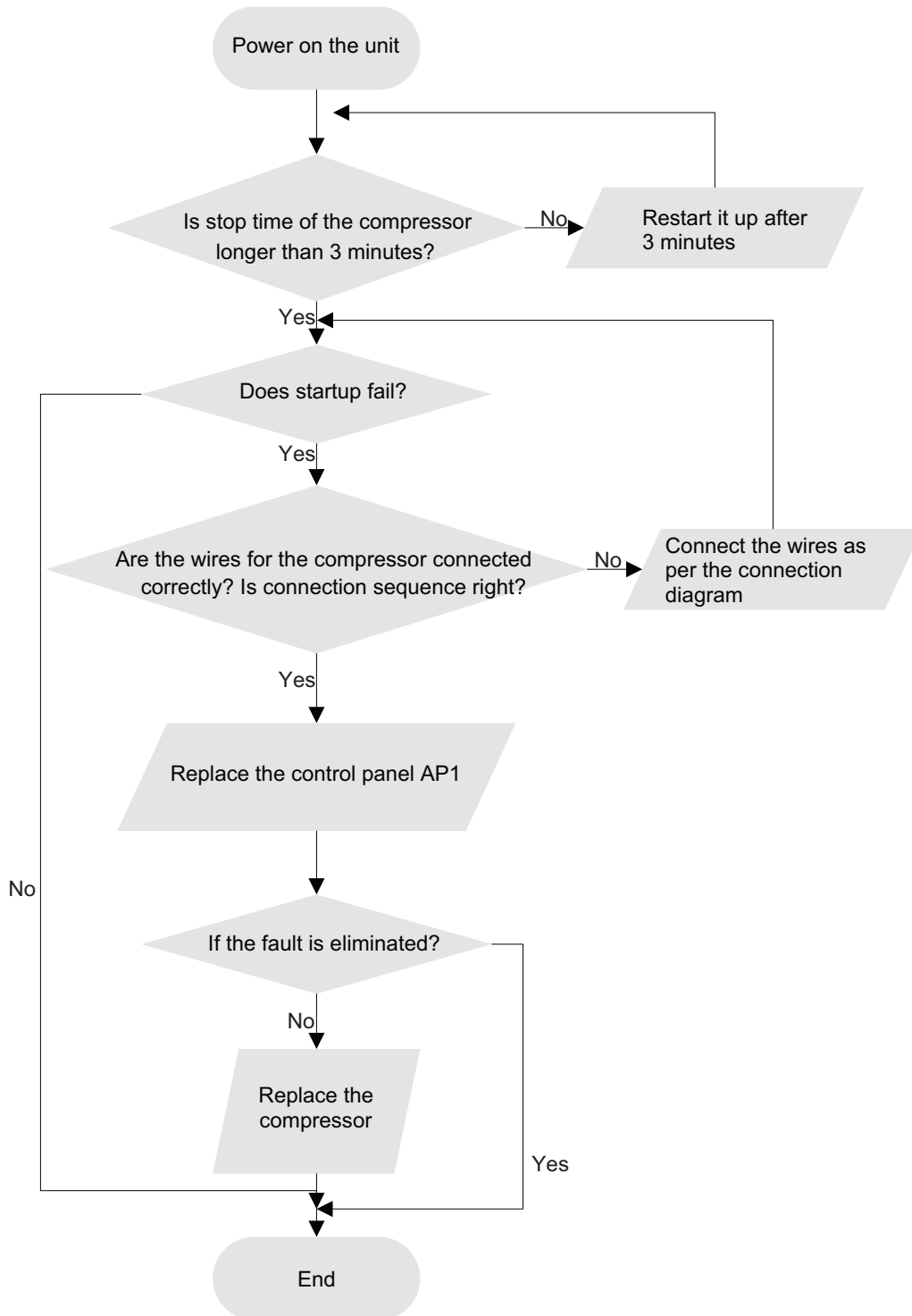

## 5. Out of step diagnosis for the compressor (AP1 hereinafter refers to the control board of the outdoor unit)

Mainly detect:

- Is the system pressure too high?
- Is the input voltage too low?

Fault diagnosis process:

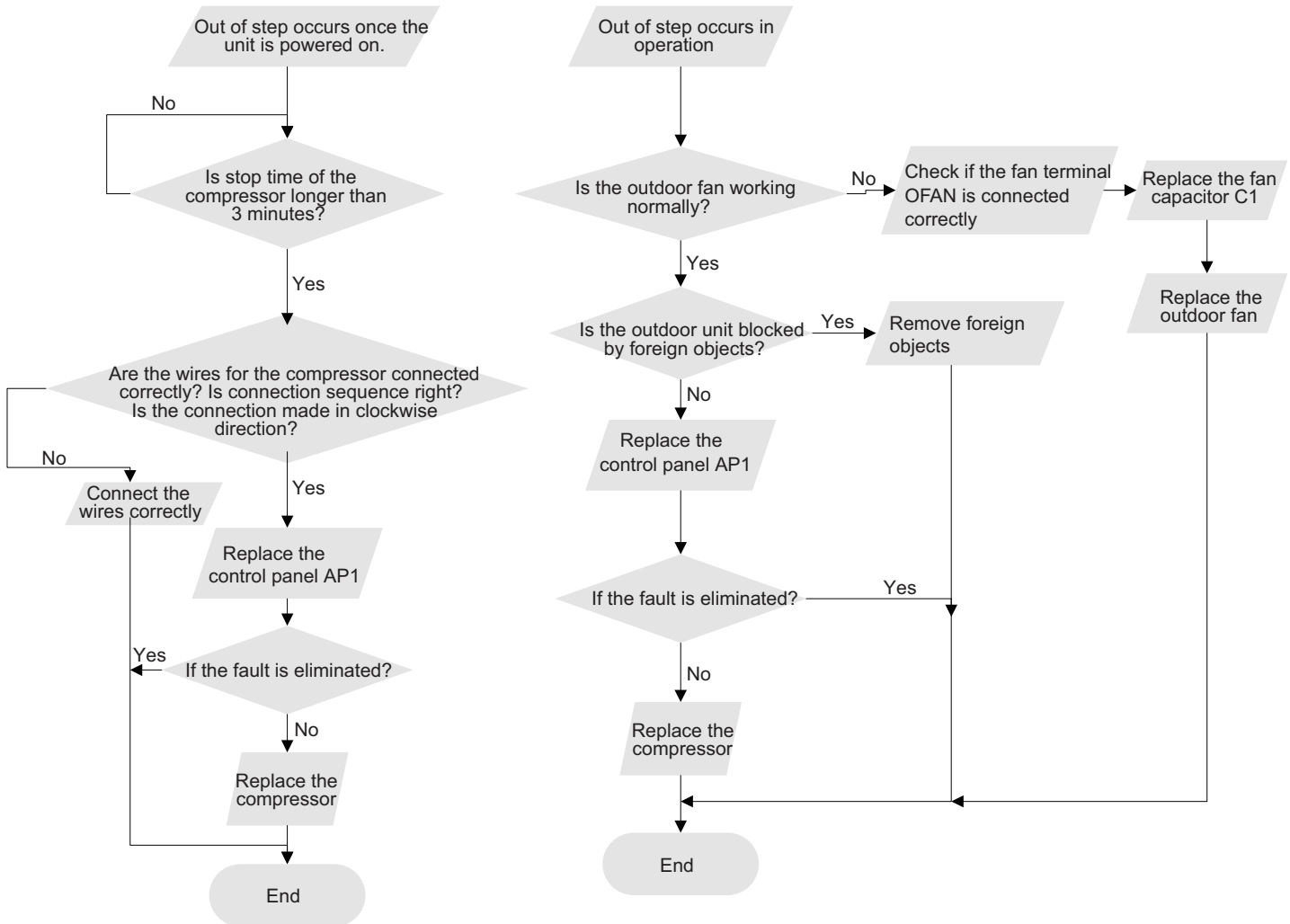

## 6. Overload and air exhaust malfunction diagnosis (following AP1 for outdoor unit control board)

Mainly detect:

- Is the PMV connected well or not? Is PMV damaged?
- Is refrigerant leaked?

Fault diagnosis process:

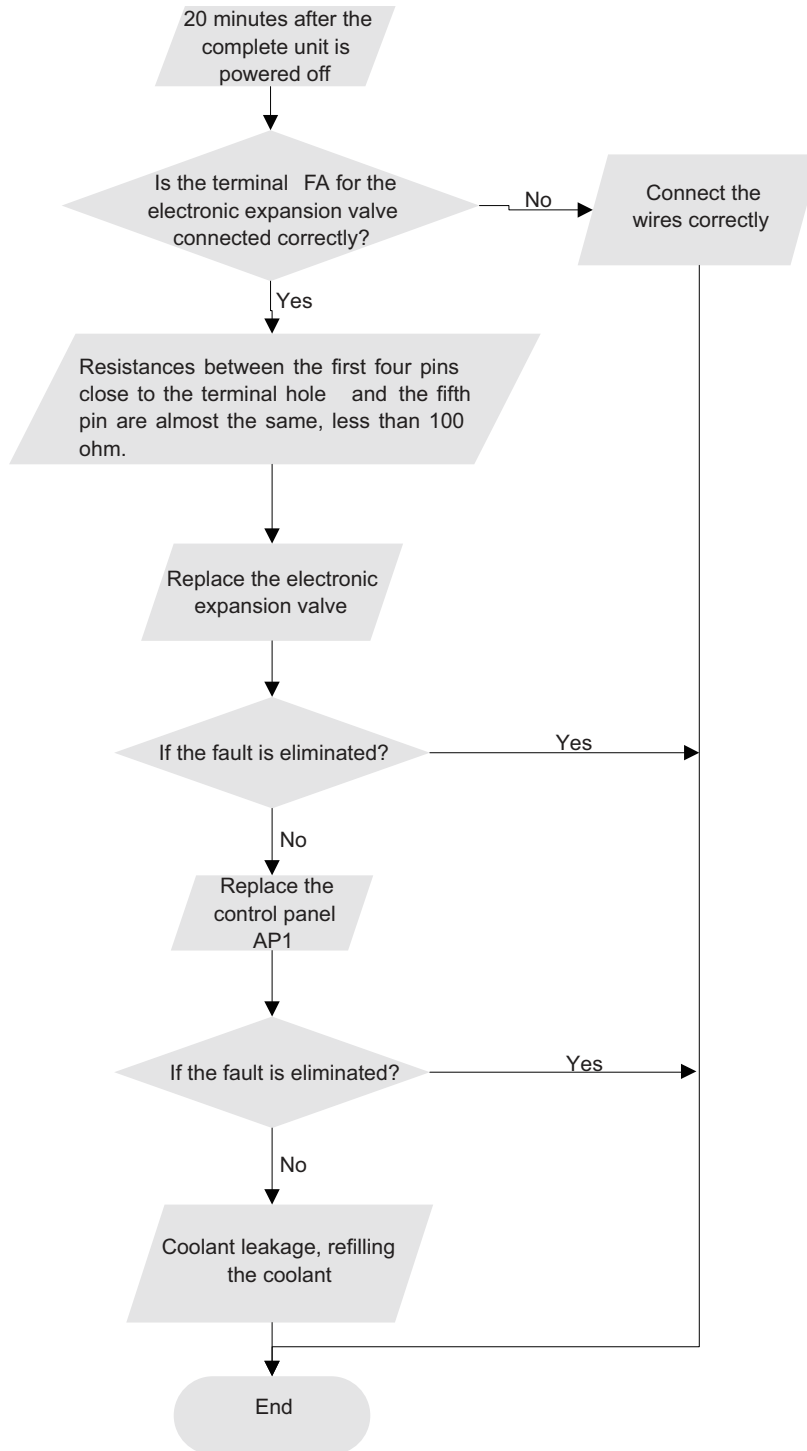

## 7. Communication malfunction: (following AP1 for outdoor unit control board)

Mainly detect:

- Is there any damage for the indoor unit mainboard communication circuit? Is communication circuit damaged?
- Detect the indoor and outdoor units connection wire and indoor and outdoor units inside wiring is connect well or not, if is there any damage?

Fault diagnosis process:

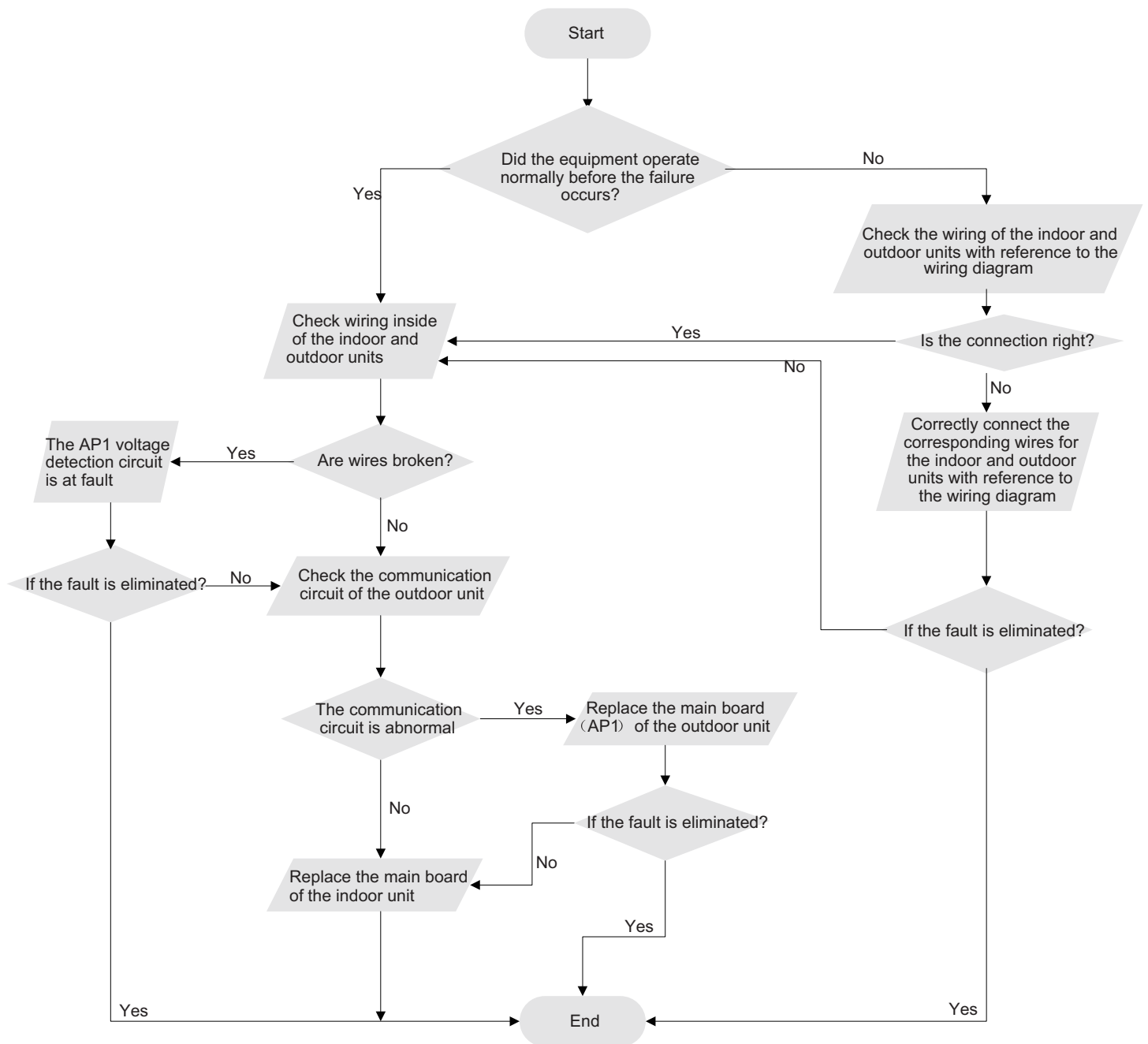



## 8. Malfunction of Overcurrent Protection

Main detection points:

- Is the supply voltage unstable with big fluctuation?
- Is the supply voltage too low with overload?
- Hardware trouble?

Malfunction diagnosis process:

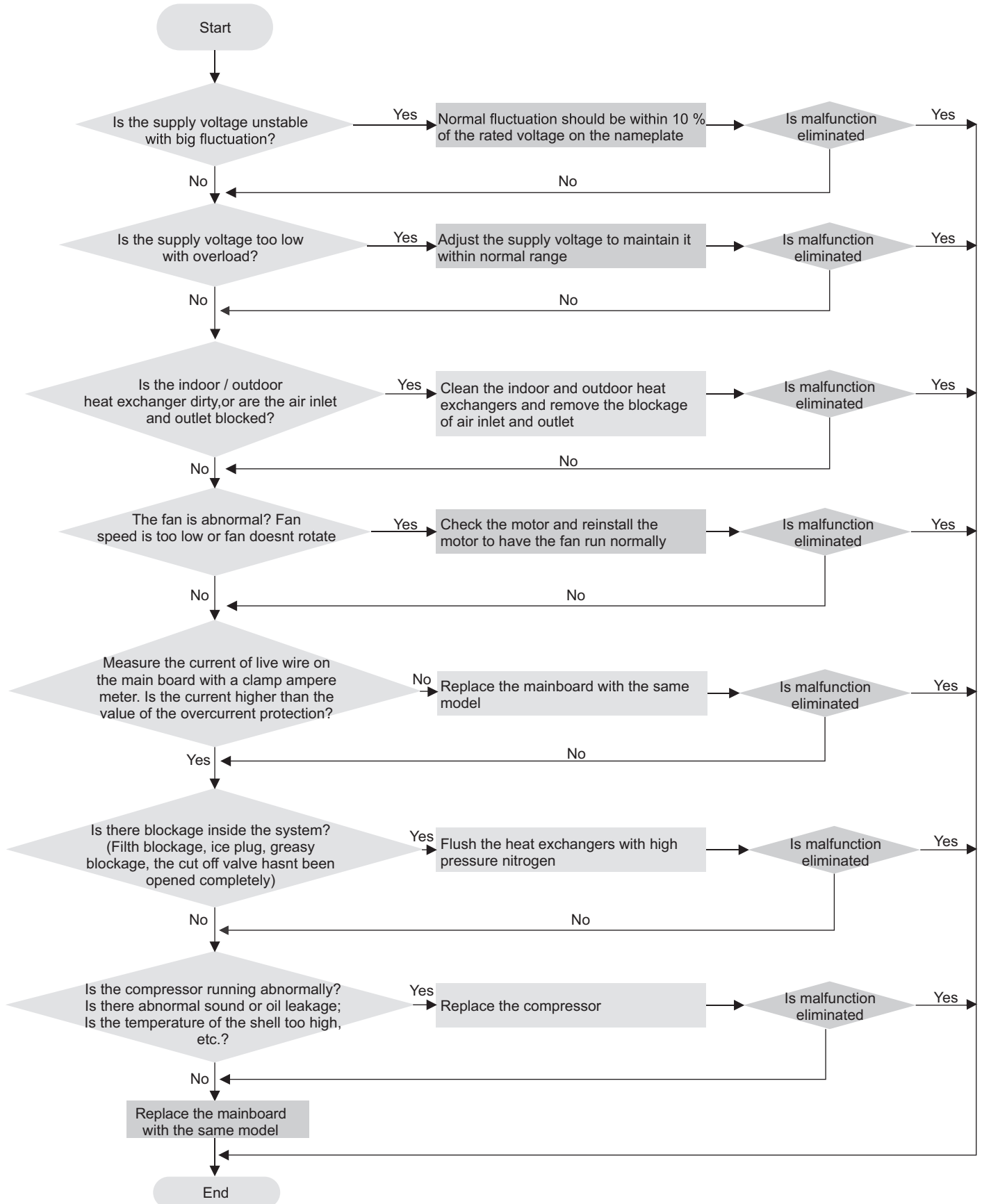

## 9.3 Troubleshooting for Normal Malfunction

### 1. Air Conditioner Cant be Started Up

Possible Causes	Discriminating Method (Air conditioner Status)	Troubleshooting
No power supply, or poor connection for power plug	After energization, operation indicator isnt bright and the buzzer cant give out sound	Confirm whether its due to power failure. If yes, wait for power recovery. If not, check power supply circuit and make sure the power plug is connected well.
Wrong wire connection between indoor unit and outdoor unit, or poor connection for wiring terminals	Under normal power supply circumstances, operation indicator isnt bright after energization	Check the circuit according to circuit diagram and connect wires correctly. Make sure all wiring terminals are connected firmly
Electric leakage for air conditioner	After energization, room circuit breaker trips off at once	Make sure the air conditioner is grounded reliably Make sure wires of air conditioner is connected correctly Check the wiring inside air conditioner. Check whether the insulation layer of power cord is damaged; if yes, place the power cord.
Model selection for air switch is improper	After energization, air switch trips off	Select proper air switch
Malfunction of remote controller	After energization, operation indicator is bright, while no display on remote controller or buttons have no action.	Replace batteries for remote controller Repair or replace remote controller

### 2. Poor Cooling (Heating) for Air Conditioner

Possible Causes	Discriminating Method (Air conditioner Status)	Troubleshooting
Set temperature is improper	Observe the set temperature on remote controller	Adjust the set temperature
Rotation speed of the IDU fan motor is set too low	Small wind blow	Set the fan speed at high or medium
Filter of indoor unit is blocked	Check the filter to see its blocked	Clean the filter
Installation position for indoor unit and outdoor unit is improper	Check whether the installation position is proper according to installation requirement for air conditioner	Adjust the installation position, and install the rainproof and sunproof for outdoor unit
Refrigerant is leaking	Discharged air temperature during cooling is higher than normal discharged wind temperature; Discharged air temperature during heating is lower than normal discharged wind temperature; Units pressure is much lower than regulated range	Find out the leakage causes and deal with it. Add refrigerant.
Malfunction of 4-way valve	Blow cold wind during heating	Replace the 4-way valve
Malfunction of capillary	Discharged air temperature during cooling is higher than normal discharged wind temperature; Discharged air temperature during heating is lower than normal discharged wind temperature; Unitt pressure is much lower than regulated range. If refrigerant isnt leaking, part of capillary is blocked	Replace the capillary
Flow volume of valve is insufficient	The pressure of valves is much lower than that stated in the specification	Open the valve completely
Malfunction of horizontal louver	Horizontal louver cant swing	Refer to point 3 of maintenance method for details
Malfunction of the IDU fan motor	The IDU fan motor cant operate	Refer to troubleshooting for H6 for maintenance method in details
Malfunction of the ODU fan motor	The ODU fan motor cant operate	Refer to point 4 of maintenance method for details
Malfunction of compressor	Compressor cant operate	Refer to point 5 of maintenance method for details

### 3. Horizontal Louver Cant Swing

Possible Causes	Discriminating Method (Air conditioner Status)	Troubleshooting
Wrong wire connection, or poor connection	Check the wiring status according to circuit diagram	Connect wires according to wiring diagram to make sure all wiring terminals are connected firmly
Stepping motor is damaged	Stepping motor cant operate	Repair or replace stepping motor
Main board is damaged	Others are all normal, while horizontal louver cant operate	Replace the main board with the same model

#### 4. ODU Fan Motor Cant Operate

Possible causes	Discriminating method (air conditioner status)	Troubleshooting
Wrong wire connection, or poor connection	Check the wiring status according to circuit diagram	Connect wires according to wiring diagram to make sure all wiring terminals are connected firmly
Capacity of the ODU fan motor is damaged	Measure the capacity of fan capacitor with an universal meter and find that the capacity is out of the deviation range indicated on the nameplate of fan capacitor.	Replace the capacity of fan
Power voltage is a little low or high	Use universal meter to measure the power supply voltage. The voltage is a little high or low	Suggest to equip with voltage regulator
Motor of outdoor unit is damaged	When unit is on, cooling/heating performance is bad and ODU compressor generates a lot of noise and heat.	Change compressor oil and refrigerant. If no better, replace the compressor with a new one

#### 5. Compressor Cant Operate

Possible causes	Discriminating method (air conditioner status)	Troubleshooting
Wrong wire connection, or poor connection	Check the wiring status according to circuit diagram	Connect wires according to wiring diagram to make sure all wiring terminals are connected firmly
Capacity of compressor is damaged	Measure the capacity of fan capacitor with an universal meter and find that the capacity is out of the deviation range indicated on the nameplate of fan capacitor.	Replace the compressor capacitor
Power voltage is a little low or high	Use universal meter to measure the power supply voltage. The voltage is a little high or low	Suggest to equip with voltage regulator
Coil of compressor is burnt out	Use universal meter to measure the resistance between compressor terminals and its 0	Repair or replace compressor
Cylinder of compressor is blocked	Compressor cant operate	Repair or replace compressor

#### 6. Air Conditioner is Leaking

Possible causes	Discriminating method (air conditioner status)	Troubleshooting
Drain pipe is blocked	Water leaking from indoor unit	Eliminate the foreign objects inside the drain pipe
Drain pipe is broken	Water leaking from drain pipe	Replace drain pipe
Wrapping is not tight	Water leaking from the pipe connection place of indoor unit	Wrap it again and bundle it tightly

#### 7. Abnormal Sound and Vibration

Possible causes	Discriminating method (air conditioner status)	Troubleshooting
When turn on or turn off the unit, the panel and other parts will expand and theres abnormal sound	Theres the sound of "PAPA"	Normal phenomenon. Abnormal sound will disappear after a few minutes.
When turn on or turn off the unit, theres abnormal sound due to flow of refrigerant inside air conditioner	Water-running sound can be heard	Normal phenomenon. Abnormal sound will disappear after a few minutes.
Foreign objects inside the indoor unit or therere parts touching together inside the indoor unit	Theres abnormal sound fro indoor unit	Remove foreign objects. Adjust all parts position of indoor unit, tighten screws and stick damping plaster between connected parts
Foreign objects inside the outdoor unit or therere parts touching together inside the outdoor unit	Theres abnormal sound fro outdoor unit	Remove foreign objects. Adjust all parts position of outdoor unit, tighten screws and stick damping plaster between connected parts
Short circuit inside the magnetic coil	During heating, the way valve has abnormal electromagnetic sound	Replace magnetic coil
Abnormal shake of compressor	Outdoor unit gives out abnormal sound	Adjust the support foot mat of compressor, tighten the bolts
Abnormal sound inside the compressor	Abnormal sound inside the compressor	If add too much refrigerant during maintenance, please reduce refrigerant properly. Replace compressor for other circumstances.

# 10. Removal Procedure

## 10.1 Removal Procedure of Indoor Unit

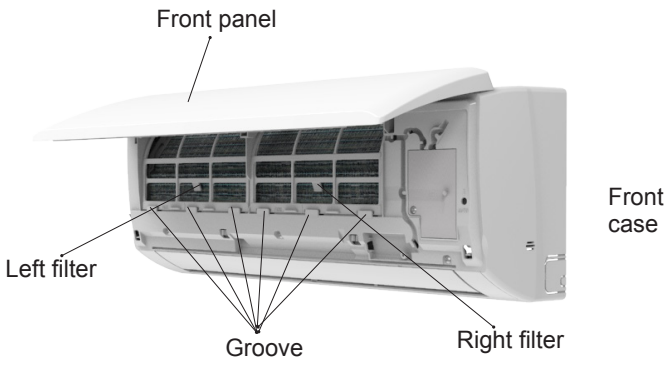
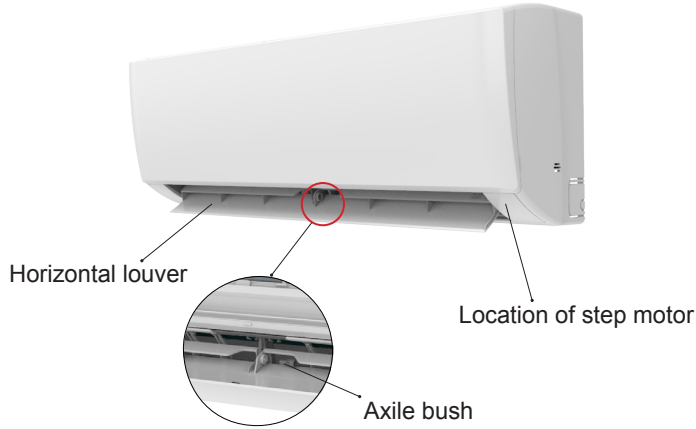
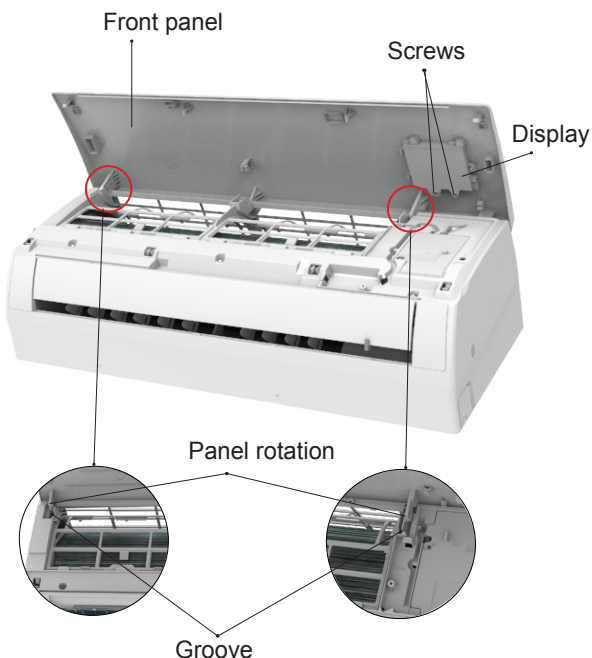

**Caution: discharge the refrigerant completely before removal.**

Step	Procedure
<p><b>1.Remove filter assembly</b></p>	<p>Open the front panel. Push the left filter and right filter until they are separate from the groove on the front panel. Remove the left filter and right filter respectively.</p> 
<p><b>2. Remove horizontal louver</b></p>	<p>Push out the axle bush on horizontal louver. Bend the horizontal louver with hand and then separate the horizontal louver from the crankshaft of step motor to remove it.</p> 
<p><b>3. Remove panel</b></p>	<p>Panel display: Screw off the 2 screws that are locking the display board. Separate the display board from the front panel.</p> <p>b Separate the panel rotation shaft from the groove fixing the front panel and then removes the front panel.</p> 

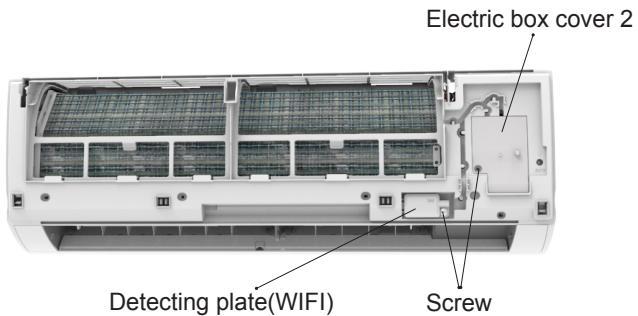
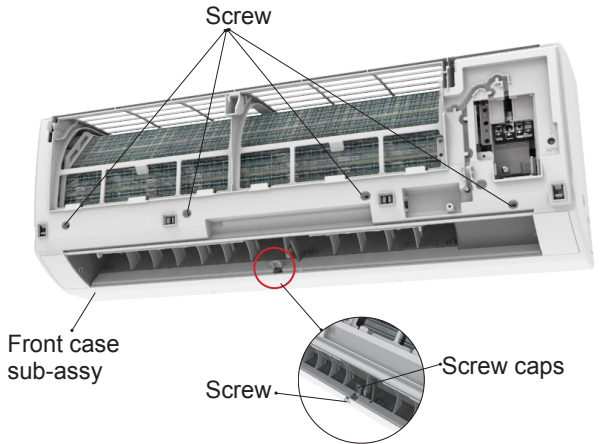
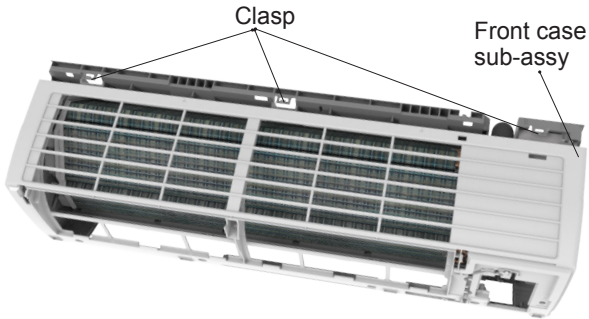
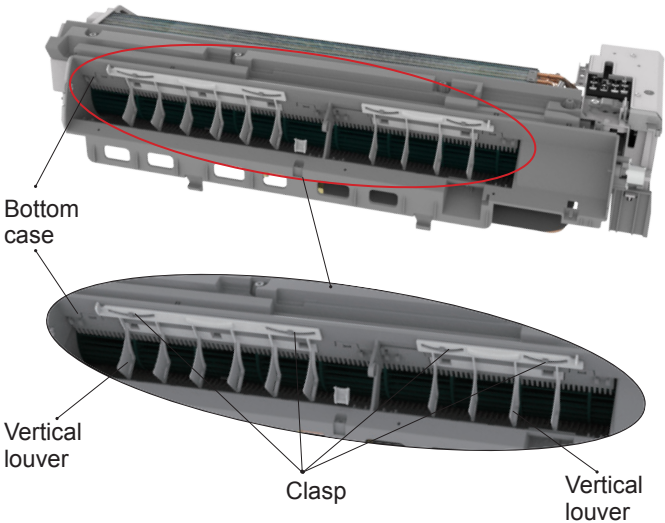
Step	Procedure
<p><b>4. Remove detecting plate(wifi) and electric box cover2</b></p>	<p>Remove the screws fixing detecting plate and remove detecting plate(wifi).</p> <p>Remove the screws fixing electric box cover 2 and remove electric box cover 2.</p> 
<p><b>5. Remove front case sub-assy</b></p> <p>a</p>	<p>Remove the screws fixing front case.</p> <p>Note:</p> <ol style="list-style-type: none"> <li>1.Open the screw caps before removing the screws around the air outlet.</li> <li>2.The quantity of screws fixing the front case sub-assy is different for different models.</li> </ol>  <p>b</p> <p>Loosen the connection clasps between front case sub-assy and bottom case. Lift up the front case sub-assy and take it out.</p> 
<p><b>6. Remove vertical louver</b></p>	<p>Loosen the connection clasps between vertical louver and bottom case to remove vertical louver.</p> 

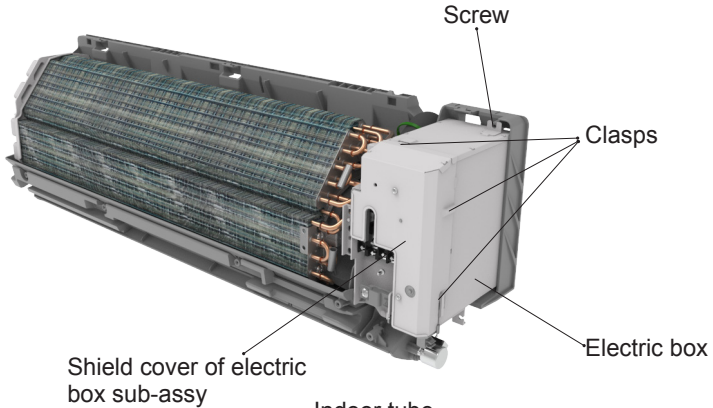
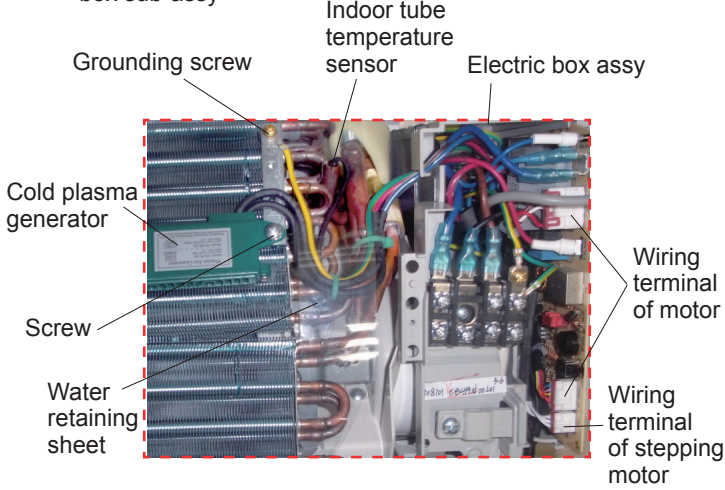
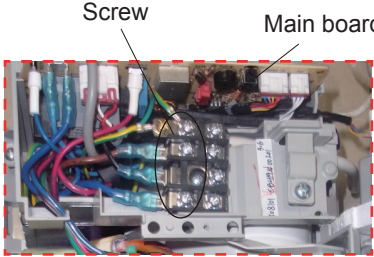
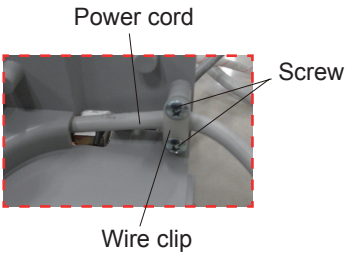
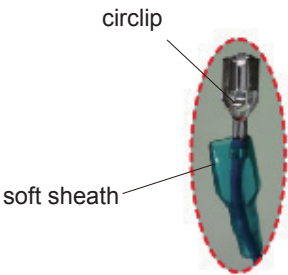
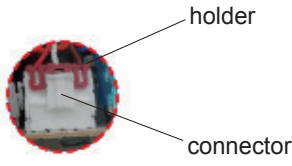
Step	Procedure
<b>7. Remove electric box assy</b>	
a	<p>Loosen the connection clasps between shield cover of electric box sub-assy and electric box, and then remove the shield cover of electric box sub-assy. Remove the screw fixing electric box assy .</p> 
b	<p>① Take off the water retaining sheet. Remove the cold plasma generator by screwing off the locking screw on the generator. ② Take off the indoor tube temperature sensor. ③ Screw off 1 grounding screw. ④ Remove the wiring terminals of motor and stepping motor. ⑤ Remove the electric box assy.</p> 
c	<p>Twist off the screws that are locking each lead wire and rotate the electric box assy. Twist off the screws that are locking the wire clip. Loosen the power cord and remove its wiring terminal. Lift up the main board and take it off.</p>  
d	<p>Instruction: Some wiring terminal of this product is with lock catch and other devices. The pulling method is as below: 1.Remove the soft sheath for some terminals at first, hold the circlip and then pull out the terminals. 2.Pull out the holder for some terminals at first (holder is not available for some wiring terminal), hold the connector and then pull the terminal.</p>  

Step	Procedure
<b>7.Remove evaporator assy</b>	
a	Remove 3 screws fixing evaporator assy.
b	At the back of the unit, remove the screw fixing connection pipe clamp and then remove the connection pipe clamp.
c	First remove the left side of the evaporator from the groove of bottom case and then remove the right side from the clasp on the bottom case.
d	Adjust the position of connection pipe on evaporator slightly and then lift the evaporator upwards to remove it.

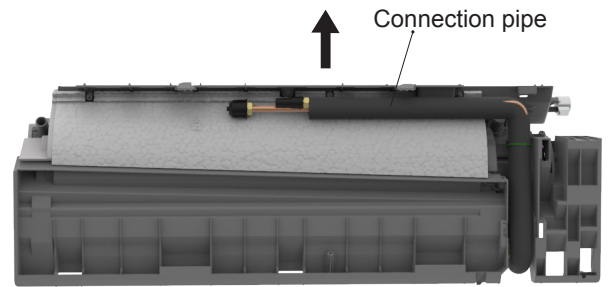
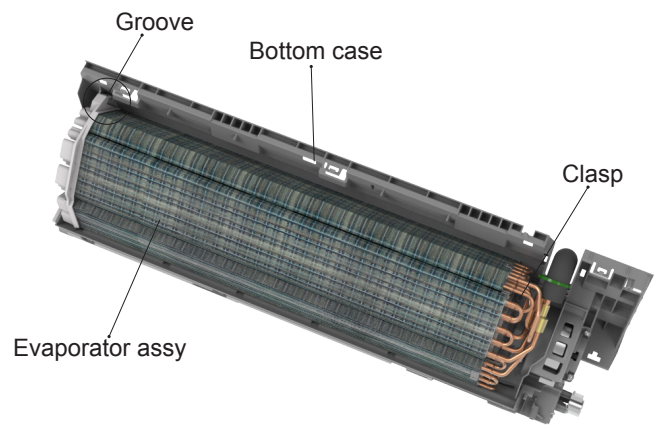
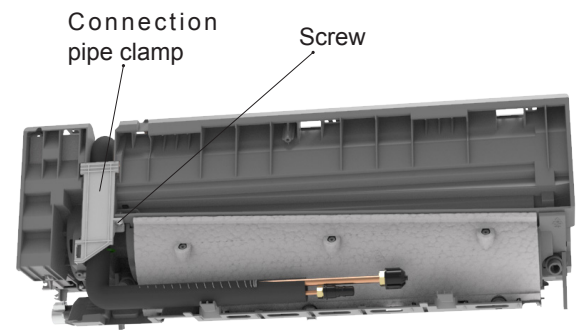
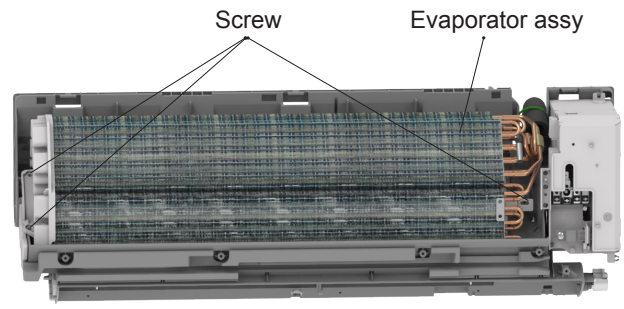

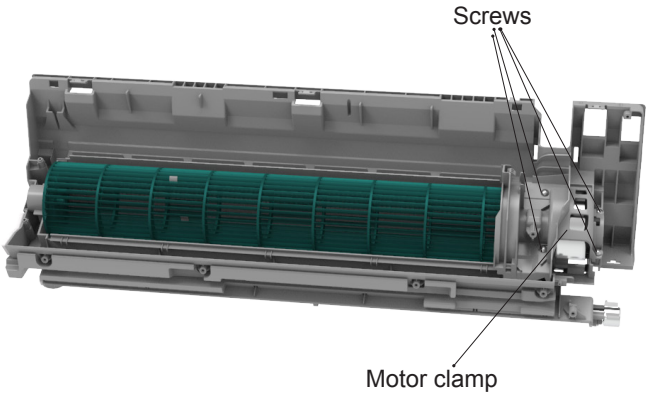
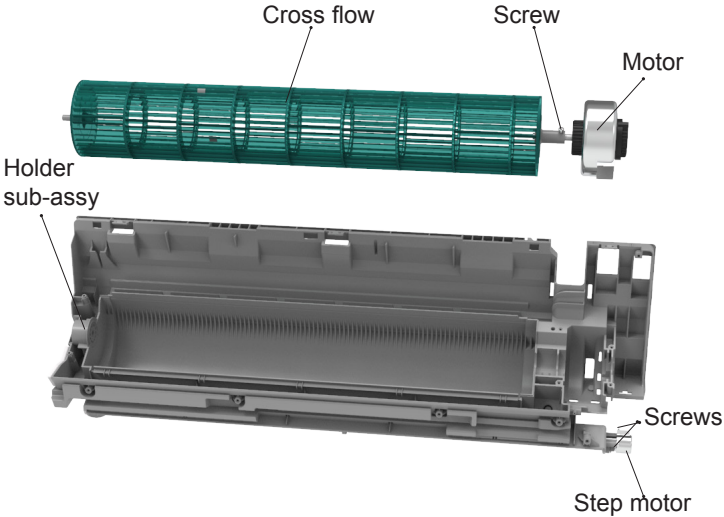
Step	Procedure
<b>9. Remove motor and cross flow blade</b>	
a	<p>Remove the screws fixing motor clamp and then remove the motor clamp.</p> 
b	<p>Remove the screws at the connection place of cross flow blade and motor; lift the motor and cross flow blade upwards to remove them. Remove the bearing holder sub-assy. Remove the screw fixing step motor and then remove the step motor.</p> 







## 10.2 Removal Procedure of Outdoor Unit

X3I ECO PLUS 35 SH

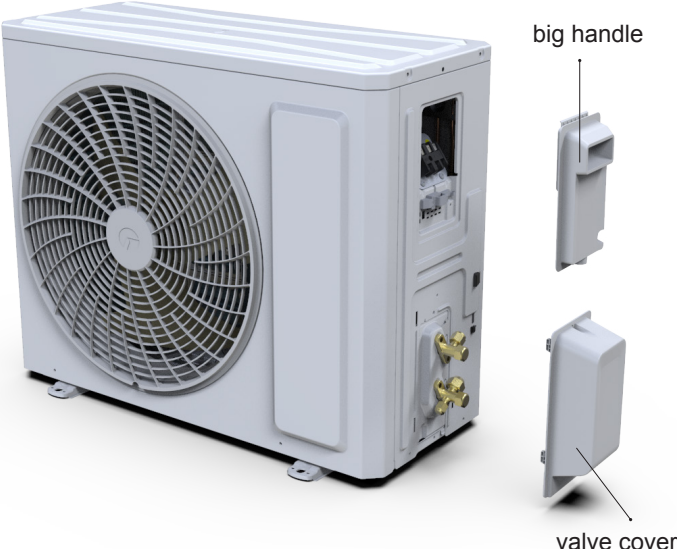





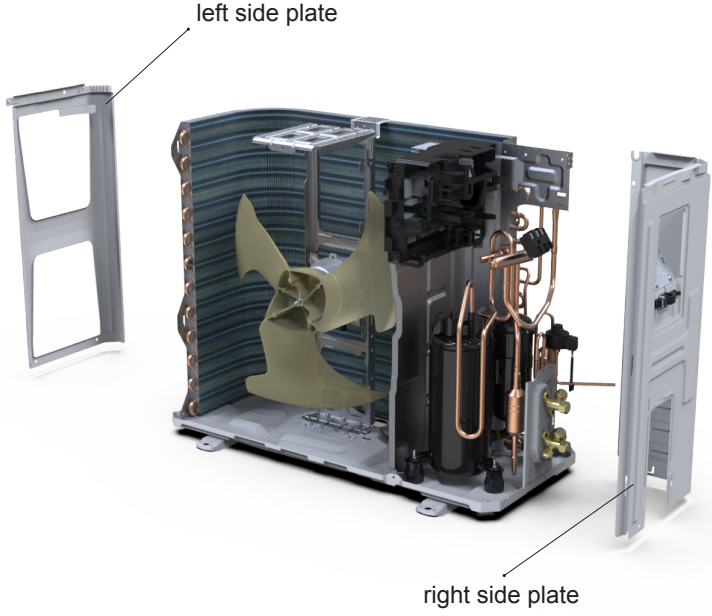

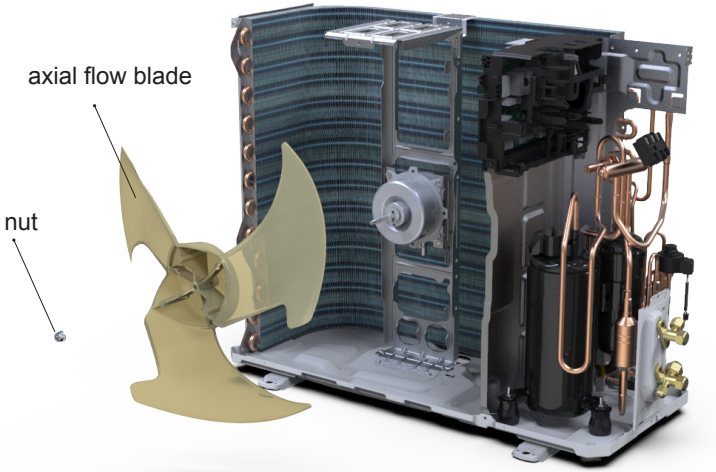
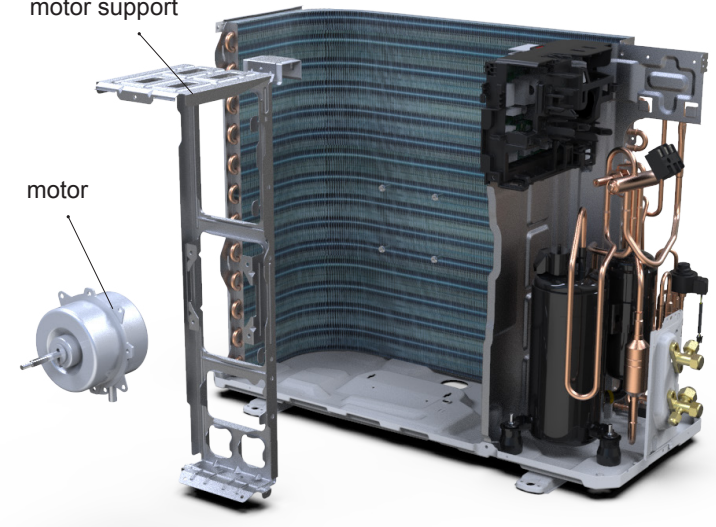
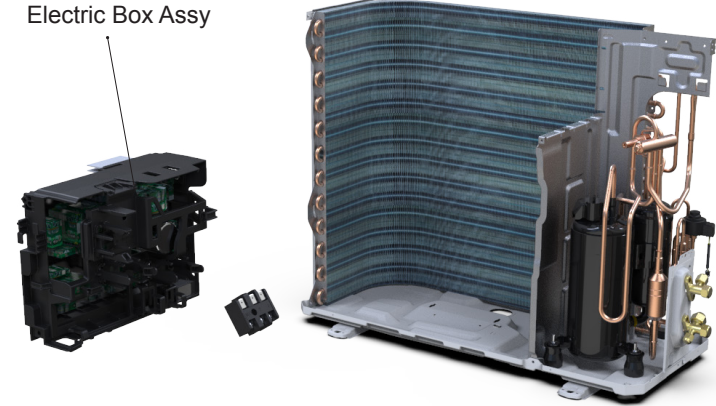
Caution: discharge the refrigerant completely before removal.

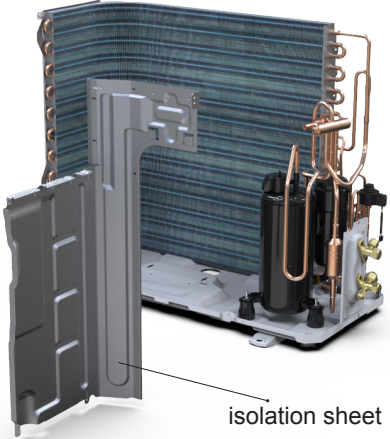
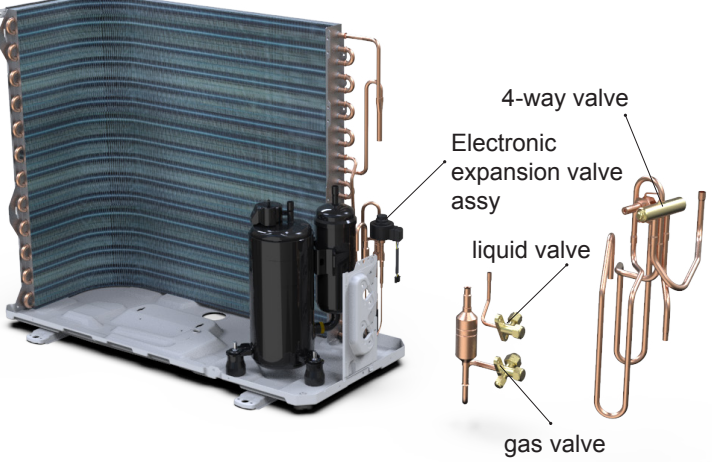
Step	Procedure
<b>1. Before disassembly</b>	
<b>2. Remove big handle and valve cover</b>	<p data-bbox="191 1148 789 1203">Remove the connection screw fixing the big handle and then remove the valve cover.</p> 
<b>3. Remove top cover</b>	<p data-bbox="191 1731 789 1819">Remove connection screws connecting the top panel with the front panel and the right side plate, and then remove the top panel.</p> 

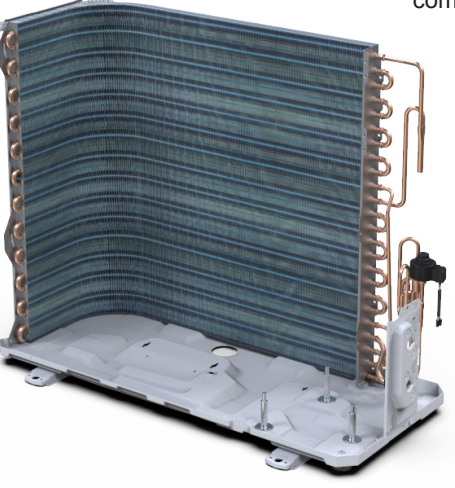
Step	Procedure
<p><b>4. Remove grille</b></p>	<p>Remove connection screws between the front grille and the front panel. Then remove the grille.</p> 
<p><b>5. Remove front panel</b></p>	<p>Remove connection screws connecting the front panel with the chassis and the motor support and then remove the front panel.</p> 
<p><b>6. Remove right side plate and left side plate</b></p>	<p>Remove connection screws connecting the right side plate with the valve support and the electric box. Then remove the right side plate.</p> <p>Remove the screws fixing left side plate and then remove the left side plate.</p> 

Step	Procedure
<p><b>7. Remove axial flow blade</b></p>	<p>Remove the nut on the blade and then remove the axial flow blade.</p>  <p>axial flow blade</p> <p>nut</p>
<p><b>8. Remove motor and motor support</b></p>	<p>Remove the tapping screws fixing the motor and disconnect the leading wire insert of the motor. Then remove the motor. Remove the tapping screws fixing the motor support and lift the motor support to remove it.</p>  <p>motor support</p> <p>motor</p>
<p><b>9. Remove Electric Box Assy</b></p>	<p>Remove screws fixing the electric box subassembly; loosen the wire bundle and unplug the wiring terminals. Then lift the electric box to remove it.</p>  <p>Electric Box Assy</p>

Step	Procedure
<b>10. Remove isolation sheet</b>	
	<p>Remove the screws fixing the isolation sheet and then remove the isolation sheet.</p>  <p>The diagram shows a condenser coil assembly with a grey metal isolation sheet partially detached. A label 'isolation sheet' points to the sheet.</p>
<b>11. Remove compressor</b>	
a	<p>Unsolder the welding joint connecting the capillary, valves and the outlet pipe of condenser to remove the capillary. Do not block the capillary with welding slag during unsoldering.</p>  <p>The diagram shows the condenser coil assembly with several components labeled: '4-way valve', 'Electronic expansion valve assy', 'liquid valve', and 'gas valve'.</p>
b	<p>Remove the 2 screws fixing the gas valve and unsolder the welding joint between the gas valve and the air-return pipe to remove the gas valve. (NOTE: Discharge the refrigerant completely before unsoldering; when unsoldering, wrap the gas valve with a wet cloth completely to avoid damage to the valve caused by high temperature).</p> <p>Remove the 2 screws fixing the liquid valve and unsolder the welding joint connecting the liquid valve to the Y-type pipe to remove the liquid valve.</p>
c	<p>Unsolder pipes connecting with compressor.</p>  <p>The diagram shows a black compressor unit with a label 'compressor' pointing to it.</p>
d	<p>Remove the 3 foot nuts on the compressor and then remove the compressor.</p>  <p>The diagram shows the condenser coil assembly with the compressor removed, leaving three foot nuts on the base.</p>

Step	Procedure
<p><b>1. Before disassembly</b></p>	
<p><b>2. Remove big handle and valve cover</b></p>	<p>Remove the screws fixing big handle, valve cover and then remove them.</p> 
<p><b>3. Remove top cover</b></p>	<p>Remove the screws fixing top panel and then remove the top panel.</p> 

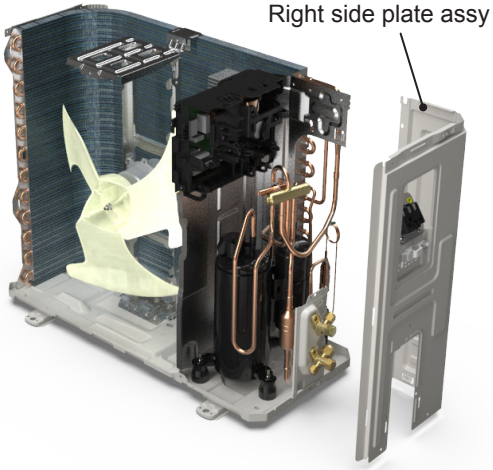
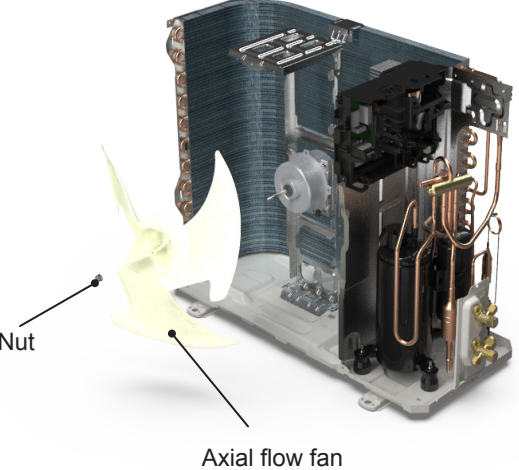
Step	Procedure
<p><b>4. Remove front panel assy</b></p>	<p>Remove connection screws connecting the front panel assy with the chassis and the motor support, and then remove the front panel assy.</p> 
<p><b>5. Remove right side plate assy</b></p>	<p>Rescrew the ground screws, remove the ground wires, loosen the screws fixing terminal board, remove the terminal board, rescrew the screws fixing the right plate, and remove the right side plate assy.</p> 
<p><b>6. Remove axial flow fan</b></p>	<p>Remove the nut on the fan and then remove the axial flow fan.</p> 

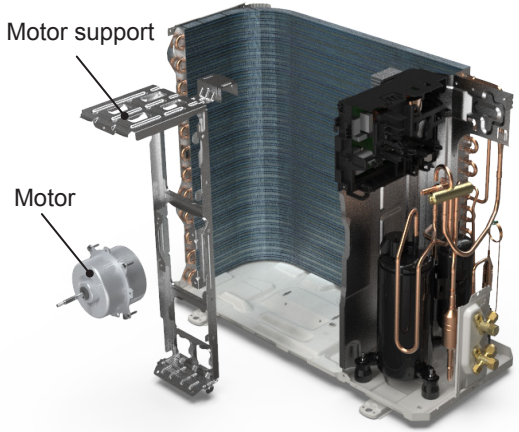
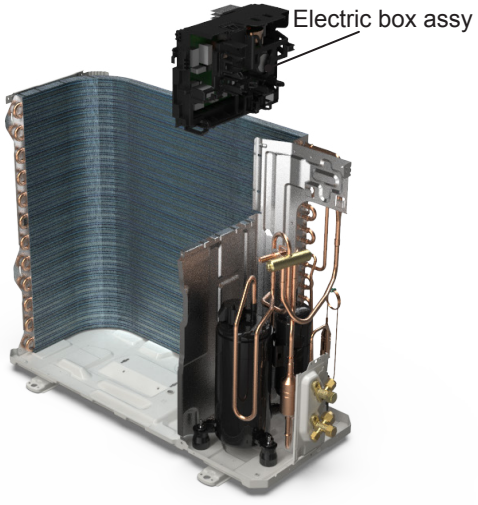
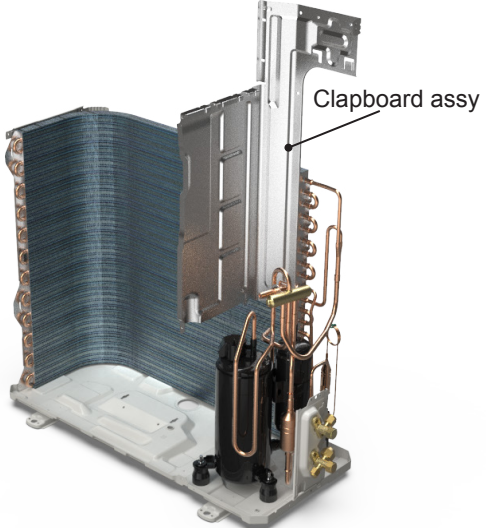
Step	Procedure
<p><b>7. Remove motor support and motor</b></p>	<p>Remove the screws fixing the motor support and lift the motor support to remove it. Remove the screws fixing the motor and then remove the motor.</p> 
<p><b>8. Remove electric box assy</b></p>	<p>Remove the terminals, lift up and rotate the electrical box assy to the right so that the snaps on the clapboard are removed and the electrical box assy are removed.</p> 
<p><b>9. Remove clapboard assy</b></p>	<p>Remove the screws fixing the clapboard assy and then remove the clapboard assy.</p> 

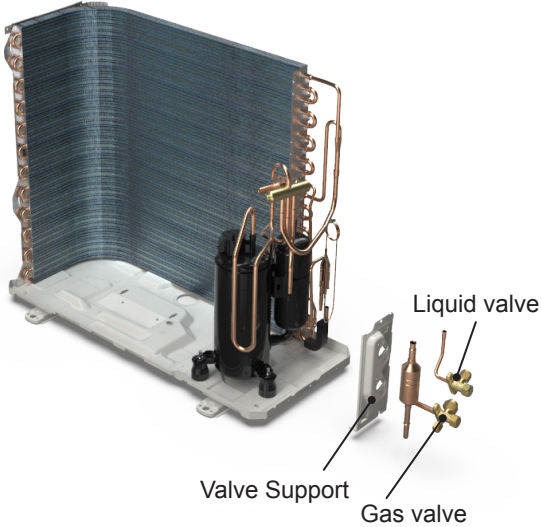
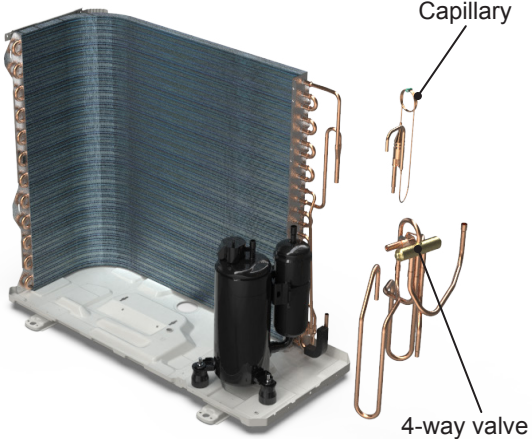
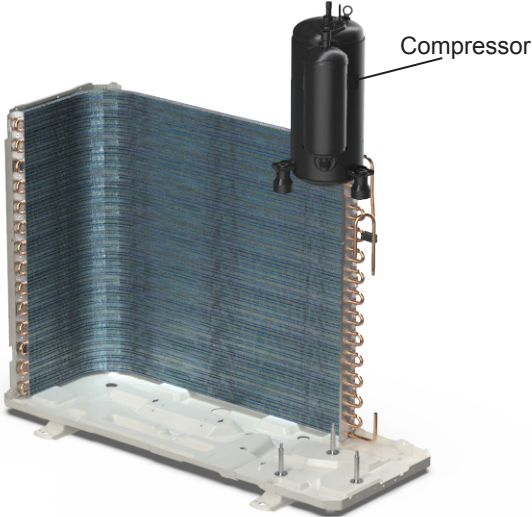
Step	Procedure
<p><b>10. Remove gas valve and liquid valve</b></p> <p>Remove the valve support block, remove the screws fixing the gas valve and the liquid valve, unsolder the welding joint connecting the gas valve and the liquid valve, remove them.</p> <p>Note: Discharge the refrigerant completely before unsoldering; when unsoldering, wrap the gas valve with a wet cloth completely to avoid damage to the valve caused by high temperature.</p>	
<p><b>11. Remove 4-way valve and capillary</b></p> <p>Unsolder the welding joints connecting capillary, and then remove it.</p> <p>Unsolder the welding joints connecting the 4-way valve assembly with capillary sub-assembly, compressor and condenser; remove the 4-way valve. Cooling only unit removes Discharge Tube and Inhalation Tube.</p> <p>Note: Before unsoldering the welding joint, wrap the 4-way valve with a wet cloth completely to avoid damage to the valve caused by high temperature.</p>	
<p><b>12. Remove compressor</b></p> <p>Remove the 3 foot nuts on the compressor and then remove the compressor.</p>	





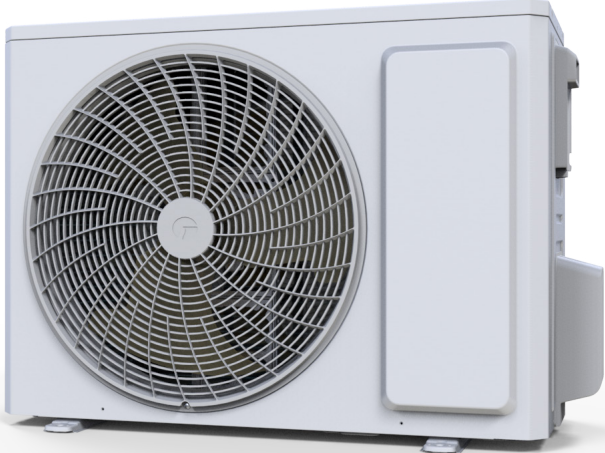
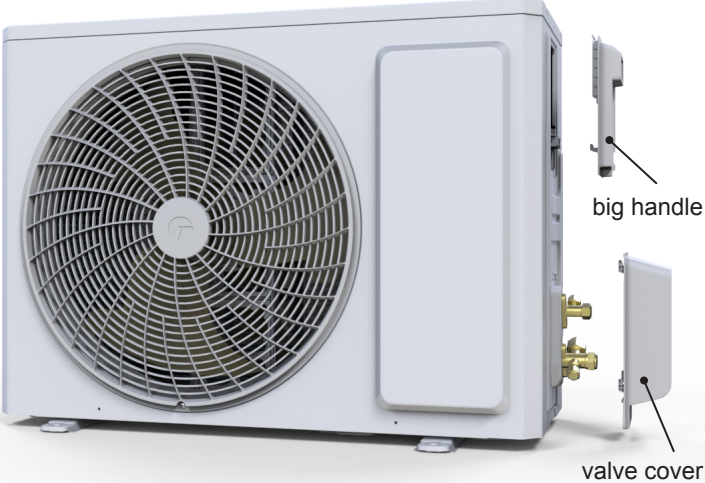
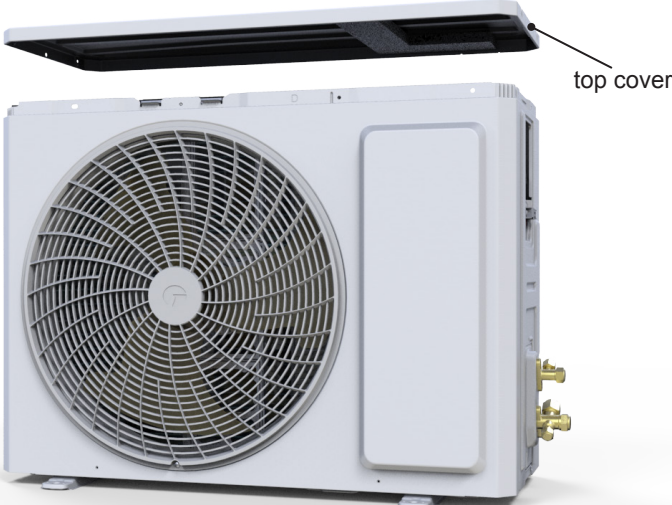

**Caution: discharge the refrigerant completely before removal.**

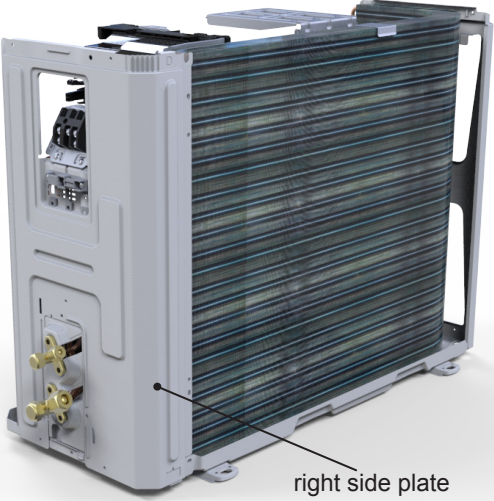
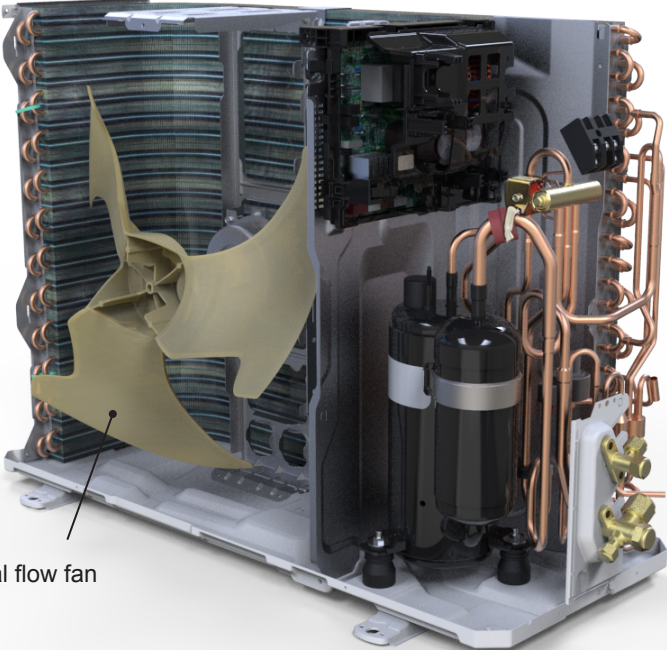
Step	Procedure
<p><b>1. Before disassembly</b></p>	
<p><b>2. Remove big handle and valve cover</b></p>	<p>Remove the screws fixing big handle, valve cover and then remove them.</p> 
<p><b>3. Remove top cover</b></p>	<p>Remove the screws fixing top panel and then remove the top panel.</p> 

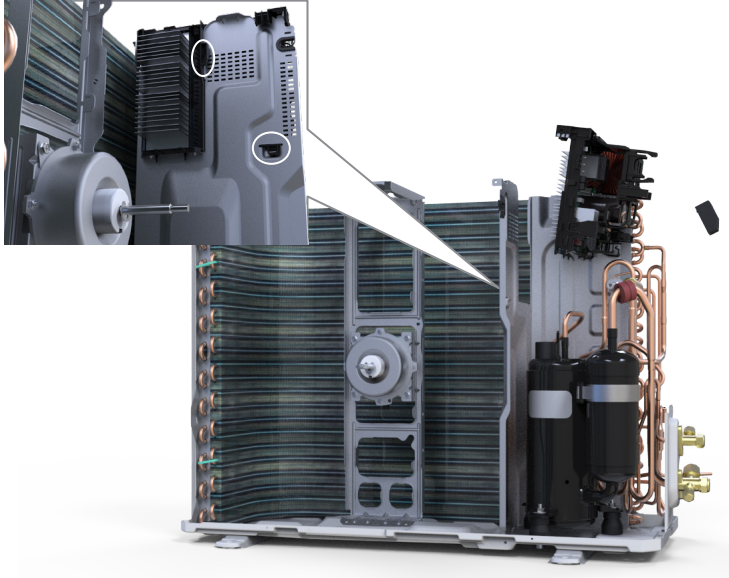
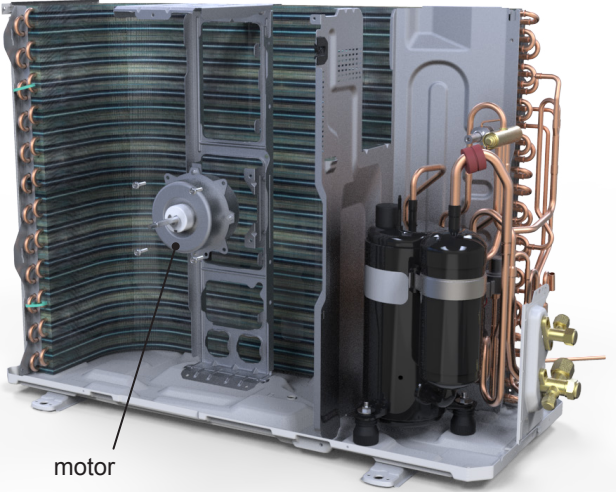
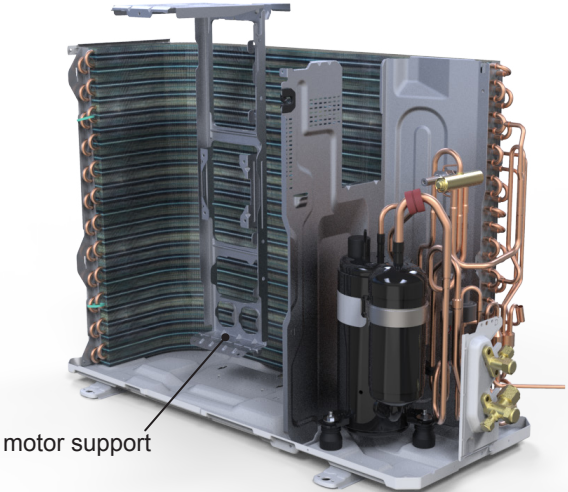
Step	Procedure
<p><b>4. Remove front panel assy</b></p>	<p>Remove connection screws connecting the front panel assy with the chassis and the motor support, and then remove the front panel assy.</p> 
<p><b>5. Remove right side plate assy</b></p>	<p>Rescrew the ground screws, remove the ground wires, loosen the screws fixing terminal board, remove the terminal board, rescrew the screws fixing the right plate, and remove the right side plate assy.</p> 
<p><b>6. Remove axial flow fan</b></p>	<p>Remove the nut on the fan and then remove the axial flow fan.</p> 

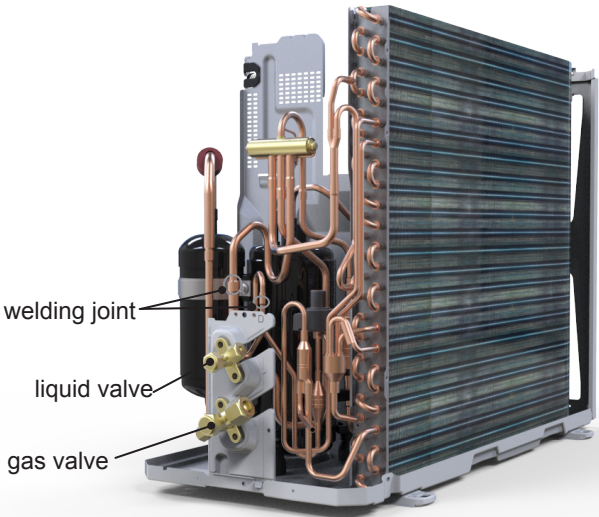
Step	Procedure
<p><b>7. Remove electric box assy</b></p>	<p>Remove the terminals, lift up and rotate the electrical box assy to the right so that the snaps on the clapboard are removed and the electrical box assy are removed.</p> 
<p><b>8. Remove motor</b></p>	<p>Remove the screws fixing the motor and then remove the motor.</p> 
<p><b>9. Remove motor support</b></p>	<p>Remove the screws fixing the motor support and lift the motor support to remove it.</p> 

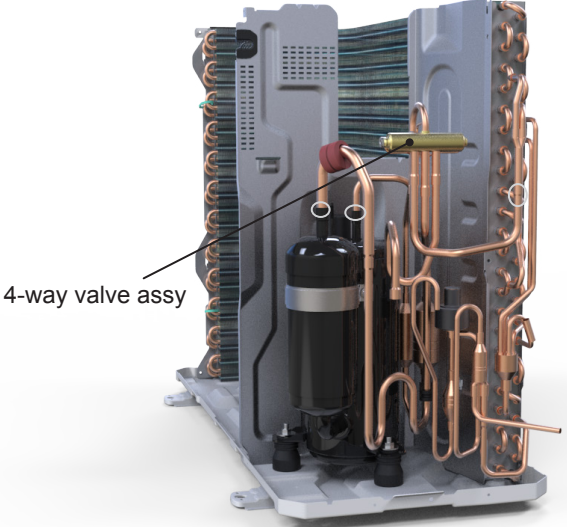
Step	Procedure
<p><b>10. Remove gas valve and liquid valve</b></p> <p>Remove the valve support block, remove the screws fixing the gas valve and the liquid valve, unsolder the welding joint connecting the gas valve and the liquid valve, remove them.</p> <p>Note: Discharge the refrigerant completely before unsoldering; when unsoldering, wrap the gas valve with a wet cloth completely to avoid damage to the valve caused by high temperature.</p>	 <p>welding joint</p> <p>liquid valve</p> <p>gas valve</p>
<p><b>11. Remove valve support</b></p> <p>Remove the screws fixing valve support, then remove the valve support.</p>	 <p>valve support</p>
<p><b>12. Remove 4-way valve assy</b></p> <p>Unsolder the welding joints connecting the 4-way valve assy, remove the 4-way valve.</p> <p>Note: Before unsoldering the welding joint, wrap the 4-way valve with a wet cloth completely to avoid damage to the valve caused by high temperature.</p>	 <p>4-way valve assy</p>

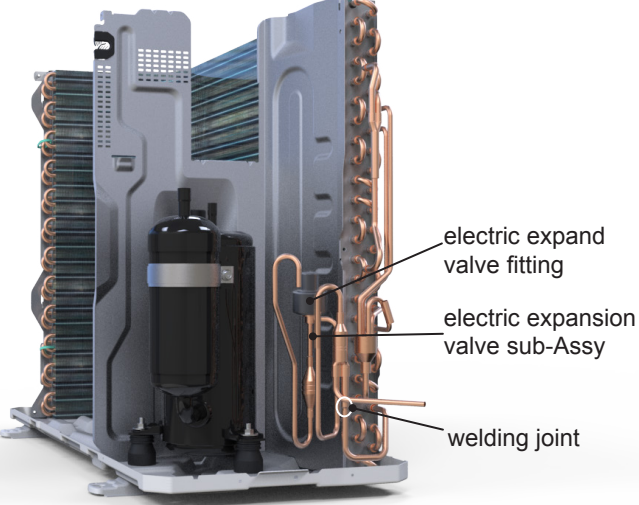
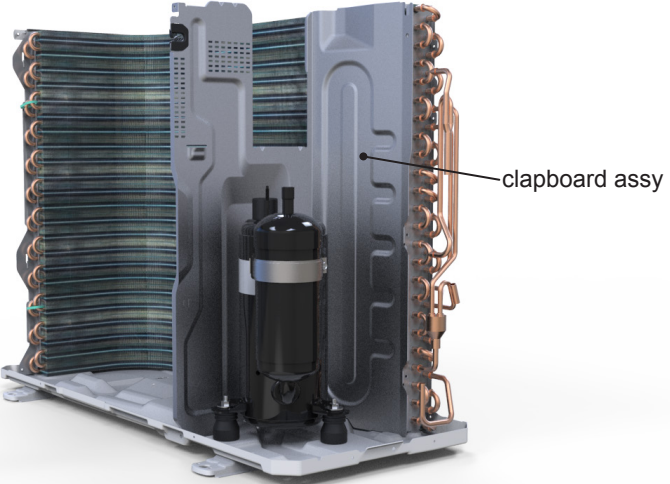
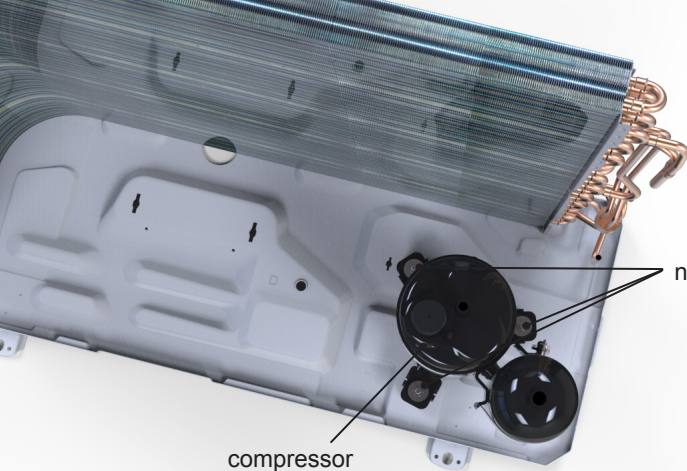
Step	Procedure
<p><b>13. Remove isolation sheet</b></p>	<p>Remove the screws fixing the isolation sheet and then remove the isolation sheet.</p> 
<p><b>14. Remove clapboard assy</b></p>	<p>Remove the screws fixing the clapboard assy and then remove the clapboard assy.</p> 
<p><b>15. Remove compressor</b></p>	<p>Remove the 3 foot nuts on the compressor and then remove the compressor.</p> 

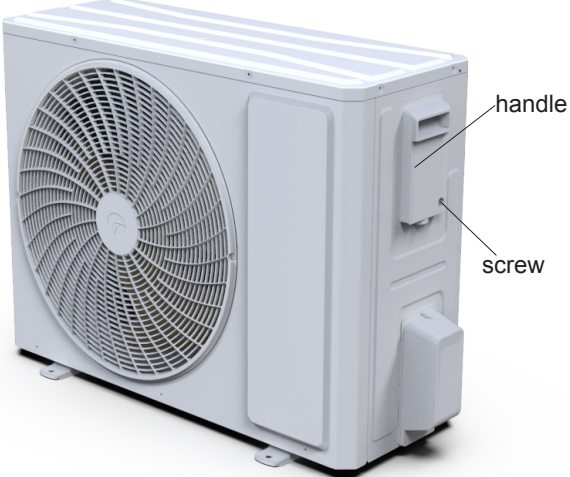
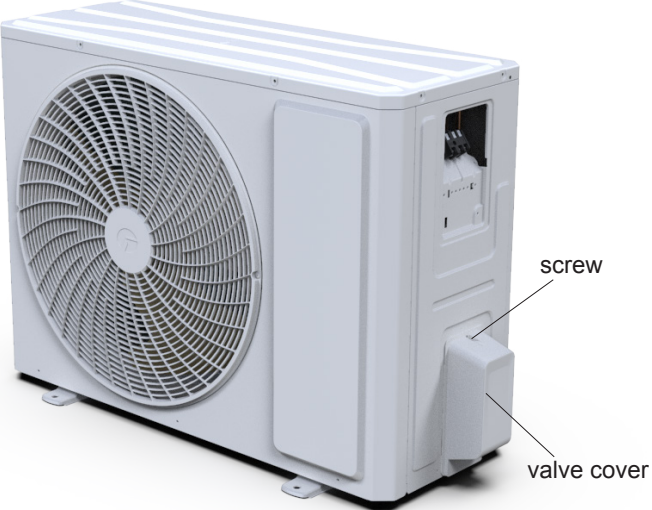
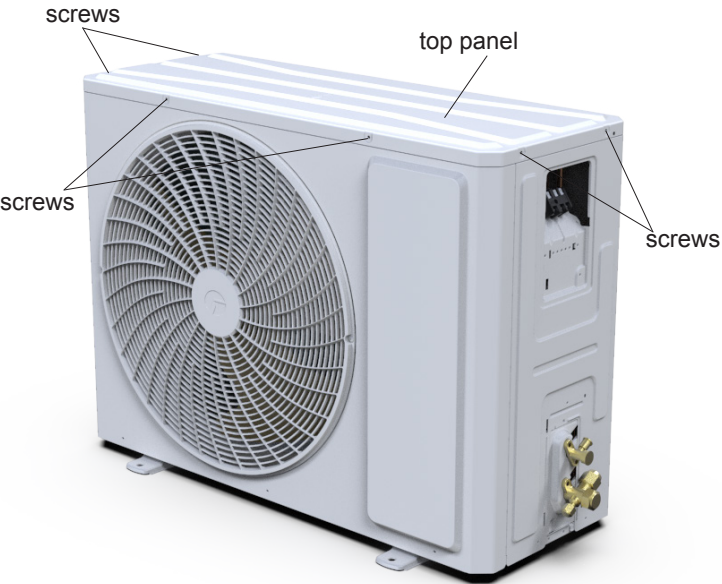
Step	Procedure
<p><b>1. Remove handle</b></p>	<p>Remove the screw fixing the handle and then remove the handle.</p>  <p>The diagram shows the outdoor unit from a three-quarter perspective. A label 'handle' points to the small rectangular protrusion on the right side of the unit. Another label 'screw' points to the screw that secures this handle to the unit's casing.</p>
<p><b>2. Remove valve cover</b></p>	<p>Remove the screw fixing the valve cover and then remove the valve cover.</p>  <p>The diagram shows the outdoor unit from a three-quarter perspective. A label 'screw' points to the screw that secures the valve cover. Another label 'valve cover' points to the rectangular cover on the right side of the unit, which protects the service valves.</p>
<p><b>3. Remove top panel</b></p>	<p>Remove the screws fixing the top panel and then remove the top panel.</p>  <p>The diagram shows the outdoor unit from a three-quarter perspective. A label 'top panel' points to the top surface of the unit. Multiple labels 'screws' point to the screws that secure the top panel to the unit's frame.</p>

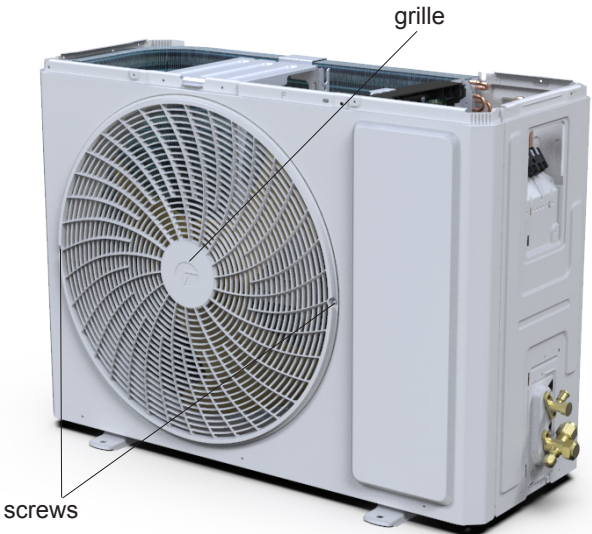
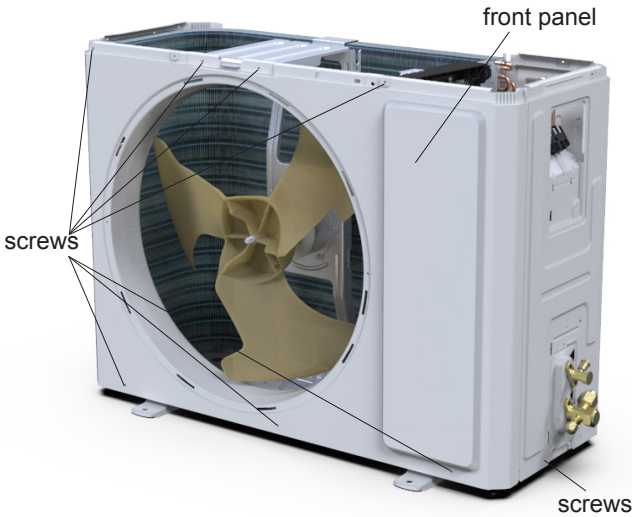
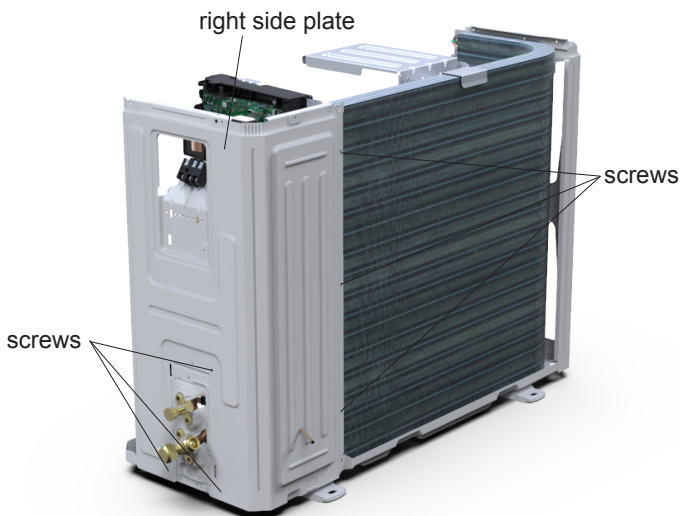
Step	Procedure
<p><b>4. Remove grille</b></p>	<p>Remove the screws fixing the grille and then remove the panel grille.</p> 
<p><b>5. Remove front panel</b></p>	<p>Remove screws fixing the front panel and then remove the front panel.</p> 
<p><b>6. Remove right side plate</b></p>	<p>Remove screws fixing connecting the front panel with the chassis and the motor support, and then remove the right side plate.</p> 

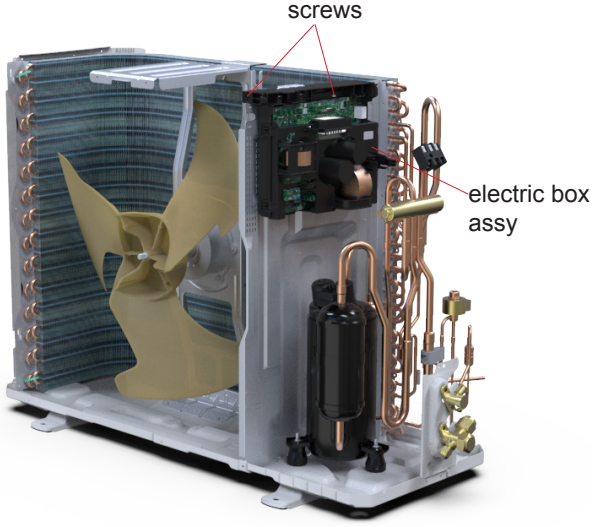
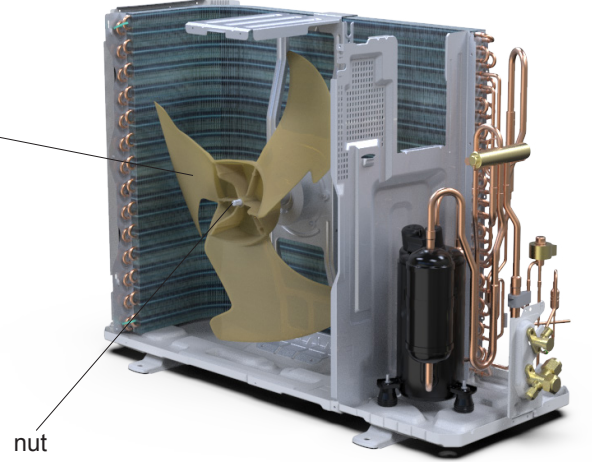
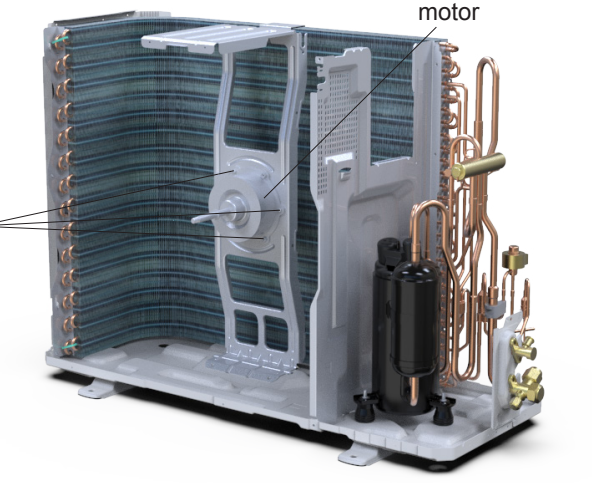
Step	Procedure
<p><b>7. Remove electric box assy</b></p>	<p>Remove the screws fixing the electricbox; loosen the wire bundle; pull out the wiring terminals and then pull electric boxupwards to remove it.</p>  <p>The diagram shows the internal components of the unit. A black electric box assembly is mounted on top of the compressor. Red lines point to several screws securing it. A label 'electric box assy' points to the entire assembly. The compressor and other internal parts are visible below.</p>
<p><b>8. Remove axial flow blade</b></p>	<p>Remove nut fixing the blade and then remove the blade.</p>  <p>The diagram shows the axial flow fan assembly. A label 'axial flow blade' points to the fan blades. Another label 'nut' points to the nut that secures the fan to the motor shaft. The fan is mounted on a white plastic frame.</p>
<p><b>9. Remove motor</b></p>	<p>Remove screws fixing the motor and then remove the motor.</p>  <p>The diagram shows the motor assembly. A label 'motor' points to the black cylindrical motor. Two labels 'screws' point to the screws that secure the motor to the white plastic frame. The compressor and other internal parts are visible below.</p>

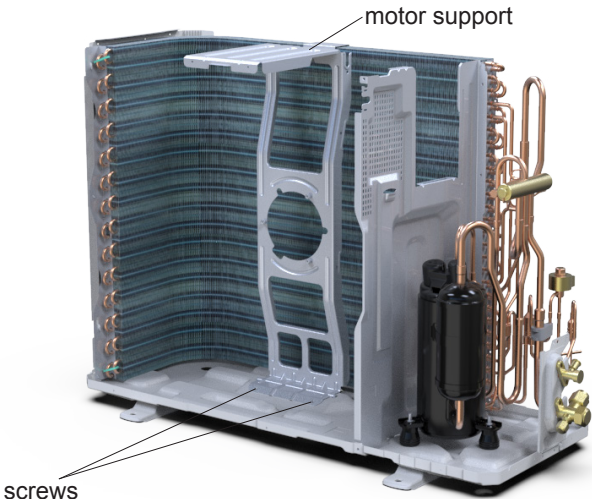
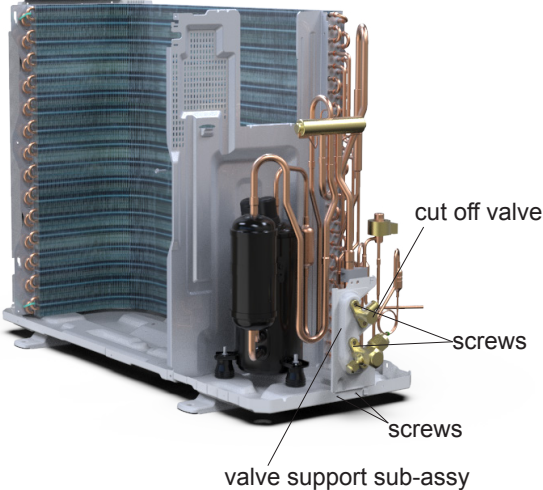
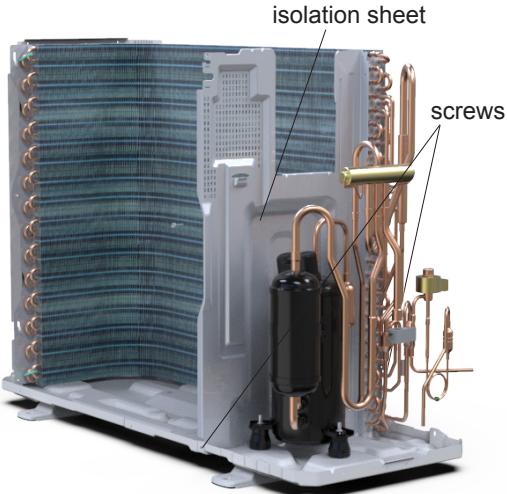

Step	Procedure
<p><b>10. Remove motor support</b></p>	<p>Remove screws fixing the motor support and then remove the motor support.</p> 
<p><b>11. Remove cut off valve and valve support sub-assy</b></p>	<p>Remove screws fixing the cut off valve and then remove the cut off valve; Remove screws fixing the valve support subassy and then remove the valve support subassy. Note: When pulling out the wiring terminal, pay attention to loose the clasp and don't pull it so hard.</p> 
<p><b>12. Remove isolation sheet</b></p>	<p>Remove the screws fixing the isolation sheet and then remove the isolation sheet.</p> 

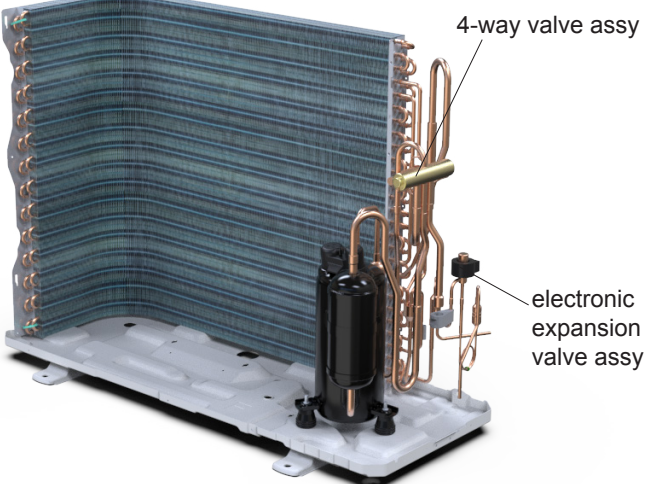
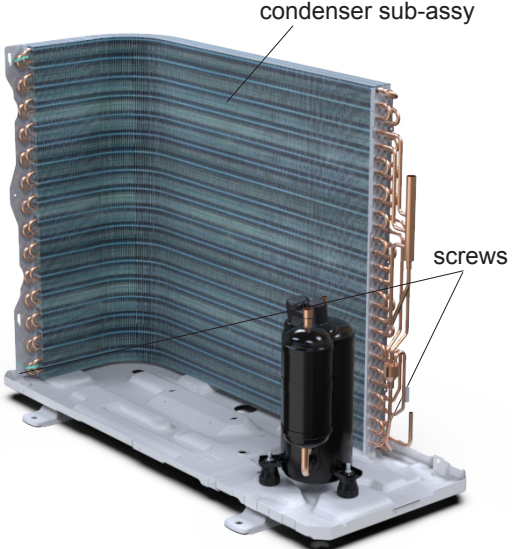
Step	Procedure
<p><b>13. Remove left side plate</b></p>	<p>Remove the screws fixing the left side plate and the chassis, and then remove the left side plate.</p> 
<p><b>14. Remove 4-way valve assy and electronic expansion valve assy</b></p>	<p>Unsolder the welding joints connecting electronic expansion valve assy the 4-way valve assy with capillary sub-assy, compressor and condenser; remove the electronic expansion valve assy and 4-way valve.</p> <p>Note: Before unsoldering the welding joint, wrap the 4-way valve with a wet cloth completely to avoid damage to the valve caused by high temperature.</p> 
<p><b>15. Remove condenser sub-assy</b></p>	<p>Remove the screws fixing the condenser and chassis, and then lift the condenser upwards to remove it.</p> 

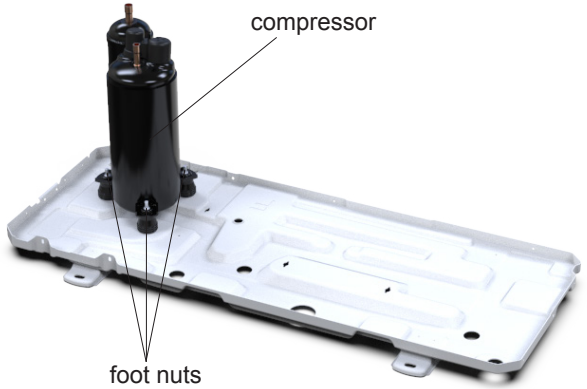
Step	Procedure
<b>16. Remove compressor</b>	<p data-bbox="191 535 792 600">Remove the 3 foot nuts on the compressor and then remove the compressor.</p> 

# Appendix

## Appendix 1: Reference Sheet of Celsius and Fahrenheit

Conversion formula for Fahrenheit degree and Celsius degree:  $T_f = T_c \times 1.8 + 32$

### Set temperature

Fahrenheit display temperature (°F)	Fahrenheit (°F)	Celsius (°C)	Fahrenheit display temperature (°F)	Fahrenheit (°F)	Celsius (°C)	Fahrenheit display temperature (°F)	Fahrenheit (°F)	Celsius (°C)
61	60.8	16	69/70	69.8	21	78/79	78.8	26
62/63	62.6	17	71/72	71.6	22	80/81	80.6	27
64/65	64.4	18	73/74	73.4	23	82/83	82.4	28
66/67	66.2	19	75/76	75.2	24	84/85	84.2	29
68	68	20	77	77	25	86	86	30

### Ambient temperature

Fahrenheit display temperature (°F)	Fahrenheit (°F)	Celsius (°C)	Fahrenheit display temperature (°F)	Fahrenheit (°F)	Celsius (°C)	Fahrenheit display temperature (°F)	Fahrenheit (°F)	Celsius (°C)
32/33	32	0	55/56	55.4	13	79/80	78.8	26
34/35	33.8	1	57/58	57.2	14	81	80.6	27
36	35.6	2	59/60	59	15	82/83	82.4	28
37/38	37.4	3	61/62	60.8	16	84/85	84.2	29
39/40	39.2	4	63	62.6	17	86/87	86	30
41/42	41	5	64/65	64.4	18	88/89	87.8	31
43/44	42.8	6	66/67	66.2	19	90	89.6	32
45	44.6	7	68/69	68	20	91/92	91.4	33
46/47	46.4	8	70/71	69.8	21	93/94	93.2	34
48/49	48.2	9	72	71.6	22	95/96	95	35
50/51	50	10	73/74	73.4	23	97/98	96.8	36
52/53	51.8	11	75/76	75.2	24	99	98.6	37
54	53.6	12	77/78	77	25			

## Appendix 2: Configuration of Connection Pipe

- Standard length of connection pipe (More details please refer to the specifications.)
- Min length of connection pipe for the unit with standard connection pipe of 5m, there is no limitation for the min length of connection pipe. For the unit with standard connection pipe of 7.5m and 8m, the min length of connection pipe is 3m.
- Max. length of connection pipe and max. high difference. (More details please refer to the specifications.)
- The additional refrigerant oil and refrigerant charging required after prolonging connection pipe
  - After the length of connection pipe is prolonged for 10m at the basis of standard length, you should add 5ml of refrigerant oil for each additional 5m of connection pipe.
  - The calculation method of additional refrigerant charging amount (on the basis of liquid pipe):
    - Basing on the length of standard pipe, add refrigerant according to the requirement as shown in the table. The additional refrigerant charging amount per meter is different according to the diameter of liquid pipe. See the following sheet.
    - Additional refrigerant charging amount = prolonged length of liquid pipe X additional refrigerant charging amount per meter

Additional refrigerant charging amount for R32

Diameter of connection pipe		Indoor unit throttle	Outdoor unit throttle	
Liquid pipe	Gas pipe	Cooling only, cooling and heating (g / m)	Cooling only(g/m)	Cooling and heating(g/m)
1/4"	3/8" or 1/2"	16	12	16
1/4" or 3/8"	5/8" or 3/4"	40	12	40
1/2"	3/4" or 7/8"	80	24	96
5/8"	1" or 1 1/4"	136	48	96
3/4"	/	200	200	200
7/8"	/	280	280	280

## Appendix 3: Pipe Expanding Method

### ⚠ Note:

Improper pipe expanding is the main cause of refrigerant leakage. Please expand the pipe according to the following steps:

#### A: Cut the pipe

- Confirm the pipe length according to the distance of indoor unit and outdoor unit.
- Cut the required pipe with pipe cutter.

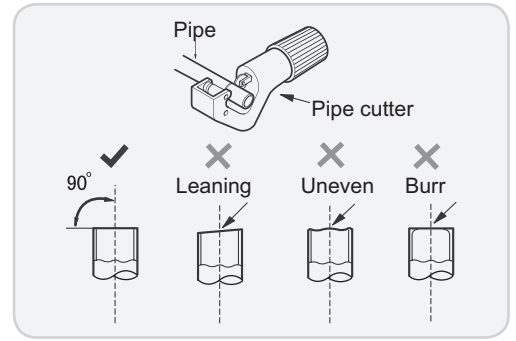

#### B: Remove the burrs

- Remove the burrs with shaper and prevent the burrs from getting into the pipe.

#### C: Put on suitable insulating pipe.

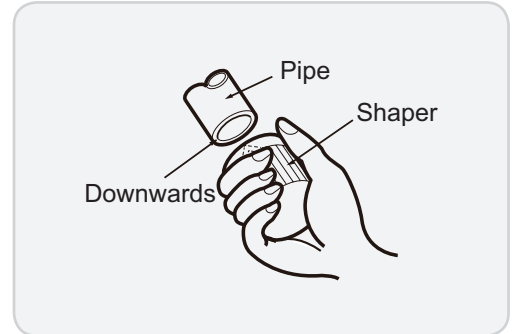

#### D: Put on the union nut

- Remove the union nut on the indoor connection pipe and outdoor valve; install the union nut on the pipe.

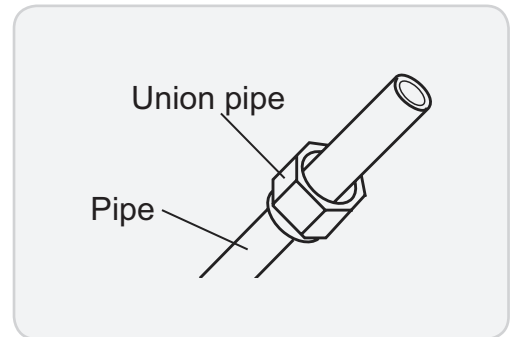

#### E: Expand the port

- Expand the port with expander.

### ⚠ Note:

- "A" is different according to the diameter, please refer to the sheet below:

Outer diameter(mm)	A(mm)	
	Max	Min
Φ6 - 6.35 (1/4")	1.3	0.7
Φ9 - Φ9.52 (3/8")	1.6	1.0
Φ12 - 12.70 (1/2")	1.8	1.0
Φ16 - 15.88 (5/8")	2.4	2.2

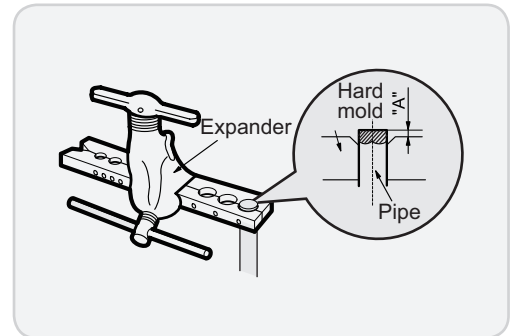

#### F: Inspection

- Check the quality of expanding port. If there is any blemish, expand the port again according to the steps above.

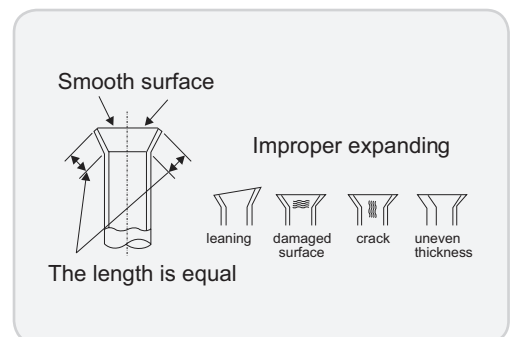

## Appendix 4: List of Resistance for Temperature Sensor

### Resistance Table of Ambient Temperature Sensor for Indoor and Outdoor Units(15K)

Temp(°C)	Resistance(kΩ)
-19	138.10
-18	128.60
-16	115.00
-14	102.90
-12	92.22
-10	82.75
-8	74.35
-6	66.88
-4	60.23
-2	54.31

Temp(°C)	Resistance(kΩ)
0	49.02
2	44.31
4	40.09
6	36.32
8	32.94
10	29.90
12	27.18
14	24.73
16	22.53
18	20.54

Temp(°C)	Resistance(kΩ)
20	18.75
22	17.14
24	15.68
26	14.36
28	13.16
30	12.07
32	11.09
34	10.20
36	9.38
38	8.64

Temp(°C)	Resistance(kΩ)
40	7.97
42	7.35
44	6.79
46	6.28
48	5.81
50	5.38
52	4.99
54	4.63
56	4.29
58	3.99

### Resistance Table of Tube Temperature Sensors for Indoor and Outdoor (20K)

Temp(°C)	Resistance(kΩ)
-19	181.40
-15	145.00
-10	110.30
-5	84.61
0	65.37
5	50.87
10	39.87
15	31.47

Temp(°C)	Resistance(kΩ)
20	25.01
25	20.00
30	16.10
35	13.04
40	10.62
45	8.71
50	7.17
55	5.94

Temp(°C)	Resistance(kΩ)
60	4.95
65	4.14
70	3.48
75	2.94
80	2.50
85	2.13
90	1.82
95	1.56

Temp(°C)	Resistance(kΩ)
100	1.35
105	1.16
110	1.01
115	0.88
120	0.77
125	0.67
130	0.59
135	0.52

### Resistance Table of Discharge Temperature Sensor for Outdoor(50K)

Temp(°C)	Resistance(kΩ)
-30	911.400
-25	660.8
-20	486.5
-15	362.9
-10	274
-5	209
0	161
5	125.1

Temp(°C)	Resistance(kΩ)
10	98
15	77.35
20	61.48
25	49.19
30	39.61
35	32.09
40	26.15
45	21.43

Temp(°C)	Resistance(kΩ)
50	17.65
55	14.62
60	12.17
65	10.18
70	8.555
75	7.224
80	6.129
85	5.222

Temp(°C)	Resistance(kΩ)
90	4.469
95	3.841
100	3.315
105	2.872
110	2.498
115	2.182
120	1.912
125	1.682

**REGULATION (EU) No. 517/2014 - F-GAS**

The unit contains R32, a fluorinated greenhouse gas with global warming potential (GWP) = 675. Do not release R32 into the atmosphere.

**X3I ECO PLUS 27 SH - Kg. 0,53 = 0,357 Tonn CO<sub>2</sub> equiv.**

**X3I ECO PLUS 35 SH - Kg. 0,57 = 0,384 Tonn CO<sub>2</sub> equiv.**

**X3I ECO PLUS 52 SH - Kg. 0,82 = 0,553 Tonn CO<sub>2</sub> equiv.**

**X3I ECO PLUS 70 SH - Kg. 1,5 = 1,0125 Tonn CO<sub>2</sub> equiv.**



Argoclima assumes no responsibility for any errors or inaccuracies in the content of this manual and reserves the right to make any changes to this manual at any time and without notice, deemed appropriate for any technical or commercial need.