



improve your life

CE

EN

# DRY PURY EVO WF 31

DEHUMIDIFIER



## OPERATING INSTRUCTIONS

---

Read the instructions carefully before operating the appliance or carrying out maintenance work. Observe all the safety instructions; failure to do so may lead to accidents and/or damage. Store these instructions in a safe place for future reference.



Appliance is filled with flammable gas R290.

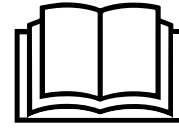

Before installing and using the appliance, read the owner manual.



Before installing the appliance, read the installation manual.



Any repairs you need, contact the nearest authorized Service Centre and strictly follow manufacturer's Service Manual.

## THE REFRIGERANT R290

- To realize the function of the air conditioner unit, a special refrigerant circulates in the system. The refrigerant is the fluoride R290 = 3 GWP (Global warming potential). This refrigerant is flammable and inodorous. It can lead to explosions under certain conditions, however the flammability of this refrigerant is very low and it can be ignited only by fire.
- Compared to other common refrigerants, R290 is a non-polluting refrigerant with no harm to the ozoneosphere and a no effect upon the greenhouse effect. R290 has very good thermodynamic features which lead to a really high energy efficiency. The units therefore need less filling.

### Warning:

Do not try to accelerate the defrosting process or to clean the appliance in different ways other than those recommended by the manufacturer.

Should repair be necessary, contact your nearest authorized Service Centre.

Any repairs carried out by unqualified personnel may be dangerous.

The appliance has to be stored in a room that doesn't have any continuously operating ignition sources. (for example: open flames, an operating gas appliance or an operating electric heater.)

Do not pierce or burn.

Appliance has to be installed, used and stored in a room with a floor area larger than 4 m<sup>2</sup>.

The appliance contains flammable R290 gas.

Attention, refrigerant have no smell.



## GENERAL OPERATING AND SAFETY INSTRUCTIONS

- This appliance is a highly efficient dehumidifier, designed for domestic use only!
- Use this dehumidifier only as outlined in this manual. Any other use not recommended by the manufacturer may cause fire, electric shock or malfunctions.
- The unit contains refrigerant; keep it vertical at all times.
- Once you have opened the unit, keep it vertical to allow the refrigerant to stabilise and wait two hours before operating it.
- Ensure that the required voltage and frequency (220-240V~50Hz) match the available power source.
- Fuse Type: 31TC, 4T, 334, L3CT or 4F, the electricity passing through the fuse cannot be greater than 2A or 3.15A (refer to the data indicated on the product data label).
- This appliance can be used by children aged from 8 years and above and people with reduced physical, sensory or mental capabilities or lack of experience and knowledge if they have been given supervision or instruction concerning use of the appliance in a safe way and understand the hazards involved.
- Children shall not play with the appliance.
- Cleaning and user maintenance shall not be made by children without supervision.
- Make sure the plug is inserted fully. Do not use multiple adapters.
- Do not touch the plug with wet hands. Make sure the plug is clean.
- Children aged between 3 and 8 years must only be able to turn the appliance on/off, provided that the appliance has been placed in its normal operating position, that instructions have been given on how to use the equipment safely, and that its risks have been understood.
- Children aged between 3 and 8 years must not be able to plug in, adjust, clean or perform any maintenance on the appliance.
- Disconnect the mains power when the appliance is not in use or during cleaning operations. Keeping the appliance plugged in may cause electric shocks or accidents.
- To disconnect the appliance, turn off the unit by pressing the POWER button and remove the plug from the socket. Only pull on the plug. Do not pull the cord.

- Do not bend, drag or twist the cord, or apply force to remove it.
- **Do not operate the unit if its cable or plug are damaged;** doing so can cause fires or electric shock. If the power cord is damaged, it must be replaced by a service centre.
- Do not place heavy objects on top of the appliance.
- To prevent water spills, empty the water tank before moving the appliance.
- Do not tilt the dehumidifier onto one side or turn it upside down, as the water which runs out could damage the appliance.
- Do not operate the unit on unstable or sloping surfaces: water leaks can cause it to malfunction or cause excessive vibration and running noise.
- The dehumidifier must be positioned at least 50 cm away from the wall or other obstacles, so that the heat can dissipate correctly.
- Close all open windows to maximise dehumidification efficiency.
- Do not insert objects or sharp instruments into the air outlet grille.
- Do not cover the air intake and outlet grilles in any way.

## **WARNING!**

**In the event of an anomaly, switch the appliance off and unplug it immediately. Do not dismantle, repair or modify this product freely.**

**In the event of a malfunction, contact the aftersales service centre directly.**

- Do not immerse the power cord, plug or any other part of the appliance in water or other liquids.
- Do not expose the dehumidifier to direct sunlight.
- Keep the appliance well away from sources of heat which could cause plastic parts to become warped.
- Do not spray insecticides, oils or paints near the appliance; doing so may damage its plastic parts or start a fire.
- Keep flammable gases and oils away from the appliance!
- Do not move the appliance while it is operating; doing so can cause leaks and malfunction.
- In the event of interference with other electrical appliances, place the two products at a minimum distance of 70 cm.
- This appliance is not intended for use by persons (including children) with reduced physical, sensory or mental capabilities, or lack of experience

and knowledge, unless they have been given supervision or instruction concerning use of the appliance by a person responsible for their safety.

- Children should be supervised to ensure that they do not play with the appliance.

## DESCRIPTION OF THE APPLIANCE

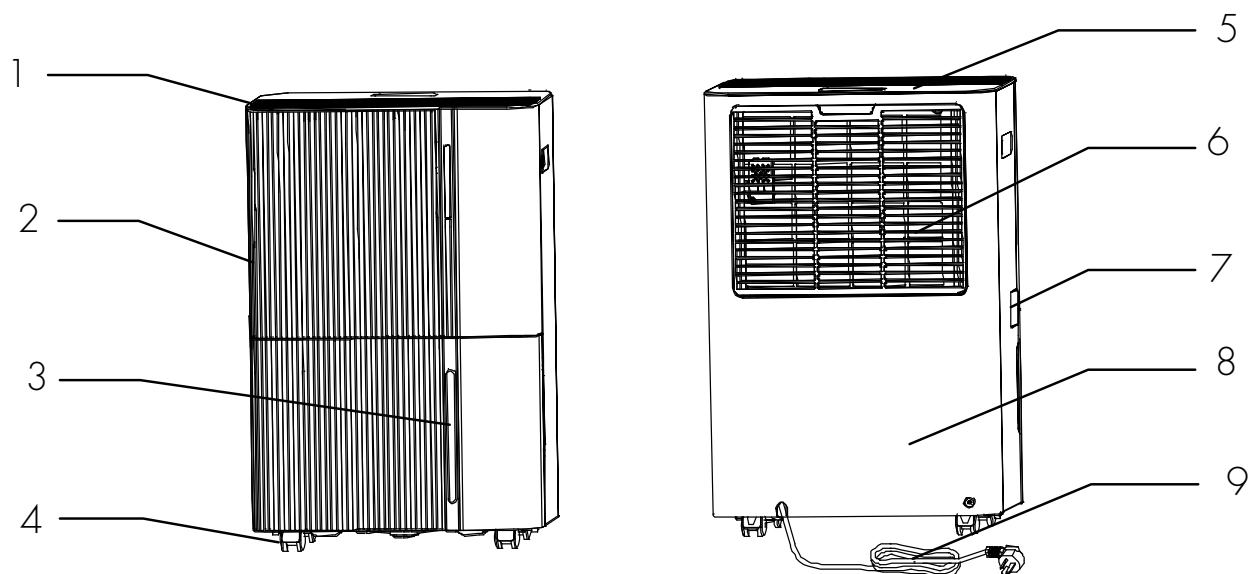

1. Air outlet
2. Front panel
3. Water tank level indicator
4. Castors
5. Control panel

6. Air inlet and dust filter + activated carbon filter
7. Continuous condensate drainage hole
8. Rear panel
9. Power cable

## PRE-OPERATING CHECKS AND OPERATIONS

The following space must be maintained to ensure the operating efficiency of the dehumidifier.

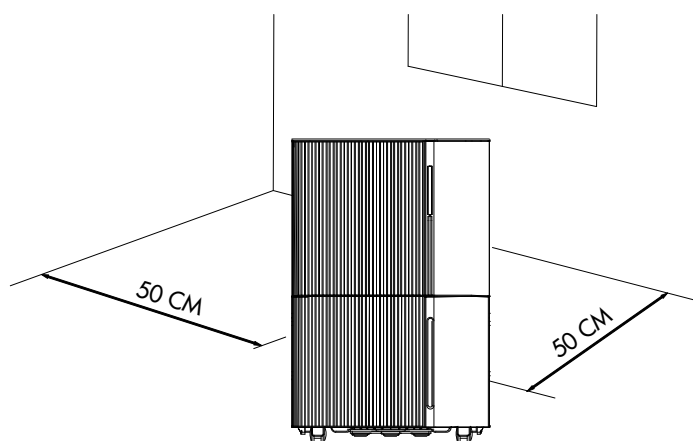

## APPLIANCE START-UP

Place the product on a flat and stable heat-resistant surface, at least 1 metre away from flammable or heat-sensitive materials and 50 cm away from walls or other obstructions.

Make sure the water tank is in the correct position.

Connect the power cord to a suitable electric socket (220-240V~).

Turn the appliance on with POWER on the control panel. The unit emits a sound signal and is in standby, the colored LED strip on the side lights up. The display shows the humidity % detected in the room, therefore set a humidity % lower than at least 3% compared to that in the room to make the dehumidifier work.

The dehumidifier is designed to operate at ambient temperatures from **+ 5°C to + 35°C**.

If it is operated at low temperatures, ice may form on the evaporator, degrading its operation.

When this happens, the dehumidifier goes into defrost mode. The compressor stops, but the fan continues running.

The defrosting operation may start up and operate for some minutes; during the defrosting operation, the dehumidification function may intermit: please don't turn off the switch or pull out the power plug of the dehumidifier.

**We recommend not using the dehumidifier in room temperatures lower than 5°C.**

Do not remove the tank when the unit is in operation.

If you wish to make continuous draining of condensate, follow the instructions in the dedicated paragraph.

## OPERATING PRECAUTIONS

The dehumidifier starts only if the humidity level in the room is higher than 3% the set one.

The dehumidifier will continue to operate until the set humidity level is reached, except for any interruptions due to filling the tank.

When the water tank is full, the compressor stops running immediately and dehumidification stops; the fan stops after 3 minutes. Empty the tank and reposition it: after carrying out these operations, the unit will start operating again.

### ATTENTION:

**After each interruption of operation, at least 3 minutes must elapse before the dehumidifier restarts: this startup delay protects the compressor from damage.**

If, on the other hand, the humidity% set is higher than that present in the room, the dehumidifier will not start.

If, after following the instructions for starting the dehumidifier, the dehumidifier does not start and the (POWER) symbol does not light up, or the dehumidifier stops without reason, check that the condition of the plug and the power cord are good. Once this is done, wait 10 minutes and then restart the dehumidifier.

If, even after 10 minutes, the dehumidifier does not start, or if the cable or the plug are damaged, switch off the dehumidifier and contact a technical assistance center.

### WARNING:

**When the dehumidifier is running, the compressor produces heat and the appliance emits warm air into the room. The room temperature will therefore tend to increase. This is completely normal.**

## SWITCHING OFF THE DEHUMIDIFIER

To turn the dehumidifier off press the POWER button. This shuts off power to the unit.

Unplug the appliance if you do not intend to use it for some time.

## HOW TO ELIMINATE CONDENSATE

The water extracted from the air can be collected in the provided front tank.

When the tank is full, not inserted or not inserted correctly, the full tank alarm LED  turns on and flashes for 5 seconds, emits 5 beeps at the end of which the unit switches off. "FL" appears on the display. The LED strip located on the front of the product turns red.

To switch off the appliance, press the POWER button and wait a few seconds.

1. Carefully pull out the tank.
2. Empty the tank and dry it thoroughly.
3. Reposition the tank
4. Press the POWER button again to turn on the unit.

If the full tank LED remains lit even after emptying the tank, check that the float, which is inside the tank, is correctly positioned.

Make sure not to damage the float, otherwise the unit will not automatically stop working when the water tank is full, and the water could leak out and risk wetting the floor and damage the appliance.

Do not use the drainage pipe when you want to collect the condensate in the tank, otherwise the water could come out from the pipe.

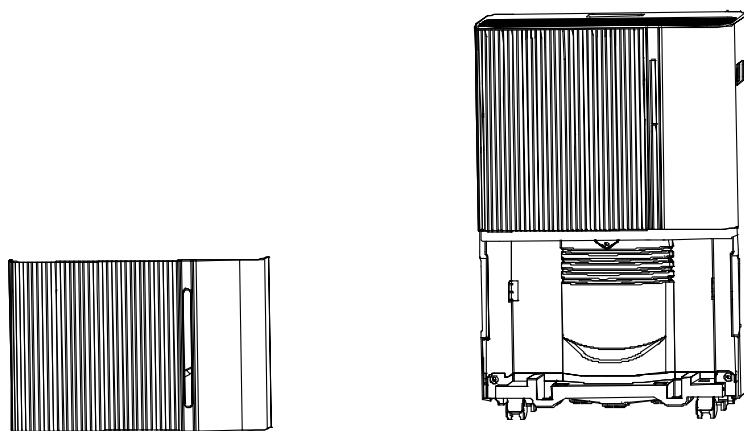

Warning: Do not discard water tank magnets and plastic rivets. Otherwise, the machine will not automatically stop working when the water tank is full, and the condensed water will overflow and damage the floor of the room.

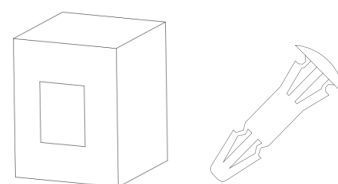

## CONTINUOUS CONDENSATE DRAINAGE

The water can be continuously drained when using a PVC hose with an inner diameter of 11 mm (supplied).

Turn off the appliance and remove the plug before connecting the hose.

Connect the tube to the condensate drain hole (open the little door covering the hole on the side of the product) securely and prepare a container that can hold the water. The tube must be connected without bends or kinks, to facilitate an easy drainage of the condensate, and must be positioned at a greater height than the drain hole.

When disconnecting the hose, prepare a container to collect any residual water that may leak out of the hose.

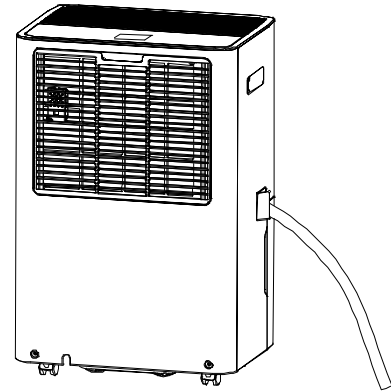

## CONTROL PANEL

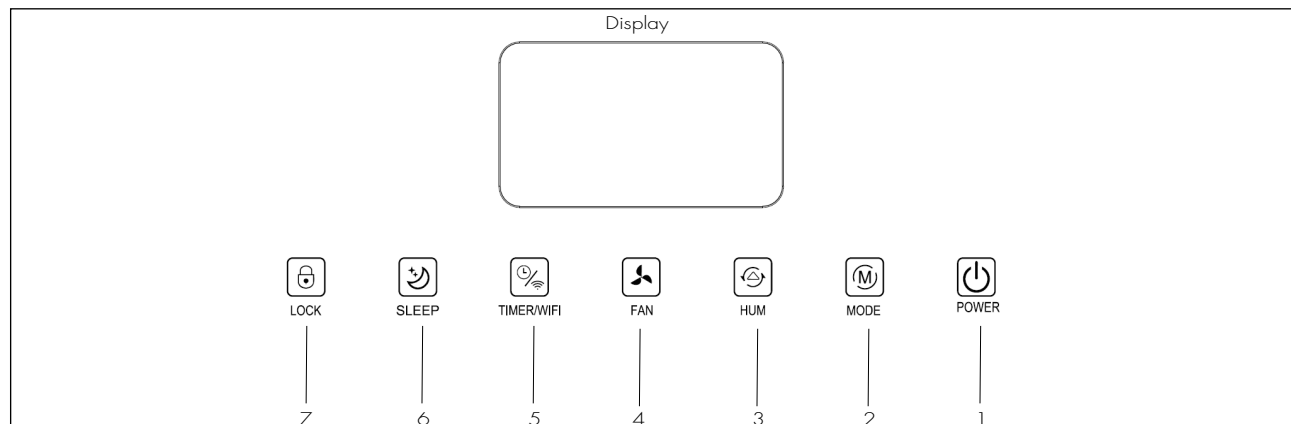

1. Power button
2. Mode button
3. Humidity button
4. Fan Speed button
5. Timer/Wifi button
6. Sleep button
7. Lock button

### 1. POWER BUTTON

After connecting the appliance to the power supply, the machine goes into stand-by mode, then press this button to turn on the dehumidifier, the red LED located under the button remains on during operation. All the LEDs on the control panel light up, by default the fan speed is high, and the set % humidity is 50%.

Press this button to turn off the unit, the LEDs on the control panel turn off, the compressor stops while the fan continues to run for approximately 30 seconds before turning off.

### 2. MODE BUTTON

Press this button to select the operating mode in the following circular sequence: Auto - Laundry. The corresponding LEDs on the control panel will light up according to your selection.

- **Auto mode:** Press the Mode button on the control panel to select the automatic mode, which regulates the operation of the appliance based on the % humidity detected in the room. The LED  lights up on the control panel. When the humidity in the room is greater than or equal to 3% of the set value, the fan and the compressor start working after 3 seconds.

On the other hand, when the humidity in the room is less than or equal to 3% of the set value, the compressor stops while the fan continues to operate for a short period of time.

In Auto mode it is possible to adjust the fan speed with the FAN button and the humidity level with the HUM button. After setting the desired humidity %, the display will return to showing the % of humidity in the room.

- **Laundry mode:** Press the Mode button to activate the Laundry mode, the icon  lights up on the control panel. The unit operates continuously regardless of the humidity level.



### 3. HUMIDITY BUTTON (HUM)

Press this button to view the % humidity in the room. Press this button again to adjust the desired humidity from 30% to 80% in 5% steps.

After making the adjustment, the set % will flash on the display for 3 seconds, thus confirming the successful setting, the display will then go back to showing the % humidity in the room.

By holding this button down for 3 seconds, the temperature in the room is shown on the display.

This button can be used also to set the Timer, each time you press this button you can set the Timer in 1 hour intervals (from 0 to 24 hours).

### 4. FAN SPEED BUTTON

Press this button to adjust the fan speed in the following circular sequence: High - Low.

The corresponding LEDs light up on the control panel according to the selection made.

### 5. TIMER/WIFI BUTTON

#### Timer Function

Press this button to program switching on (if the unit is off) or switching off (if the unit is on) from 0 to 24 hours.

The display flashes. Press the HUM button to set the desired time, each time it is pressed the adjustment interval corresponds to 1 hour, and it is possible to view the set time on the display. To deactivate the Timer, "00" must appear on the display (it flashes 4 times), and the Timer symbol on the control panel will switch off.

#### Wifi Function

Press and hold this button to start network setup or disconnect WIFI. When the Wifi LED flashes on the control panel it is possible to connect the Wifi. If no connection is made within 3 minutes, the LED will stop flashing, and connection will not be possible. Press and hold this key again to connect Wifi.

Once the appliance has been successfully connected, the WIFI lamp lights up. Now you can operate the appliance using the app. Press and hold the "Timer" button for about 5 seconds, the appliance disconnect, the WIFI lamp lights off.

### 6. SLEEP BUTTON

Press this button to activate or deactivate the Sleep function. When this mode is activated, if no selections are made within 10 seconds of activation, the LEDs on the control panel and the display turn off. To reactivate the lighting, press any button on the control panel. The dehumidifier operates in Auto mode and it is possible to adjust the fan speed and the humidity % and it is possible to display any error code.

In Sleep mode, if the water tank should fill up, the machine stops operation and the full tank LED lights up on the control panel, it is therefore necessary to proceed with emptying the tank.

### 7. CHILD LOCK BUTTON

Press this button for 3 seconds to activate the control panel lock function, the LED on the control panel lights up, and it is no longer possible to make selections on the control panel. Press this button again for 3 seconds to deactivate this function, the LED goes out.

When this function is set, it is not possible to turn off the appliance with the Power button.

When the appliance is switched off, the child lock function is automatically deactivated.

### MEMORY FUNCTION

The dehumidifier keeps the last settings selected before switching off or black out.

### COLORED LED STRIP

Inside the front decorative detail of the dehumidifier there is a LED strip which colors differently according to the level of humidity detected in the environment:

Blue = Ambient humidity lower than 45%

Green = Ambient humidity between 45% and 65%

Red = Ambient humidity higher than 65%

If the error codes E1/E2 appear on the display on the control panel, the side LED strip will be red (for error codes, refer to the troubleshooting section).

When the water tank is full, the LED strip maintains the same color as the % of humidity detected in the environment.

## WIFI GUIDE

### INFORMATION ON THE APP "SMART LIFE"

The "Smart Life" App Is Available For Android And Ios.  
Scan The Corresponding Qr Code To Get Directly To The Download.



Download Smart Life App

### INFORMATION ON HOW TO USE THE APP

This appliance allows you to operate the appliance via your home network. A prerequisite is a permanent WIFI connection to your router and the free app "Smart Life".

1. Install the "Smart Life" app. Create a user account.
2. Activate the WIFI function in the settings of your appliance.
3. Place the appliance at a distance of about 5 meters to your router.
4. Long press the "timer" button to start the network configuration, when the WIFI indicator flashes, you can connect the WIFI.

### WIFI CONNECTED

- **Method 1: Connected via Bluetooth**
  - Open the bluetooth of your mobile phone or other device.
  - When WIFI indicator flashes, open "Smart Life" APP, the unit will connected via bluetooth automatically.
- **Method 2:**
  - When WIFI indicator flashes, select "Add Device"- "Small Home Appliances"- "Dehumidifier", and follow the instructions on the display.
  - Check the status of the WIFI indicator and choose the correct status.
  - If the WIFI indicator flash rapidly, it can connected directly.
  - If the WIFI indicator flash slowly, press "Go to Connect" to connect the WIFI named "SmartLife-XXXX", then back to the APP, the WIFI will connect ok.

**Remarks:** Once the appliance has been successfully connected, the WIFI lamp lights up. Now you can operate the appliance using the app.

Press and hold the Timer button for about 5 seconds, the appliance disconnect, the WIFI lamp lights off.

## CARE AND MAINTENANCE

### Cleaning the external surface

**Warning:** Always remove the plug from the socket before cleaning the dehumidifier, otherwise electric shock or malfunction may occur.

**Warning:** Do not wet or immerse the dehumidifier in water otherwise electric shock may occur.

Use a soft, damp cloth to clean the outside of the dehumidifier.

Do not use solvents, petrol, xylene, talcum powder and brushes: they could damage the surface or the color of the case.

### Cleaning the water tank

It is advisable to remove the tank every fifteen days to prevent the formation of mold and bacteria. Fill the water tank with clean water and a small amount of detergent, empty and rinse it.

### Double filtration system maintenance

The product is equipped with a double filtration system: anti-dust filter + active carbon filter.

### Cleaning the dust filter located on the air inlet

The dust filter has an important function in retaining the main allergens.

Cleaning the dust filter should be done every two weeks of operation.

The function of the filter is to filter the dust or dirt present in the air, therefore if the filter is blocked by dust the electricity consumption will be higher than normal.

1. Remove the filter by releasing it from its seat (Fig.1).
2. Gently clean the filter with a vacuum cleaner to remove dust. If necessary, wash the filter with warm soapy water **DO NOT USE ALCOHOL, BENZENE OR OTHER AGGRESSIVE PRODUCTS** (Fig.2).  
Leave the filter to dry naturally, then insert it back into its housing (Fig.3).  
Do not use hair dryer or fire to dry the filter.  
Do not use sponges or brushes to clean the filter as they can damage it.
3. Replace the filter and resume normal operation of the appliance.

Do not use the dehumidifier without the filter, because the dust could affect the efficiency of the evaporator and cause higher energy consumption.

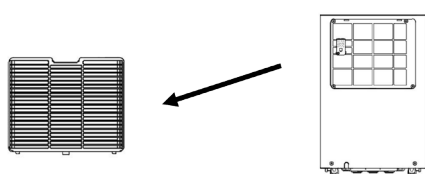

Fig.1

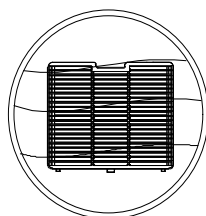

Fig.2

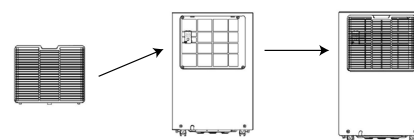

Fig.3

### Maintenance of the additional activated carbon filter

The activated carbon filter is particularly effective in eliminating bad odours. However, proper maintenance is required.

The filter should be replaced after approximately 600 hours of operation.

Spare parts are available at authorized technical assistance centres.

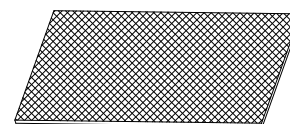

## CONSERVATION AND STORAGE

If the unit is not used for a long period of time, it is necessary to carry out the following operations before storing it.

1. Turn off the device with the Power button and unplug the power cord from the power outlet.
2. Eliminate the water deposited in the water tank and dry it thoroughly
3. Clean the air filter and let it dry completely
4. Place the power cord in the water tank
5. Replace the filter
6. Store the device in an upright position and in a cool, dry and ventilated place.

### Troubleshooting

In the event of malfunctions, before contacting an Authorized Service Centre, check the table below to see if it is possible to solve some problems:

Problem	Possible cause	Solution
The dehumidifier is not working	The internal tank is full. The plug it's not correctly connected The ambient temperature is below 5°C or above 35°C	Empty the tank and position the tank correctly. Connect the plug. The appliance cannot operate over these temperature limits, therefore the machine protection is activated. When the temperature is equal to or lower than 16°C the dehumidifier activates the defrosting process at intervals, when this occurs the compressor stops but the fan continues to operate
The noise increases suddenly during operation	The unit is placed on an uneven surface. The air filter is clogged	Place the unit on a level and stable surface.  Clean the filter
Reduced dehumidification effect	The filter is full of dust. The air inlet and outlet are blocked	Clean the filter. Remove objects blocking the air inlet and outlet.
E1/E2	Humidity sensor problem	Contact a service center to replace the sensor
FL	Water tank full alarm	Empty the water tank

REGULATION (EU) N. 517/2014 - F-GAS

DRY PURY EVO WF 31

The unit contains R290, a natural greenhouse gas with global warming potential (GWP) = 3 - Kg. 0,078 = 0,000234 Tonn CO<sub>2</sub> equiv. Do not release R290 into the atmosphere.



**INFORMATION FOR CORRECT DISPOSAL OF THE PRODUCT IN ACCORDANCE WITH THE EUROPEAN DIRECTIVE 2012/19/EU**

At the end of its working life this equipment must not be disposed of as an household waste. It must be taken to special local community waste collection centres or to a dealer providing this service. Disposing of electrical and electronic equipment separately avoids possible negative effects on the environment and human health deriving from an inappropriate disposal and enables its components to be recovered and recycled to obtain significant savings in energy and resources. In order to underline the duty to dispose of this equipment separately, the product is marked with a crossed-out dustbin.

# SPECIALIST'S MANUAL

## Aptitude requirement for maintenance man (repairs. should be done only be specialists).

- Any person who is involved with working on or breaking into a refrigerant circuit should hold a current valid certificate from an industry-accredited assessment authority, which authorises their competence to handle refrigerants safely in accordance with an industry recognised assessment specification.
- Servicing shall only be performed as recommended by the equipment manufacturer. Maintenance and repair requiring the assistance of other skilled personnel shall be carried out under the supervision of the person competent in the use of flammable refrigerants.

## Safety preparation work

The maximum refrigerant charge amount is shown on the following table a  
(Note: Please refer to the nameplate for the charging quantity of R290).

Room area (m <sup>2</sup> )	4	11	15
Maximum charge (kg)	<0.152	0.225	0.304

Table a - Maximum charge (kg)

## Security checks

Prior to beginning work on systems containing flammable refrigerants, safety checks are necessary to ensure that the risk of ignition is minimised. For repair to the refrigerating system, the following precautions shall be complied with prior to conducting work on the system.

- **Work procedure**  
Work shall be undertaken under a controlled procedure so as to minimise the risk of a flammable gas or vapour being present while the work is being performed.
- **General work area**  
All maintenance staff and others working in the local area shall be instructed on the nature of work being carried out. Work in confined spaces shall be avoided. The area around the workspace shall be sectioned off. Ensure that the conditions within the area have been made safe by control of flammable material.
- **Checking for presence of refrigerant**  
The area shall be checked with an appropriate refrigerant detector prior to and during work, to ensure the technician is aware of potentially toxic or flammable atmospheres. Ensure that the leak detection equipment being used is suitable for use with all applicable refrigerants, i.e. non-sparking, adequately sealed or intrinsically safe.
- **Presence of fire extinguisher**  
If any hot work is to be conducted on the refrigeration equipment or any associated parts, appropriate fire extinguishing equipment shall be available to hand. Have a dry powder or CO<sub>2</sub> fire extinguisher adjacent to the charging area.
- **No ignition sources**  
No person carrying out work in relation to a refrigeration system which involves exposing any pipe work shall use any sources of ignition in such a manner that it may lead to the risk of fire or explosion. All possible ignition sources, including cigarette smoking, should be kept sufficiently far away from the site of installation, repairing, removing and disposal, during which refrigerant can possibly be released to the surrounding space. Prior to work taking place, the area around the equipment is to be surveyed to make sure that there are no flammable hazards or ignition risks. "No Smoking" signs shall be displayed.
- **Ventilated area**  
Ensure that the area is in the open or that it is adequately ventilated before breaking into the system or conducting any hot work. A degree of ventilation shall continue during the period that the work is carried out. The ventilation should safely disperse any released refrigerant and preferably expel it externally into the atmosphere.
- **Checks to the refrigeration equipment**  
Where electrical components are being changed, they shall be fit for the purpose and the correct specification. At all times the manufacturer's maintenance and service guidelines shall be followed. If in doubt, consult the

manufacturer's technical department for assistance.

The following checks shall be applied to installations using flammable refrigerants:

- The actual refrigerant charge is in accordance with the room size within which the refrigerant containing parts are installed;
- The ventilation machinery and outlets are operating adequately and are not obstructed;
- If an indirect refrigerating circuit is being used, the secondary circuit shall be checked for the presence of refrigerant;
- Marking to the equipment continues to be visible and legible. Markings and signs that are illegible shall be corrected;
- Refrigeration pipe or components are installed in a position where they are unlikely to be exposed to any substance which may corrode refrigerant containing components, unless the components are constructed of materials which are inherently resistant to being corroded or are suitably protected against being so corroded.

- **Checks to electrical devices**

Repair and maintenance to electrical components shall include initial safety checks and component inspection procedures. If a fault exists that could compromise safety, then no electrical supply shall be connected to the circuit until it is satisfactorily dealt with. If the fault cannot be corrected immediately but it is necessary to continue operation, an adequate temporary solution shall be used. This shall be reported to the owner of the equipment so all parties are advised.

Initial safety checks shall include:

- That capacitors are discharged: this shall be done in a safe manner to avoid possibility of sparking;
- That no live electrical components and wiring are exposed while charging, recovering or purging the system;
- That there is continuity of earth bonding.

- **Repairs to sealed components**

During repairs to sealed components, all electrical supplies shall be disconnected from the equipment being worked upon prior to any removal of sealed covers, etc. If it is absolutely necessary to have an electrical supply to equipment during servicing, then a permanently operating form of leak detection shall be located at the most critical point to warn of a potentially hazardous situation. Particular attention shall be paid to the following to ensure that by working on electrical components, the casing is not altered in such a way that the level of protection is affected. This shall include damage to cables, excessive number of connections, terminals not made to original specification, damage to seals, incorrect fitting of glands, etc.

- Ensure that the apparatus is mounted securely.
- Ensure that seals or sealing materials have not degraded to the point that they no longer serve the purpose of preventing the ingress of flammable atmospheres. Replacement parts shall be in accordance with the manufacturer's specifications.

NOTE: the use of silicon sealant can inhibit the effectiveness of some types of leak detection equipment. Intrinsically safe components do not have to be isolated prior to working on them.

- **Repair to intrinsically safe components**

Do not apply any permanent inductive or capacitance loads to the circuit without ensuring that this will not exceed the permissible voltage and current permitted for the equipment in use. Intrinsically safe components are the only types that can be worked on while live in the presence of a flammable atmosphere. The test apparatus shall bear the correct rating. Replace components only with parts specified by the manufacturer. Other parts may result in the ignition of refrigerant in the atmosphere from a leak.

- **Cabling**

Check that cabling will not be subject to wear, corrosion, excessive pressure, vibration, sharp edges or any other adverse environmental effects. The check shall also take into account the effects of aging or continual vibration from sources such as compressors or fans.

- **Detection of flammable refrigerants**

Under no circumstances shall potential sources of ignition be used in the searching for or detection of refrigerant leaks. A halide torch (or any other detector using a naked flame) shall not be used.

- **Leak detection methods**

The following leak detection methods are deemed acceptable for all refrigerant systems. Electronic leak detectors may be used to detect refrigerant leaks but, in the case of flammable refrigerants, the sensitivity may not be adequate, or may need re-calibration. (Detection equipment shall be calibrated in a refrigerant-free area.) Ensure that the detector is not a potential source of ignition and is suitable for the refrigerant used. Leak detection equipment shall be set at a percentage of the LFL of the refrigerant and shall be calibrated to the refrigerant

employed, and the appropriate percentage of gas (25 % maximum) is confirmed. Leak detection fluids are suitable for use with most refrigerants but the use of detergents containing chlorine shall be avoided as the chlorine may react with the refrigerant and corrode the copper pipe-work. If a leak is suspected, all naked flames shall be removed/extinguished. If a leakage of refrigerant is found which requires brazing, all of the refrigerant shall be recovered from the system, or isolated (by means of shut off valves) in a part of the system remote from the leak. For appliances containing flammable refrigerants, oxygen free nitrogen (OFN) shall then be purged through the system both before and during the brazing process.

- **Removal and evacuation**

When breaking into the refrigerant circuit to make repairs or for any other purpose conventional procedures shall be used. However, for flammable refrigerants it is important that best practice is followed since flammability is a consideration.

The following procedure shall be adhered to:

- remove refrigerant;
- purge the circuit with inert gas; evacuate;
- purge again with inert gas;
- open the circuit by cutting or brazing.

The refrigerant charge shall be recovered into the correct recovery cylinders. For appliances containing flammable refrigerants, the system shall be flushed with OFN to render the unit safe. This process may need to be repeated several times. Compressed air or oxygen shall not be used for purging refrigerant systems. For appliances containing flammable refrigerants, flushing shall be achieved by breaking the vacuum in the system with OFN and continuing to fill until the working pressure is achieved, then venting to atmosphere, and finally pulling down to a vacuum. This process shall be repeated until no refrigerant is within the system. When the final OFN charge is used, the system shall be vented down to atmospheric pressure to enable work to take place. This operation is absolutely vital if brazing operations on the pipe-work are to take place. Ensure that the outlet for the vacuum pump is not close to any ignition sources and that ventilation is available.

- **Charging procedures**

In addition to conventional charging procedures, the following requirements shall be followed.

- Ensure that contamination of different refrigerants does not occur when using charging equipment. Hoses or lines shall be as short as possible to minimise the amount of refrigerant contained in them.
- Cylinders shall be kept upright.
- Ensure that the refrigeration system is earthed prior to charging the system with refrigerant.
- Label the system when charging is complete (if not already).
- Extreme care shall be taken not to overfill the refrigeration system.

Prior to recharging the system, it shall be pressure-tested with the appropriate purging gas. The system shall be leak-tested on completion of charging but prior to commissioning. A follow up leak test shall be carried out prior to leaving the site.

- **Decommissioning**

Before carrying out this procedure, it is essential that the technician is completely familiar with the equipment and all its detail. It is recommended good practice that all refrigerants are recovered safely. Prior to the task being carried out, an oil and refrigerant sample shall be taken in case analysis is required prior to re-use of reclaimed refrigerant. It is essential that electrical power is available before the task is commenced.

1. Become familiar with the equipment and its operation.
2. Isolate system electrically.
3. Before attempting the procedure, ensure that:
  - mechanical handling equipment is available, if required, for handling refrigerant cylinders;
  - all personal protective equipment is available and being used correctly;
  - the recovery process is supervised at all times by a competent person;
  - recovery equipment and cylinders conform to the appropriate standards.
4. Pump down refrigerant system, if possible.
5. If a vacuum is not possible, make a manifold so that refrigerant can be removed from various parts of the system.
6. Make sure that cylinder is situated on the scales before recovery takes place.
7. Start the recovery machine and operate in accordance with manufacturer's instructions.
8. Do not overfill cylinders. (No more than 80% volume liquid charge).
9. Do not exceed the maximum working pressure of the cylinder, even temporarily.
10. When the cylinders have been filled correctly and the process completed, make sure that the cylinders and the equipment are removed from site promptly and all isolation valves on the equipment are closed off.
11. Recovered refrigerant shall not be charged into another refrigeration system unless it has been cleaned and



checked.

- **Labelling**

Equipment shall be labelled stating that it has been de-commissioned and emptied of refrigerant. The label shall be dated and signed. For appliances containing flammable refrigerants, ensure that there are labels on the equipment stating the equipment contains flammable refrigerant.

- **Recovery**

When removing refrigerant from a system, either for servicing or decommissioning, it is recommended good practice that all refrigerants are removed safely. When transferring refrigerant into cylinders, ensure that only appropriate refrigerant recovery cylinders are employed. Ensure that the correct number of cylinders for holding the total system charge are available. All cylinders to be used are designated for the recovered refrigerant and labelled for that refrigerant (i.e. special cylinders for the recovery of refrigerant). Cylinders shall be complete with pressure-relief valve and associated shut-off valves in good working order. Empty recovery cylinders are evacuated and, if possible, cooled before recovery occurs. The recovery equipment shall be in good working order with a set of instructions concerning the equipment that is at hand and shall be suitable for the recovery of all appropriate refrigerants including, when applicable, flammable refrigerants. In addition, a set of calibrated weighing scales shall be available and in good working order. Hoses shall be complete with leak-free disconnect couplings and in good condition. Before using the recovery machine, check that it is in satisfactory working order, has been properly maintained and that any associated electrical components are sealed to prevent ignition in the event of a refrigerant release. Consult manufacturer if in doubt. The recovered refrigerant shall be returned to the refrigerant supplier in the correct recovery cylinder, and the relevant waste transfer note arranged. Do not mix refrigerants in recovery units and especially not in cylinders. If compressors or compressor oils are to be removed, ensure that they have been evacuated to an acceptable level to make certain that flammable refrigerant does not remain within the lubricant. The evacuation process shall be carried out prior to returning the compressor to the suppliers. Only electric heating to the compressor body shall be employed to accelerate this process. When oil is drained from a system, it shall be carried out safely.



improve your life

[www.argoclima.com](http://www.argoclima.com)

Argoclima assumes no responsibility for any errors or inaccuracies in the content of this manual and reserves the right to make to this, at any time and without notice, any changes deemed appropriate for any technical or commercial need.